

AVL03 User Guide

Automatic Vehicle Location



I. Welcome to use this car product

- **We keep the final explanation right on this User Guide.**
- **Please don't unfold or maintain it, for fear damaging it, if you don't operate it according to the user's manual, it may damage the product or cause hurt to you, our company would not take responsibility for the loss in this situation.**
- **Our tracking devices may not be used to violate the privacy rights of others, or in violation of local, county, state or federal statutes, and our company will not be responsible for inappropriate use of these products.**
- **AVL is a device that uses the Global Positioning System to determine the precise location of a vehicle, moving house, trailer or other asset which AVL is installed on and to record the position of the AVL at regular intervals. With Sirf Star III GPS systems, it records not only position, but also velocity, Date time, direction, status of digital output ports, etc.**
- **The main purpose of using AVL is not only to locate the vehicles, but also to obtain information about the status of doors, windows and ignition, etc. Or remotely monitor cutting off gas and power supply, etc.**
- **Sometimes, if users want to upgrade the AVL version, then we will give users new software firmware to update it. In this situation, please contact our service center.**

- In order to acquire more important details, you should pay much attention to some signs and supplementary information, such as:

【note】 : Means you must pay much attention, it includes many important details which you may overlook.

【caution】 : Warning information on relative topic, you should read it carefully, for fear causing unwanted loss.

【more information】 : More relative information about a certain topic, sometimes it is another easy way for the same purpose.

And if some words are marked in red color, that indicates the words should be paid much more attention.

Catalog

I. Welcome to use this car product	2
1.1 Introduction.....	5
1.1.1 Key Feature	6
1.2 Accessories	7
1.3 Specification.....	7
1.4 Outside feature	8
1.4.1 Socket and Switch	8
1.4.2 I/O ports.....	10
1.4.3 Connect Relay to control the Car Oil/Power. (port 8)	12
II. Get started, please follow me!	13
2.1 Installation Guide.....	13
2.2 Send instructions and track a vehicle.....	17
2.3 View AVL trace on PC	19
2.3.1 Input position data to map software	19
2.4 GPRS Setting Step by Step	20
2.5 Common questions and solution.....	22
III. Attachment.....	23
3.1 SMS instruction list.....	23
3.2 Update the firmware of the AVL	28
3.2.1 IAP Update User Guide	28
3.3 Worldwide APN (Access Point Name) List.....	34

AVL03 User Guide

V3.23

Thank you for using the car product, which is mainly for tracking the vehicle, anti-thief, and remotely monitoring the car through I/O ports socket of AVL, etc. All of this function can be realized by using a mobile phone, or see the status of your car in a Server via GPRS. According to the user's different need, our company has different version as below:

1.1 Introduction

Software Function	
Single location	✓
Tracking	✓
Over-speed alarm	✓
Geo-fence alarm	✓
Wake up alarm	✓
Sleep alarm	✓
SOS alarm	✓
GPRS Function	✓
Heartbeat function	✓
I/O ports trigger alarm	✓
Low battery alarm	✓
Exterior battery cut off alarm	✓
Physics Speciality	
Inner Lithium battery	✓
Charged by exterior DC	✓
Tremble Sensor-based	✓
Anti-theft Alarm	✓
SOS button or Button A	✓ 1B
Switch input	✓ (1 ports)
Digital input	✓ (2 ports)
Digital output	✓ (2 ports)

1.1.1 Key Feature

In the Basic Version, by using the AVL, user can track the vehicle via SMS or GPRS, supervise the status of the door, window, ignition of the car through I/O sockets. The more detailed function as below:

- **Internal Polymer Lithium Ion Battery in the AVL**
- **Can be charged by exterior DC 12 - 24 V**
- **Exterior battery cut off alarm**
- **Support mini USB port to update firmware**
- **Low power consumption**
- **Over-speed alarm**
- **Geo-fence alarm**
- **Low power alarm**
- **With GSM/GPRS module and Sirf-starIII GPS chipset**
- **Support single location and continual tracking**
- **Can Real-time tracking your vehicle via map on PC**
- **GPRS function, receiving position data and alarm data on Server**
- **Anti-theft alarm, support alarm when someone tremble your car once you park it and send an alarm report to you via SMS or GPRS data**
- **Remotely control the status of the windows or doors close/open, through the 2 switch I/O sockets, and remotely control the status of ignition through the 1 digital I/O socket**
- **SOS button send out exact location for immediate rescue. After user press SOS button in the AVL, AVL unit will send out the location and SOS alarm to the preset number via SMS or a server via GPRS**

1.2 Accessories

Thank you for your purchase of the AVL, after you get it, please checking all the accessories in the box:

	Accessories
GSM Antenna	✓
GPS Antenna	✓
Cables	✓
User Manual CD	✓
Configure Cable	✓

If there is any part damaged or absent, please contact your dealer as soon as possible, and if you have any questions or problems when using it, you can contact our service center.

1.3 Specification

Feature	Characteristics
Dimension	110mm*66mm*27mm
Exterior Power Supply	DC 12V -- 24V
Inner lithium battery	DC 3.8V -- 4.2V
Exterior GSM antenna	Receive GSM signal better
Exterior GPS antenna	Receive GPS signal better
Power Consumption when exterior voltage is 12V	Active mode(avg.) < 100mA Sleep mode < 5mA
Operating Temperature Range	-20°C to +60°C
Air pressure	860Kpa --1060Kpa
Humidity	Up to 75% non-codensing
Position accuracy	10 --15 meters
GSM chip	Simcom, support 4 frequency GSM 850/ 900/1800 /1900MHZ

AVL03 User Guide
V3.23

GPS chip	Sirf-Star III (super-sensitivity and high accuracy)
Tremble Intensity	
LED	3 LEDs indicates GSM, GPS signal, and trembling status
Button(not in the basic version)	2 buttons, report location, quick dial (optional)

1.4 Outside feature

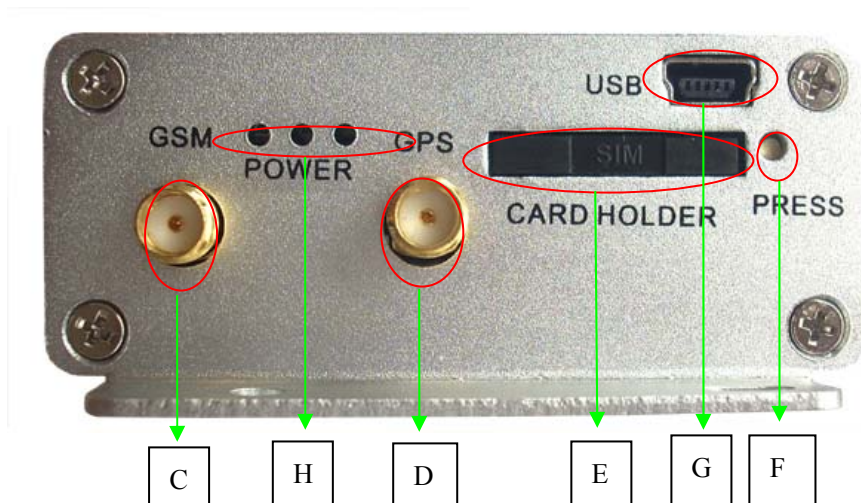
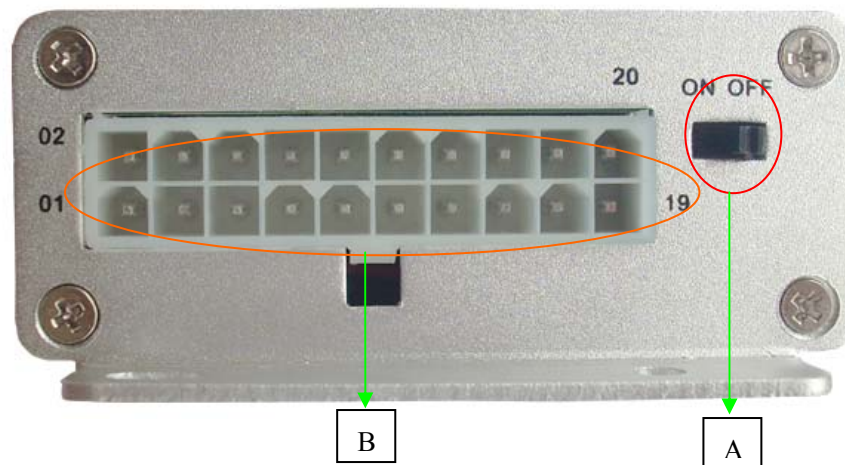

1.4.1 Socket and Switch

Hardware	Function
A. Switch	Open/Close the unit
B. I/O Sockets	Expanding function, as below

AVL03 User Guide
V3.23

C. GSM Antenna socket	Connect Exterior GSM Antenna
D. GPS Antenna socket	Connect Exterior GPS Antenna
E. SIM Card Holder	Hold a SIM card
F. Yellow plastic Pin	Press it to pop up the SIM Card Holder
G. USB Port	Support "USB Converter" to update firmware
H. Three LED	GSM LED(Left), Power& tremble Led, GPS Led

1.4.2 I/O ports



2)GND	4)	6)	8)Cut Car Current	10)	12)	14)	16)	18) GND	20)V+ (12V-24V)
1)SOS Button (With GND)	3)Button A (With GND)	5)Digital Output A (12V)	7)Digital Output B (12V)	9) Switch Input 1 (With GND)	11) Switch Input 2 (With GND)	13)Digital input1 (12V)	15)Digital input2 (12V)	(17) Reset	(19)

Notes: The sequence of the 13 sockets in the diagram are for the corresponding sockets in the above picture. Please do not confuse the direction, the Switch is the right side of I/O Sockets. The function is as below:

NO.	Function
I/O 01	When SOS Button cable is connected to GND(port 02), namely trigger, the unit will send out a data via SMS or GPRS, alarm type is "01"
I/O 02	GND, use for input GND
I/O 03	When this cable is connected to GND(port 02), Device will send a GPRS alarm data to Server. (Old Hardware version is Reset button)
I/O 05	Using a phone can set the voltage value of the digital output through "025" instruction, high or low, by virtue of it, user can remote Control the Car window or door close/open
I/O 07	The function is the same as I/O 05
I/O 08	Connect to Relay to control the Cut Current function
I/O 09	When this cable is connected to GND(port 02), Device will send a GPRS alarm data to Server. And when connect is lose , Device also will send a GPRS alarm data to server.
I/O 11	When this cable is connected to GND(port 02), Device will send a GPRS alarm data to Server. And when connect is lose , Device also will send a GPRS alarm data to server.

AVL03 User Guide

V3.23

I/O 13	The function is similar as I/O 09, but the triggered voltage must be high, alarm type is “54”, “55”, through it , user can monitor the status of ignition or Car window status
I/O 15	The function is the same as I/O 13, but the alarm type is “56”, “57”
I/O 17	When this cable is connected to GND(port 18), Device will be RESET (Old Hardware version without this cable)
I/O 18	GND, the voltage is ‘0’, The cathode of power input socket
I/O 20	The anode of power input socket

Note: The port that no mark is leave to customize.

1.4.3 Connect Relay to control the Car Oil/Power. (port 8)

Diagram Of Relay

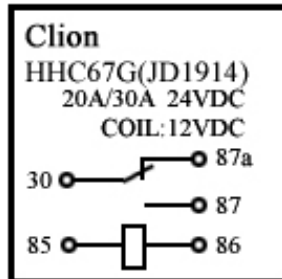

Step:

- 1.Connect AVL port 20 to Car Battery +12V
- 2.Connect AVL port 18 to GND
- 3.Cut off the circle of Car Engine
- 4.Relay port 30 and port 87a connect to Car Engine
- 5.Relay port 85 connect to Car Battery +12V power
- 6.Relay port 86 connect to AVL port 08

Diagram Of AVL

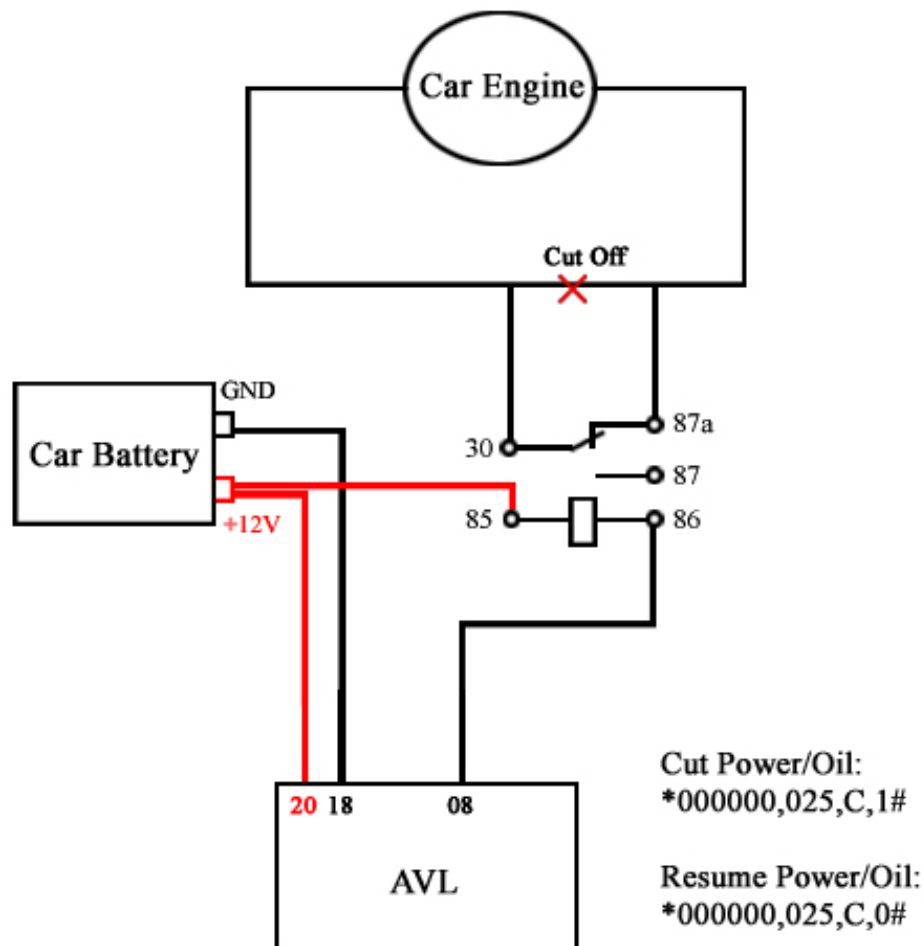

II. Get started, please follow me!

2.1 Installation Guide

♣ Step1: Inset a SIM card.

(1) Using a needle to press the yellow plastic (in the hole), then the cover of SIM card will pop-up, take the slipcover of SIM card out to put the SIM card in it, with the chip module up, as the below pictures shows:



(2) Put back the front cover, and move the sliding cover to the unit.

【note】 :Please make sure the SIM card can communicate with other cards via SMS and call, and before installing the SIM card to the holder, please use a mobile phone to empty the SMS storage of the card.

♣ Step2: Connect GSM Antenna and GPS Antenna to AVL unit.

(1) Fasten the connection by turning the metal end of the antenna, until the connection is very firm.

As the below picture shows, the above socket is for GSM antenna, the below is for antenna in picture 1, picture 2 is GPS antenna, picture 3 is GSM antenna.



Picture 1



Picture 2 (GPS Antenna)



Picture 3 (GSM Antenna)

【note】 : We would better to put the GPS antenna top to the open air out of the car to get more GPR signal, or make sure that it will not be covered or shielded by any electromagnetic object.

【more information】 :AVL relies on GSM and GSP system for location and communication, so we must make sure that GSM signal and GSP signal are in good state.

- GSM is the abbreviation of Global System for Mobile Communication. At first, you should insert a phone (SIM)card into the AVL, In virtue of GSM system, AVL and your mobile phone in hand can communicate with each other.
- GPRS is General Packet Radio Service, is a service technique based on GSM, by virtue of the service, the AVL can communicate with a Server.
- GPS is the abbreviation of Global Positioning System. There are 24 positioning satellites around the earth sending GPS signal to the AVL03 straightly. In order to receive signal, the top of GSP antenna cannot be shielded or covered by any electromagnetic object. The use can bring the top of GPS antenna to the open air for better GPS signal. If AVL03 is in a shielding environment temporary, please don't worry, because once the AVL03 leaves the shielding environment, it will regain GPS signal. Further, the product can

provide accurate position information under dynamic condition, the precision will be kept within 10 to 15 meters.

♣ Step 3: Fix the AVL in your car and connect the AVL to the power of your car.

(1) Connect the wires to the I/O socket, please make sure the wires has inserted to the I/O socket firmly. As below:



(2) look at the above pictures shows, Connect blue wire(I/O11, refer to P10) to the anode of the exterior power of the car, and red wire(I/O20) to the cathode, please note that the exterior voltage must be between 9 V and 36V, please make sure to comply with it.

【more information】 : AVL unit have lithium battery in it, and if AVL is cut off from the power of the car, lithium battery will supply power to the AVL. Once AVL is connected to the car power, lithium battery will be charged until it reaches full.

【caution】 : After you have completed all the process, we must check that the wiring connections are firm and reliable, and the joints are wrapped with insulating tape tightly.

♣ Step 4: Turn on the AVL, observe the three leds in the AVL.

(1) Turn on the AVL, you will see the three leds flash at the same time.

It entered into initial mode.

(2) After about 25 S, the AVL will enter into work mode, Look at the picture, with various status as below.

● LED Indicators



LED1	(green color)	GSM Indicator
LED2	(orange color)	Tremble & Power sensor Indicator
LED3	(blue color)	GPS Indicator

LED	State	Meaning
Tremble sensor LED (orange LED)	light 0.1s dark 0.1s	System Initial
	light	Trembling
GSM LED (green LED)	light 0.1s dark 0.1s	System Initial
	light 0.1s dark 2.9s (flash)	GSM receiver work well
	light 1s dark 2s (glow periodically)	No GSM signal
GPS LED (blue LED)	light 0.1s dark 0.1s	System Initial
	light 0.1s dark 2.9s (flash)	GPS receiver work well
	light 1s dark 2s (glow periodically)	No GPS signal

When AVL is in work mode, if GSM signal is in good state, the green led will flash, similarly, if GPS signal is in good state, the blue led will flash, if the green led is not flashing, that indicates the GSM signal is not good, if the blue led is not flashing, then you should check if there is something upon the GPS antenna top. Further, if you find the three leds are dark, maybe the AVL entered into "sleep-mode" or there is no power in the AVL unit.

2.2 Send instructions and track a vehicle

♣ Ask for a present position of your vehicle

No matter where you are, when you want to know the position of your vehicle, make a telephone call to the AVL, it will report its location to you by SMS, or you can send a SMS to it.

Edit a message as following format, and send it to the AVL:

SMS Format: ***+Password+, +000#** (*init password is : 000000*)

For example: ***000000,000#**

The AVL will send a SMS back to you, including longitude & latitude data.

【note】 : W must be a capital letter, 0 is a number, not a letter. And please do not enter spaces or hyphens in the SMS. And the use must make sure that the AVL unit is not in “sleep” mode.

♣ Modify your password

Before you use the AVL, you should modify your password, for fear controlling the AVL by other people, you can use the "001" instruction.

SMS Format: ***+Password+, +001+, @@@@#@#**

For example: if you want modify your password to 123456, you can send **"*000000,001,123456#"** to the SIM card in the AVL. If you send it successfully, after a few seconds, it will send "Receive:'001'OK *000000,001,123456#" to you automatically. After this, your password will be 123456. Then when you do the next process, you should bear the password in mind.

【note】 : If you have changed your password, the password in SMS command isn't 000000 anymore, it must be the modified password, please note it.

♣ Track your vehicle

Tracking report function can be turned on or off according to the requirements of the user, by using "002" instruction, you can set a time interval (X), report times(Y). That is to say, you can receive position report at X mins interval, and report Y times before it stops.

SMS Format: ***+Password+, +002+, X, +Y #**

For example: ***000000,002,2,30#**

If the AVL received it successfully, it will send one SMS back to check it, then send you position message every 2 mins, 30 times.

【more information】 : X means Time interval (Unit: min)

It can be one of 0~999, X=0 means stop tracking;

Y can be one of 0~999, Y=0 means it will not stop tracking (until another stop

instruction)

2.3 View AVL trace on PC

2.3.1 Input position data to map software

1. Launch Internet Explorer on your computer. Other browsers may Also work, but Internet Explorer is recommended.
2. Download google-earth software from <http://earth.google.com/>
Type "http://maps.google.com" to connect to Google Map website for displaying the location map.
3. Put the longitude &latitude which you received from the SMS into the google earth map or <http://maps.google.com> .chick on search button, then you will find the position fixed. As the following picture shows.

【note】 :Please pay attention to change the position data format.

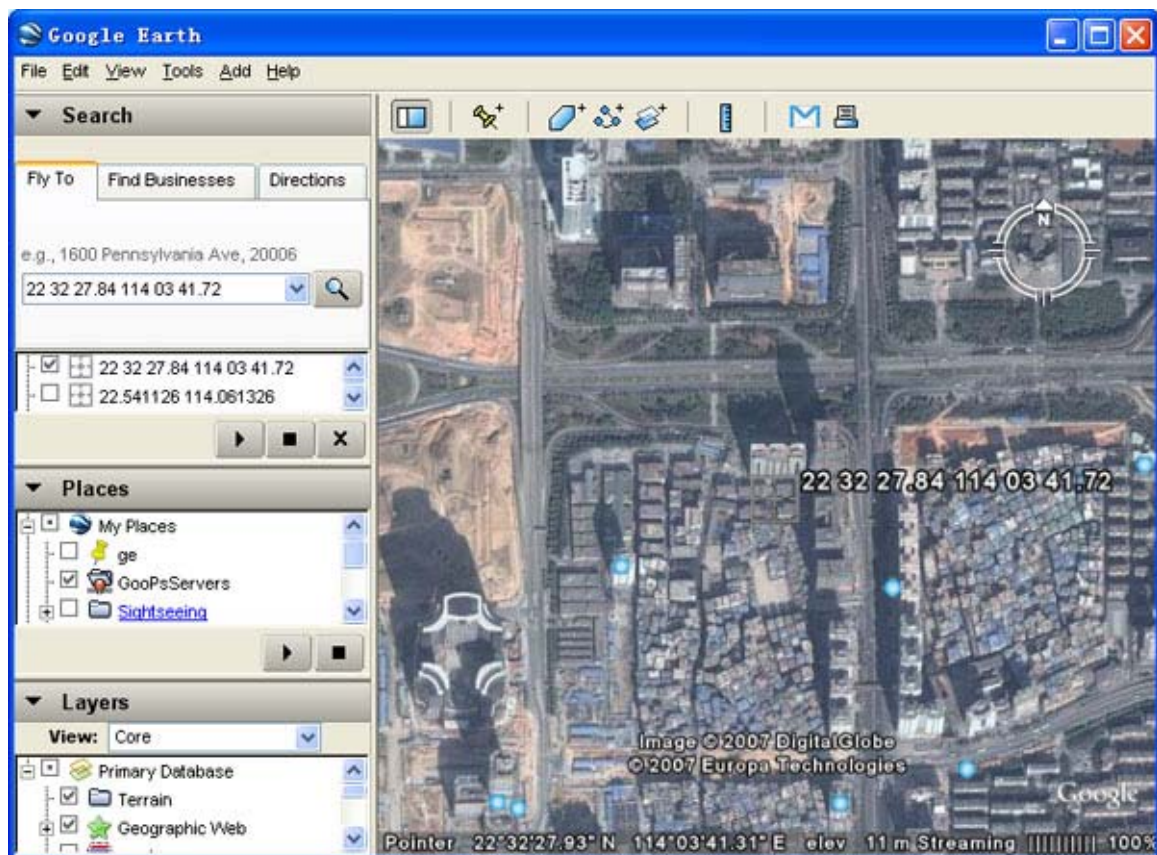

2.4 GPRS Setting Step by Step

This is a wonderful function, by virtue of GPRS, user can track the car, and view status of the car conveniently on PC. The GPRS ID of AVL03 , is use the IMEI number of GSM module. You can send sms command ***000000,801,0#** to AVL to check it.

【note】 : Please note that, in the bellow steps, **\$\$\$\$\$\$** is user password.

- Step1: Make sure that your SIM card in the AVL has GPRS function.
- Step2: Set APN

Every country has its APN, please refer to the attachment.

SMS format: ***\$\$\$\$\$,011,APN,Username,Password#**

For example: ***000000,011,cmnet,,#**

The user name and password can be null, “cmnet” is a Chinese`s APN.

After you send the SMS, it will send one SMS back to check it.

- Step3: Set IP Address & port number

By sending the SMS command, you can connect your AVL to Server by gprs.

SMS format: ***\$\$\$\$\$,015,IP,PORT#**

For example: ***000000,015,72.167.29.18,3303#**

72.167.29.18 is our company`s Server IP, and user also can link the AVL unit to his server, the IP and Port must be correct, then the unit can send out data to the Server via GPRS network.

- Step4 Set GPRS time interval

SMS format: ***\$\$\$\$\$,018,X,Y#**

X is the time interval, Y is the times of data has been sent.

For example: ***000000,018,300,0#**

This command is to set up the time interval is 5 mins and no times limit.

- Step5: Enable GPRS function

Send a SMS as following format.

SMS format: ***\$\$\$\$\$,016,X#**

For example: ***000000,016,1#**

X must be 1, meaning: Enabling GPRS function.

And, X is 0 means close GPRS function.

● **Step6: Receive alarm type information on Server**

The data received format in the Server is as below:

**\$\$ + L + ID + 0x9999 + 1B alarm types + GPRMC info + | + HDOP + | +
Status(5byte) + checksum(2byte) + \r\n**

GPRMC info is position data

1B Alarm types:

- =0x01 SOS button is pressed**
- =0x49 Button A is pressed**
- =0x08 The exterior power was cut off (5 minnites intervals)**
- =0x10 Low battery alarm**
- =0x30 Continuance trembling for 10S, after able to tremble alarm system**
- =0x40 over speed alarm**
- =0x41 not over speed alarm from over-speed state (in process)**
- =0x42 Geo- fence alarm**
- =0x43 Into fence from Geo-fence alarm (in process)**
- =0x50 I/O 1 close**
- =0x51 I/O 1 open**
- =0x52 I/O 2 close**
- =0x53 I/O 2 open**
- =0x54 I/O 3 close**
- =0x55 I/O 3 open**
- =0x56 I/O 4 close**
- =0x57 I/O 4 open**
- =0x88 heartbeat**
- =0x91 enter sleep mode**
- =0x92 exit sleep mode**
- =0x95 GPS Fix**

=0xAA Interval GPRS data

2.5 Common questions and solution

While you are operate your AVL, if you detect any question, please check if the following paragraph can help you.

■ **Q: You sent one SMS to the AVL, then if you receive one SMS, reading "Set error....." in a few mins. What happened?**

■ **A: your SMS command must have a format error, please check it:**

(1): Has your password been modified? And is the password right?

(2): W must be capital letter, and, if your password is initial, then, 0 is a number, not a letter.

(3): There is no space in the SMS, and you must check the symbol in the SMS.

■ **Q: When I call the AVL for a position, why is the AVL busy now?**

■ **A: (1) please check if GSM signal is in good state, Check if the green led is flashing. If the green led is growing periodically, not flash. That indicates the GSM signal is not in good state, you should wait for a minutes or remove it to anther position. If the green led is dark, the AVL must be in "sleep mode", please note (2).**

(2) If you find the there leds are dark at the same time, the AVL is in "sleep mode", you must wake it up, or you can turn off the "sleep mode" function. You can use "021"SMS command, please refer to the SMS instruction list. You can send: "***\$\$\$\$\$\$,021,00#**" to the AVL(***** is your password).

If the AVL send a successful SMS back, it indicates the AVL will never enter into sleep (until you change it).

(Unfinished, will be added!)

III. Attachment

3.1 SMS instruction list.

If you want to know more about the AVL, and design your special AVL, you can refer to the SMS instruction list.

\$\$\$\$\$\$ is user`s password , and initial password is 000000

	SMS Instruction	Format	Note
1	Request one position	*\$\$\$\$\$\$,000#	
2	Modify user password	*\$\$\$\$\$\$,001,@@@@@@#	\$\$\$\$\$\$ is old password @@@@@@ is new Password
3	Set the time intervals of position notice SMS The Position SMS will send to the preset SOS number.	*\$\$\$\$\$\$,002,X,Y#	X (Max 3 Digital) =0, Stop send position SMS =[1,999] Time interval (Unit: mins) Y (Max 3 Digital) =0,Continue send position SMS (Until stop it) =[1,999] After send Y times stop.
4	Set a preset phone & SMS number for SOS button	*\$\$\$\$\$\$,003,0,F,CallNumber, SMS Number#	F = 0, Disable this function =1, Only send an alarm SMS to the preset SMS Number Notice :Tel Number and SMS Number (must <25 digits)
5	Set low power alarm When the AVL voltage is lower than the preset value, AVL will send one lower power alarm GPRS data to the Preset Server.	*\$\$\$\$\$\$,004,X#	X (Voltage percent can be 10--99) For example =60 , 60%*4.2V, the present voltage is lower than 60%*4.2 V, send Alarm (the most voltage is 4.2 V)
6	Set over speed alarm	*\$\$\$\$\$\$,005,X,Y#	X (The speed preset value)

AVL03 User Guide

V3.23

	When the AVL speed higher than the preset value, AVL will send one over speed alarm GPRS data to the Preset Server.		= [10<XXX<250] unit is km/h When X <10, it Disable this function. Y=[10<Y<360] unit is second, the time interval to send speed alarm
7	Set Geo-fence alarm When the AVL move out preset scope, AVL will send one Geo-fence GPRS data to the Preset Server.	*\$\$\$\$\$\$,006,long1,lat1,long2,lat2,X,Y#	X=[10,360] is for time interval to send alarm, Y=0,Disable geo-fence alarm 1, into fence alarm. 2, out the fence alarm Long1>long2&lat1>lat2
8	Set APN,Username,Password	*\$\$\$\$\$\$,011,APN,Username,Password#	APN : APN string (Max 28 chars) User name: Your username (Max 28 chars) Password: Your password (Max 28 chars) * If haven't username or password, then left it blank. For example: *000000,011,CMNET,,# (It haven't username and password)
9	Set IP Address & port number	*\$\$\$\$\$\$,015,IP,PORT#	IP : xxx.xxx.xxx.xxx PORT : [1,65536]
10	Set the time intervals of GPRS Data	*\$\$\$\$\$\$,018,X,Y#	X (3 Digital) =0 stop send time interval GPRS =[10,999] Time interval (Unit: sec) Y (3 Digital) =0, Continue send GPRS Data (Until stop it) = [1,999] After send YYY times stop.
11	Enable/Disable GPRS function	*\$\$\$\$\$\$,016,X#	X=0 Disable GPRS unction X=1 Enable GPRS Function This is the last step of GPRS setting.

AVL03 User Guide V3.23

12	No action go into sleep mode waiting time	*\$\$\$\$\$,020,X#	When Device is no any action for X seconds(X = 20 - 65535 seconds),it will go to sleep mode.
13	Tremble sensor switch	*\$\$\$\$\$,021,XY#	X = 0 Disable Sleep mode X = 1 Enable Sleep mode Y = 0 Disable the tremble sensor Y = 1 Enable the tremble sensor
14	Send SMS When No GPRS	*\$\$\$\$\$,024,XXXXXXXXXX XXXXXXXXX#	X=0 Disable Send SMS When No GPRS Function X=1 Enable Send SMS When No GPRS Function X1 is for Heartbeat (88) X2 is for Low Battery (10) X3 is for Into Sleep (91) X4 is for Wakeup from sleep (92) X5 is for I/O Port 1 (50, 51) X6 is for I/O Port 2 (52, 53) X7 is for I/O Port 3 (54, 55) X8 is for I/O Port 4 (56, 57) X9 is SOS Key (01) X10 is for exterior power is cut off(08) X11 is for parking alarm(30) X12 is for GEO-fence alarm(42,43) X13 is for over speed alarm (40,41) X14 is for Button A alarm X15 is for GPRS fail for 3 times(GPRS error, FF+ location data) X16 is for time interval send SMS
15	Enable/Disable I/O port (For Out1/Out2/Cut Current)	*\$\$\$\$\$,025,X,Y#	X should be one of A,B and C. A is for Out A, B is for Out B, C is for Cut Current, Y can be 2 value: =1, cut off the oil by X. For Example:

AVL03 User Guide
V3.23

			<p>*000000,025,C,1# This instruction will change the Out A state to Enable, the voltage is low. =0 Resume the oil For Example: *000000,025,C,0#</p>
16	Heart Beat Switch	*\$\$\$\$\$\$,040,X#	<p>X=0 Disable the heart beat function X=1 Enable the heart beat function</p>
17	Heart Beat Intervals	*\$\$\$\$\$\$,041,X#	<p>X is the heart beat interval, unit is minute (1 < X < 9999)</p>
18	Heart Beat Init	*\$\$\$\$\$\$,042,0#	<p>When receive this command, the heart beat will re-count time</p>
19	Into sleep mode when without tremble for preset time	*\$\$\$\$\$\$,044,X#	<p>After the tremble sensor don't tremble for X second, tracker will into sleep mode 30 < X < 65536 (Unit : second) For Example, configure AVL into sleep mode after no tremble for 30 second: *000000,044,30#</p>
20	Wake up from Tremble	*\$\$\$\$\$\$,043,X#	<p>After the tremble sensor continuous tremble for X second, tracker will wake up 1 < X < 255 (Unit : second) AVL Wake up from sleep mode after no tremble for 10 second: *000000,044,10#</p>
21	Parking alarm	*\$\$\$\$\$\$,110,X#	<p>X=1 Enable Tremble alarm function, then if the AVL is Trembling for 10s continually, it will alarm(0x30), X=0 Disable Tremble alarm function</p>
22	Reading the IMEI number	*\$\$\$\$\$\$,801,0#	<p>This command to ask AVL</p>

AVL03 User Guide
V3.23

			reply the IMEI number
23	Initialization Tracker	*\$\$\$\$\$,990,099###	It will set all parameter to factory default value (Excluding the Password).
24	Initialization Password	*888888,999,666#	Send this command to AVL. It will reset the password to 000000.
25	Reboot by SMS command	*\$\$\$\$\$,009#	It will reboot the AVL by this sms command.
26	Extend setting	*\$\$\$\$\$,008,ABCDEFG#	<p>A=0, Disable position report function which get position SMS by Calling A=1, Enable position report function which get position SMS by Calling B=0, Send the SMS in Text format. B=1, Send the SMS in NMEA format. C=0, AVL do NOT hung up when one call incoming C=1, AVL hung up after 4~5 rings when call incoming D=0 E=0 F=0 G=0</p>

3.2 Update the firmware of the AVL

3.2.1 IAP Update User Guide

1) Install RS232 cable driver

A. At the first, Install the Driver for “USB Converter”



B. Connect the AVL unit to PC through RS232 cable, View the com port that the cable used

AVL03 User Guide

V3.23

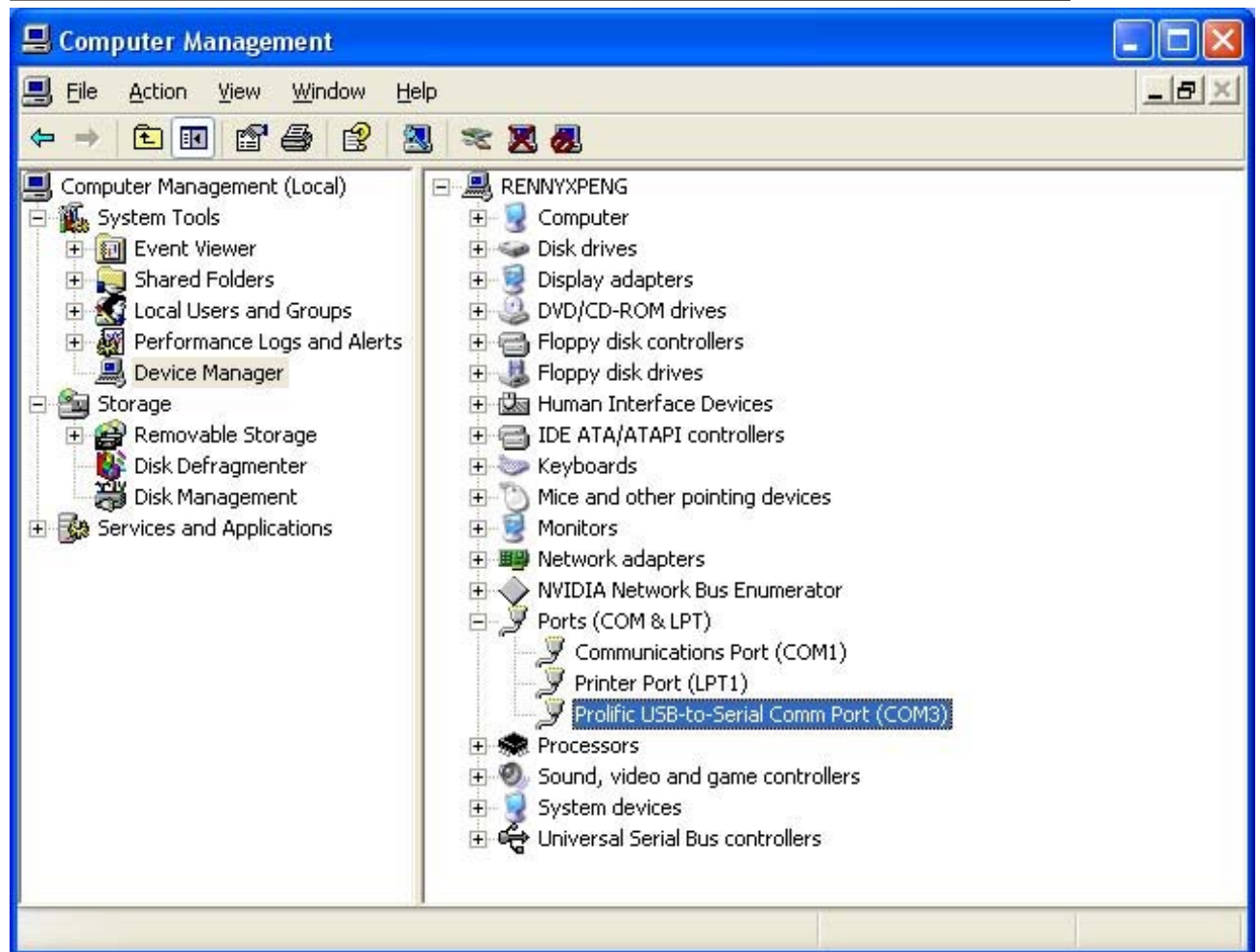

2) Turn on AVL device

3) Build a New Hyper terminal connect, fill the name, example as IAP_DL

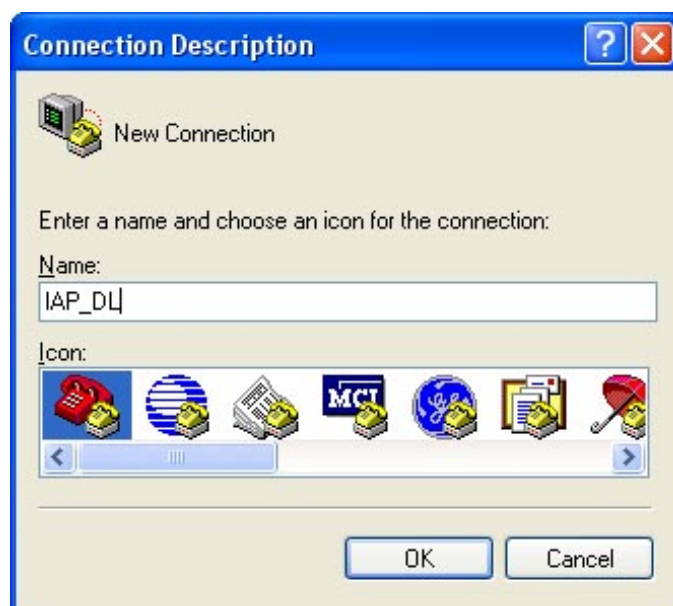

4) Choose the Com Port that the RS232 Cable used



Setup all the option like show in the picture follow

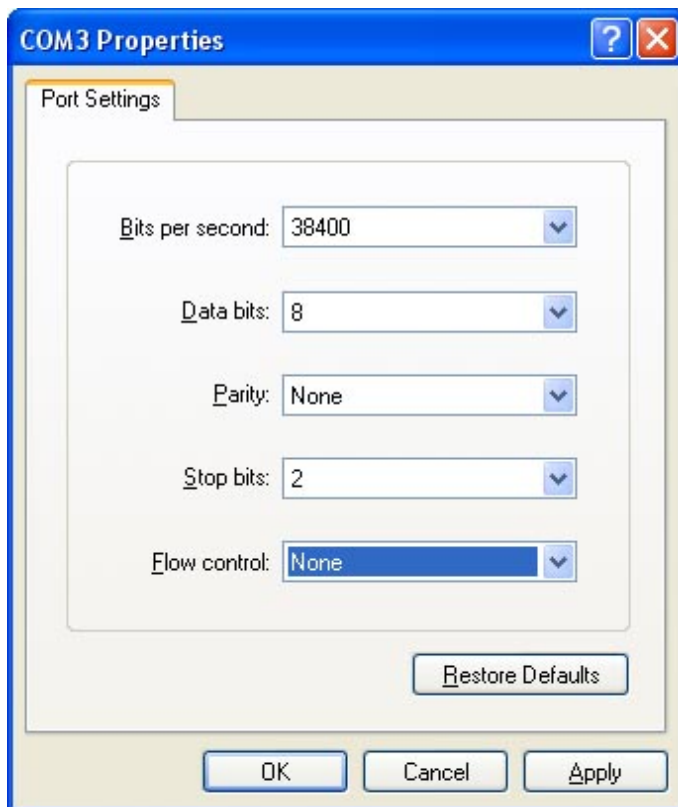

5) Into Configure Mode

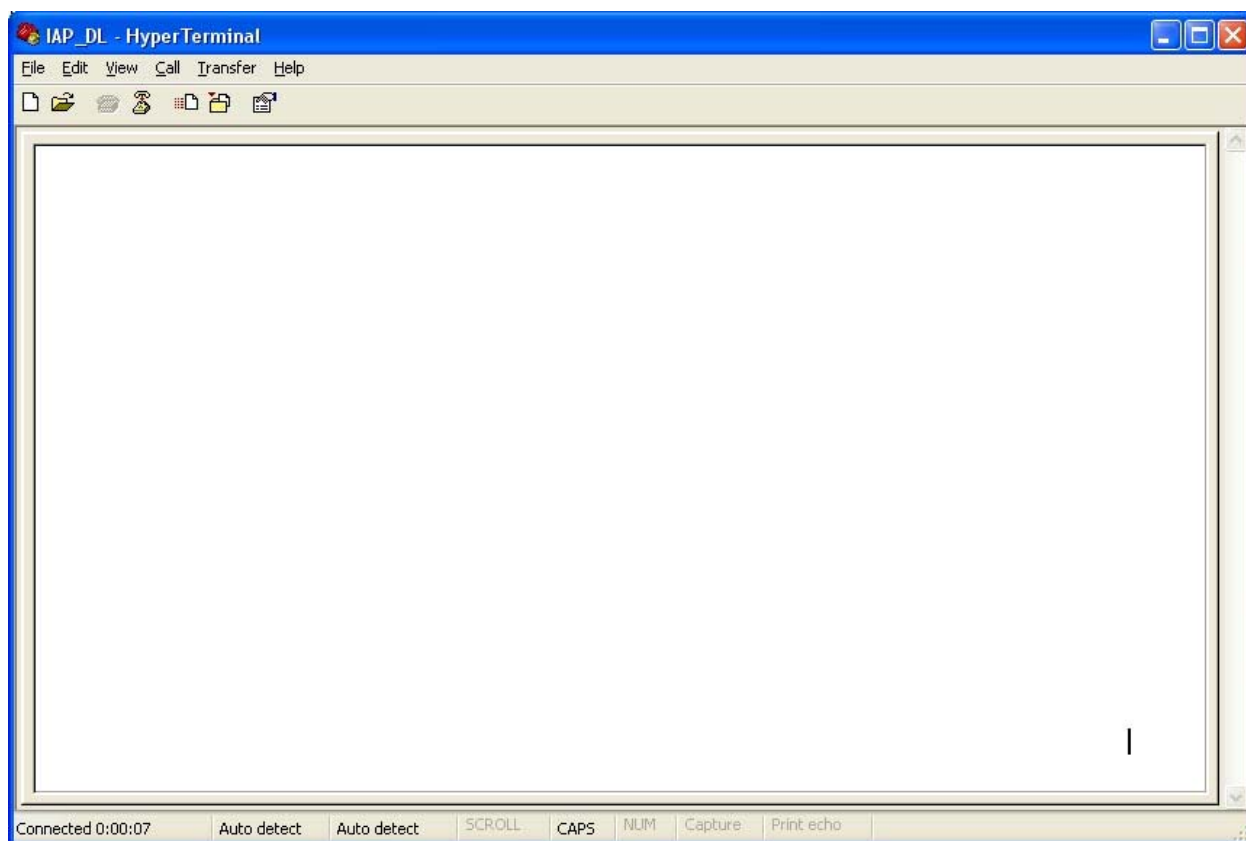

6) Turn Off AVL device

7) Press the Unit's SOS button and Turn on Power(Please hold it for several seconds), Unit's GSM/GPS/Sensors LED will still light at same time, Hyper terminal will display the interface like the picture follow. Then choose Send file (Send-> Send File)

AVL03 User Guide

V3.23

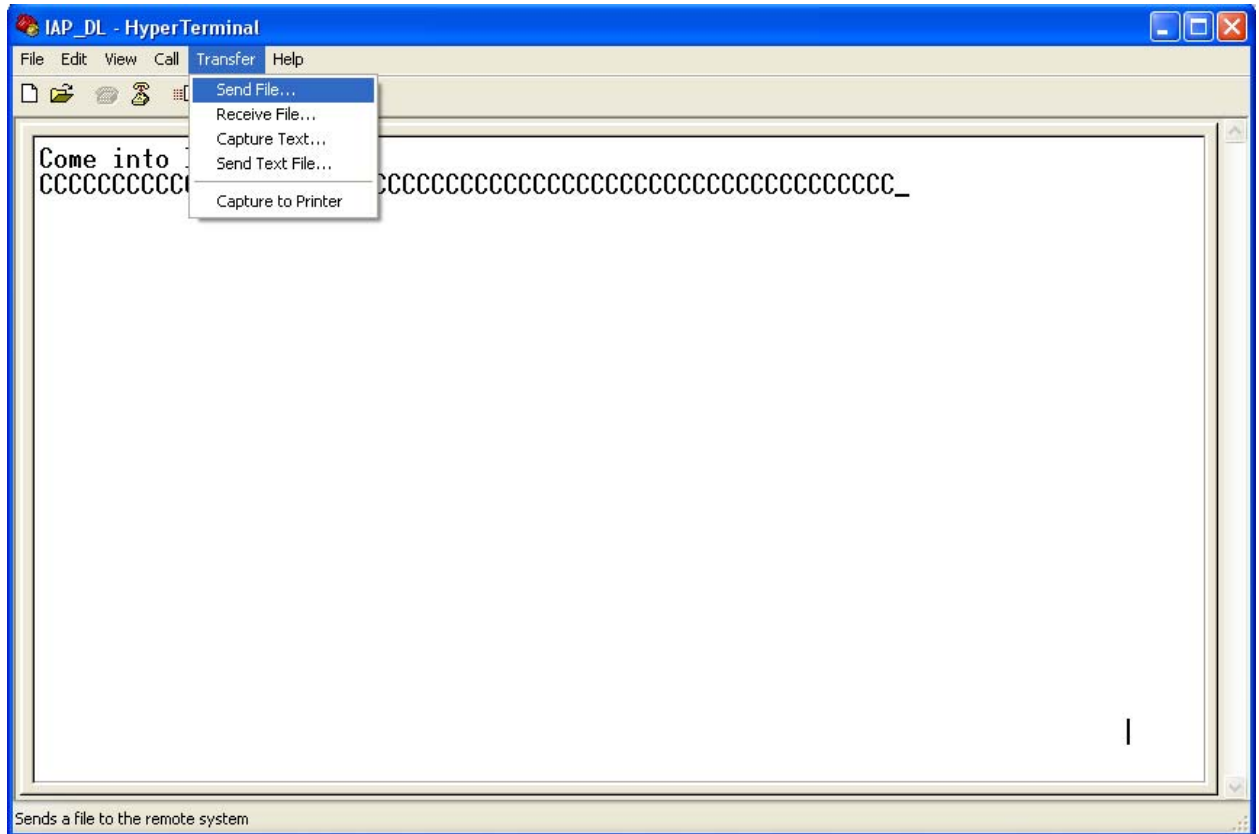

Choose the firmware that you want to Update;
Protocol Choose: Xmodem

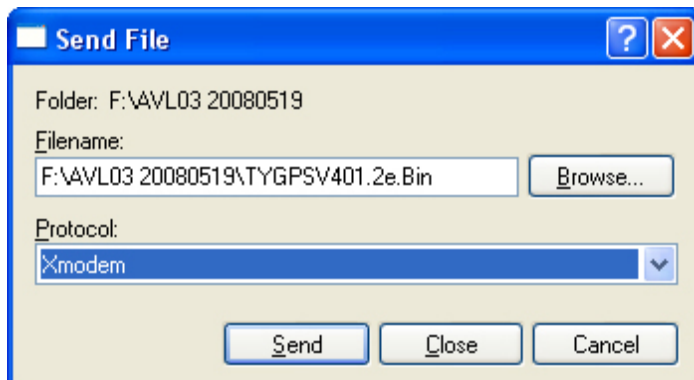

Press Send button, Will display a New Windows that show the update process.

AVL03 User Guide

V3.23

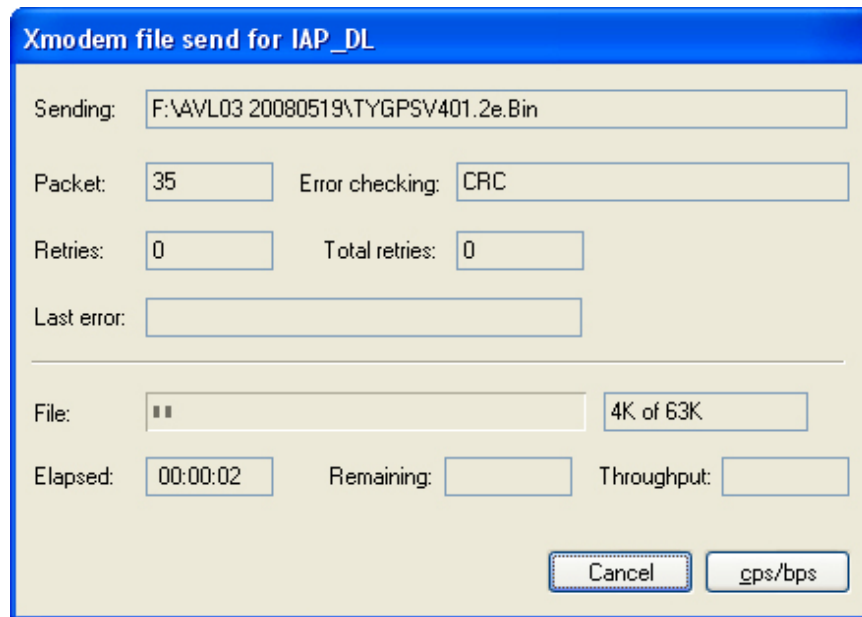

(6) When finish Update, Tracker will reboot automatically, and the GSM/GPS/Sensors light will blink quickly. After about 3-5 mins, this interface will shut by itself. **When the update is pressing, all indicator will off for 10 seconds, doesn't turn off power of AVL03, otherwise will cause MCU broken.**

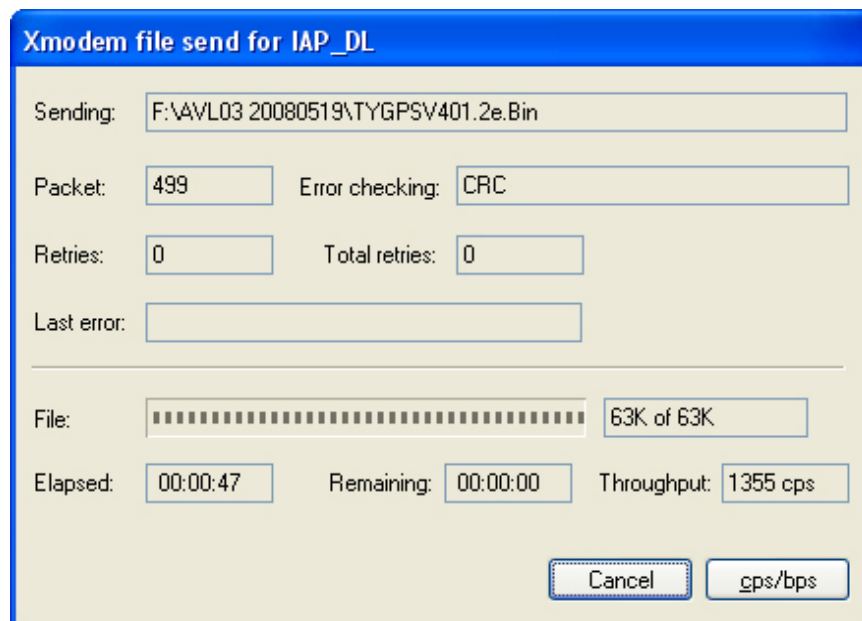

(7) When the AVL03 LED is blinking back to normal mode. Turn Off and Turn On Tracker again. The Firmware updates finish.

3.3 Worldwide APN (Access Point Name) List

Country	Mobile operator	Access point name
Argentina	Personal	gprs.personal.com
Argentina	Unifon	internet.gprs.unifon.com.ar
Australia	Telstra	telstra.internet
Australia	Optus	internet
Australia	Three	3netaccess
Australia	Vodafone	internet
Austria	Max Online	gprsinternet
Austria	One	wap.one.at
Belgium	Orange	orangeinternet
Belgium	Mobistar	web.pro.be
Belgium	Proximus	internet.proximus.be
Bermuda	AT&T	proxy
Bermuda	Mobility	net.bm
Brazil	Claro	claro.com.br
Brazil	Oi	gprs.oi.com.br
Brazil	TIM	tim.br
Bulgaria	Mobitel (Mtel)	inet-gprs.mtel.bg
Canada	Fido	internet.fido.ca
Canada	Rogers AT&T	internet.com
Chile	Entel PCS	imovil.entelpcs.cl bam.entelpcs.cl
Chile	Telefonica GSM	web.tnovil.cl
China	China Mobile	cmnet
Croatia	VIPNET	gprs.vipnet.hr
Czech Republic	Eurotel	internet
Czech Republic	Oskar	internet
Czech Republic	Oskar prepaid cards	ointernet
Czech Republic	T-Mobile	internet.t-mobile.cz

AVL03 User Guide

V3.23

Denmark	TDCmobil	internet
Denmark	Orange	web.orange.dk
Egypt	Vodafone	internet.vodafone.net
Dominican Republic	Orange Dominicana	orangenet.com.do
Finland	Telia Mobile	internet
Finland	DNA	internet
Finland	Sonera	internet
Finland	Radiolinja	internet
Finland	Saunalahti	saunalahti
France	Orange	orange.fr
France	SFR	websfr
France	Bouygues Telecom	eBouygTel.com
Germany	D2 Vodafone	web.vodafone.de
Germany	E-Plus	internet.eplus.de
Germany	O2	internet
Germany	Quam	quam.de
Germany	T-Mobile D1	internet.t-d1.de
Greece	Vodafone	internet.vodafone.gr
Greece	Teletet	gint.b-online.gr
Greece	Cosmote	internet
Hungary	Vodafone (Prepaid "Optimized")	vitamax.internet.vodafone.net
Hungary	Vodafone (Prepaid "Standard")	vitamax.snet.vodafone.net
Hungary	Vodafone (Postpaid "Optimized")	internet.vodafone.net
Hungary	Vodafone (Postpaid "Standard")	standardnet.vodafone.net
Hong Kong	CSL	internet
Hong Kong	Orange	web.orangehk.com
Hong Kong	New World	internet
Hong Kong	People	internet
Hong Kong	SmarTone	internet

AVL03 User Guide

V3.23

Hong Kong	Sunday	internet
India	Orange, Hutch	www
Iceland	Siminn	gprs.simi.is
India	BPL Mobile	bplgprs.com
India	Airtel	airtelgprs.com
Indonesia	Telkomsel	internet
Ireland	O2	internet
Ireland	Vodafone	live.vodafone.com
Israel	Cellcom	internetg
Israel	Orange	internet
Italy	TIM	uni.tim.it ibox.tim.it
Italy	Vodafone Omnitel	web.omnitel.it
Italy	Wind	internet.wind
Latvia	Latvia Mobile Telefone	internet.lmt.lv
Luxembourg	LUXGSM	web.pt.lu
Luxembourg	Tango	internet
Malaysia	Celcom	celcom.net.my
Mexico	Movistar	internet.movistar.mx
Mexico	Telcel	internet.itelcel.com
Montenegro	Monet	gprs.monetcg.com
Netherlands	T-Mobile	internet
Netherlands	KPM Mobile	internet
Netherlands	Orange	internet
Netherlands	O2	internet
Netherlands	Vodafone (normal)	web.vodafone.nl
Netherlands	Vodafone (business)	office.vodafone.nl
New Zealand	Vodafone NZ	www.vodafone.net.nz
Norway	Netcom	internet.netcom.no

AVL03 User Guide

V3.23

Norway	Telenor	internet
Pakistan	UFone	ufone.internet
Paraguay	Personal	internet
Paraguay	Tigo	internet.tigo.py
Philippines	Smart	internet
Philippines	Globe	internet.globe.com.ph
Poland	Era	erainternet
Poland	Idea	www.idea.pl
Poland	PlusGSM	www.plusgsm.pl
Portugal	Optimus	internet
Portugal	TMN	internet
Portugal	Vodafone (Telcel)	internet.vodafone.pt
Romania	Connex	internet.connex.ro
Romania	Orange	internet
Russia	BeeLine	internet.beeline.ru
Russia	Megafon	internet.nw
Russia	MTS	internet.mts.ru
Russia	PrimTel	internet.printel.ru
Saudi Arabia	Saudi Telecom	Jawalnet.com.sa
Serbia-Montenegro	Mobtel Srbija	internet
Serbia-Montenegro	Telekom Srbija	gprsinternet
Singapore	M1	sunsurf
Singapore	Singtel	internet
Singapore	Starhub	shwapint
Slovakia	Eurotel	internet
Slovakia	Orange	internet
South Africa	MTN	internet
Spain	Amena	amenawap

AVL03 User Guide

V3.23

Spain	Telefonica (Movistar)	movistar.es
Spain	Vodafone	airtelnet
Sweden	Telia	online.telia.se
Sweden	Vodafone SE	internet.vodafone.net
Switzerland	Swisscom	gprs.swisscom.ch
Switzerland	Orange CH	internet
Switzerland	sunrise	internet
Switzerland	UMC	www.umc.ua
Taiwan	Chunghwa Telecom	internet
Taiwan	Far EasTone	fetnet01
Taiwan	KG Telecom	internet
Taiwan	Taiwan Cellular	internet
Thailand	AIS	internet
Thailand	DTAC	www.dtac.co.th
Turkey	Avea	internet
Turkey	Aycell	aycell
Turkey	Telsim	telsim
Turkey	Turkcell	internet
UK	Jersey Telecom	pepper
UK	O2	mobile.o2.co.uk
UK	T-Mobile	general.t-mobile.co.uk
UK	Vodafone UK	internet
UK	Orange	orangeinternet
Ukraine	Kyivstar GSM	www.kyivstar.net
Ukraine	UMC	www.umc.ua
USA	T-Mobile	internet2.voicestream.com
USA	AT&T	proxy
USA	Cingular	isp.cingular
Venezuela	Digital TIM	gprsweb.digitel.ve