

BOXFINDER terminals

User's Manual



firmware 0001

Quality

Reliability

Simplicity



BOXFINDER (0001) User's Manual

Contents

Introduction.....	4
1. Package.....	6
2. Technical specifications.....	6
3. Safe operating rules.....	7
4. Contacts description.....	7
5. Algorithm of Terminal's operating.....	9
6. Acoustic search.....	9
7. Connecting.....	10
7.1. Inserting SIM-card.....	10
7.2. LED indication work.....	10
8. Description of Terminal units' operating.....	10
8.1. Description of universal input operation in analog mode.....	10
8.1.1. Mean value and discrete event generation.....	11
8.1.2. Frequency count.....	11
8.2. Determination of strike.....	11
8.3. Transmitting monitoring data.....	12
8.4. Remote configuration.....	12
9. Connecting external peripheral.....	13
9.1. Connecting 1Wire sensors.....	13
9.1.1. Connecting iButton (DS1990, DS1982)identification key.....	13
10. Configurator.....	14
10.1. Program installation and running.....	14
10.2. Device tab.....	15
10.3. Troubleshooting tab.....	17
10.4. Command mode tab.....	20
10.5. Graphic interface settings.....	22
10.5.1. Security.....	22
10.5.2. Data transmission.....	22
10.5.3. Protocol.....	23
10.5.4. Power saving.....	23
10.5.5. Inputs/outputs.....	24
10.5.6. Digital inputs.....	24
10.5.7. Sound.....	25
10.6. Data loading and sending to server.....	26
10.6.1. Data loading from the Terminal to file.....	26
10.6.2. Sending data to server.....	26
11. Commands list.....	27
11.1. Setting for SMS control.....	27
11.2. Data transmission settings.....	27
11.3. Server exchange protocol settings.....	29

BOXFINDER (0001) User's Manual

11.4. Information commands	31
11.5. Service commands	33
11.6. Voice communication settings.....	34
11.7. Universal input setting.....	35
11.8. Relay setting.....	35
12. GALILEOSKY protocol parameters	36
13. Bootloader	37
13.1. USB channel download	37
13.2. GPRS channel download	37
13.3. Using universal input to enter bootloader mode	37
13.4. LED operation during reflashing	37
14. Additional information	38

Introduction

RSA "GALILEOSKY", LLC. produces GALILEOSKY terminals for GPS and GLONASS real time vehicles monitoring. The Terminals determine the mobile object location recording the time and route as points with geographical coordinates and send the data to the server to be further processed and sent to the traffic controller panel.

In addition, a number of other vehicle parameters are recorded: the state of analog and discrete inputs of the Terminal and the state of digital interfaces.

The Terminals can be used in any vehicle.

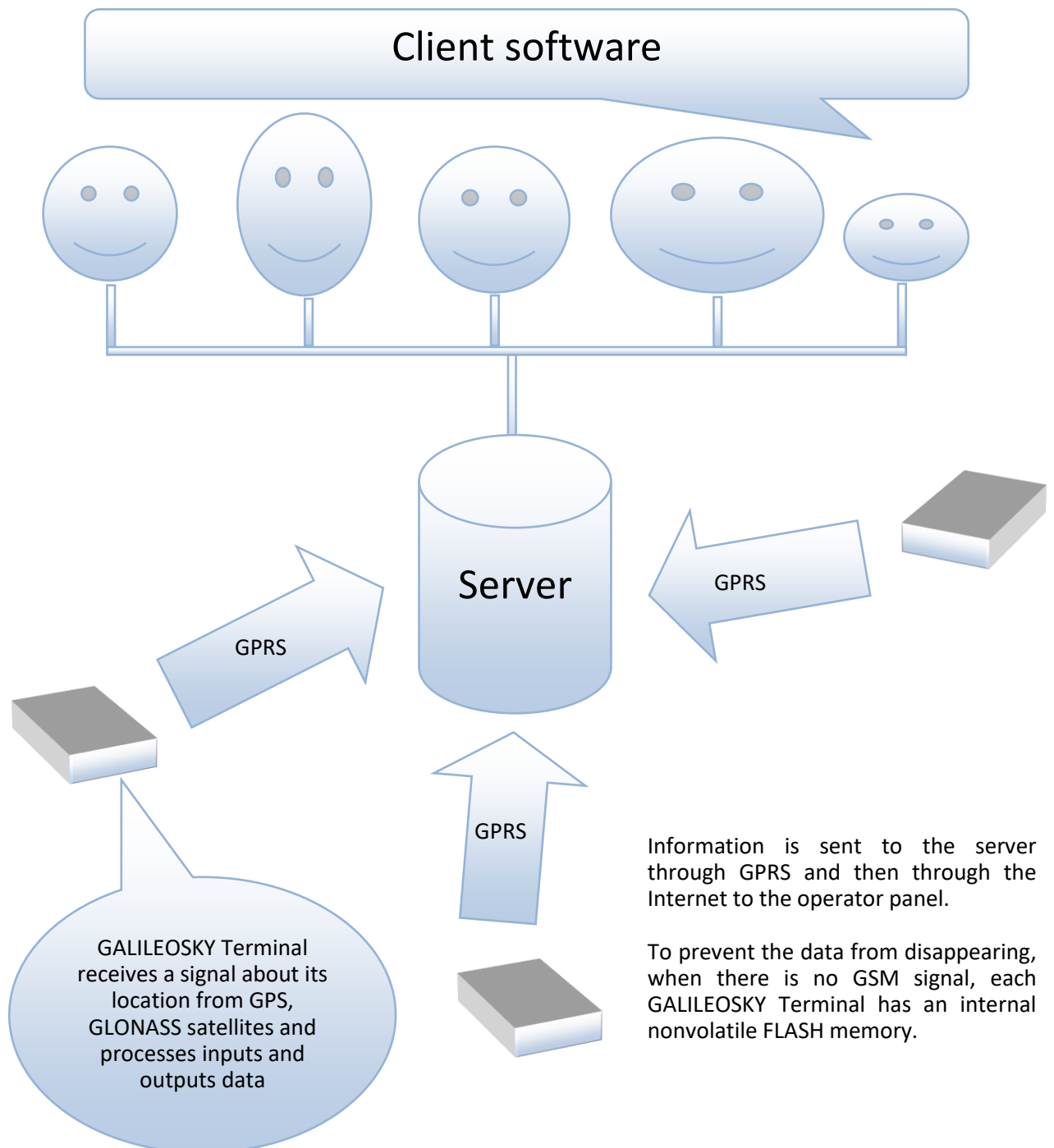

BOXFINDER (0001) User's Manual

The terminal provides the following opportunities:

- ✓ Vehicles and cargoes monitoring;
- ✓ Voice communication with the traffic dispatcher;
- ✓ GSM enabled remote software update;
- ✓ Continuous troubleshooting of the Terminal through the USB port;
- ✓ Car alarm and remote engine start;
- ✓ Securing stationary objects;
- ✓ Setting the Terminal through SMS, GPRS, USB;
- ✓ and others (see sections [Terminal units' operating](#) and [Connecting external peripheral](#)).

The information sent by the terminal includes:

- ✓ The exact Greenwich time and date;
- ✓ Vehicle coordinates: latitude, longitude, height;
- ✓ Vehicles speed and direction;
- ✓ Inputs (buttons) and analog sensors state;
- ✓ External digital sensors state;
- ✓ and others (see details of transmitted data in section [Server exchange protocol](#))

In addition, the company provides warranty service and technical support on its site <http://7gis.ru> and forum <http://forum.7gis.ru>.

Before starting the work study the instruction carefully.

1. Package

The standard package includes BOXFINDER terminal (hereinafter referred to as the Terminal) and a cable assembly. Everything extra should be bought separately.

You will also need:

1. Cable Mini USB B – USB A	1
-----------------------------	---

2. Technical specifications

Parameter	BOXFINDER GSM
GLONASS/GSM receiver	Sensitivity: -165dBm Cold start 35s Hot start 1s
Coordinates determination accuracy, 95% of time, not worse	5 m
GSM modem	GSM 900/1800, GPRS class 10
GLONASS aerial	In-built
GSM aerial	In-built
SIM-card Format	micro-SIM
In-built microphone	yes
In-built bistable relay	maximum switching power: 60 W; maximum switching DC voltage: 220 V; maximum switching AC voltage: 250 V.
Universal input	Analog-discrete and pulse frequency mode: - voltage interval – 0-33 V; - maximum measured frequency – 4 khz; - input resistance 5,5 kOhm to the ground. Digital mode: - 1-Wire.
1-Wire	yes
USB 2.0	Terminal setting, troubleshooting and reflashing
ADC resolution in bits	12
Accelerometer	In-built
Tamper sensor	yes
Internal battery	14 ah
Archive capacity	150000 points
Transmission protocol	GALILEOSKY; adjustable length-tagged
Enclosure protection	IP65
Operating temperature range	-40...+85 °C
Service life	About 10 years, sending one point 2 times a day
Dimensions	125,0 mm x 102,0 mm x 42,0 mm
Weight	within 350 r
Body material	plastic

Warranty	2 years since the purchase date
Average service life	10 years

3. Safe operating rules

Before using the Terminal study the instructions of GSM/GPRS devices safe operating.

Attention! To avoid failure:

- **Make sure the contacts are connected correctly!**
- **Unused contacts must be well insulated!**

4. Contacts description

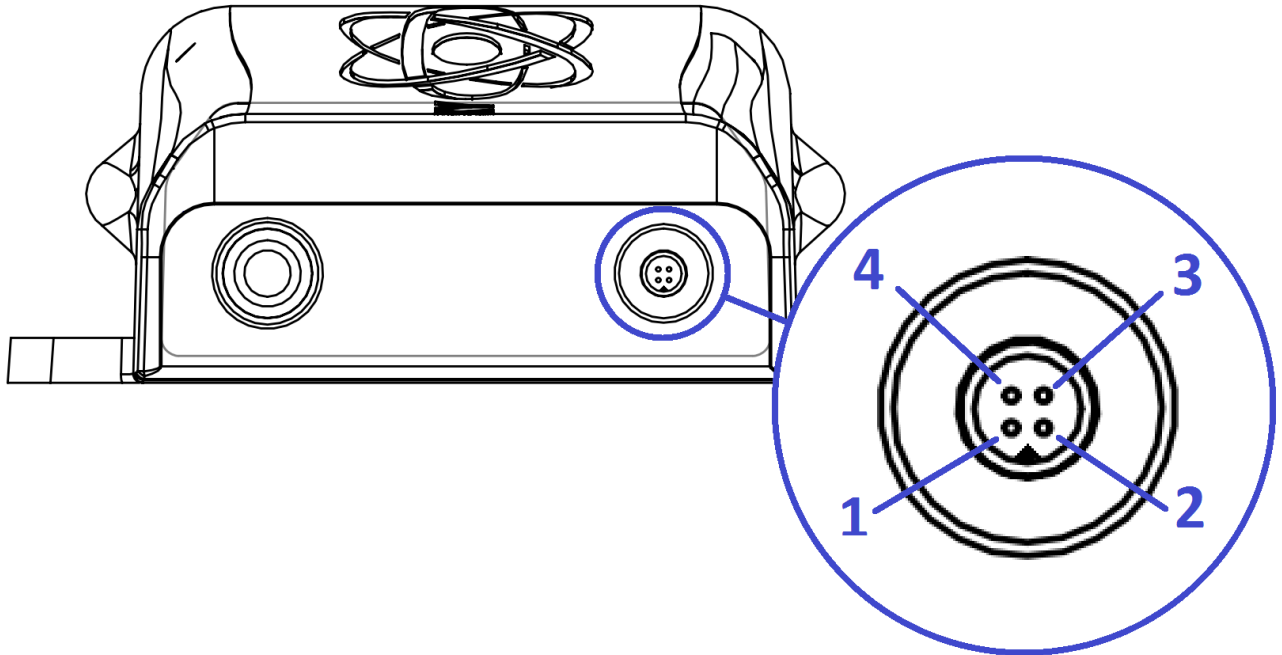

No	Contact	Description
1	R1	First relay contact
2	GND	Ground 1-Wire
3	IN	Universal input
4	R2	Second relay contact

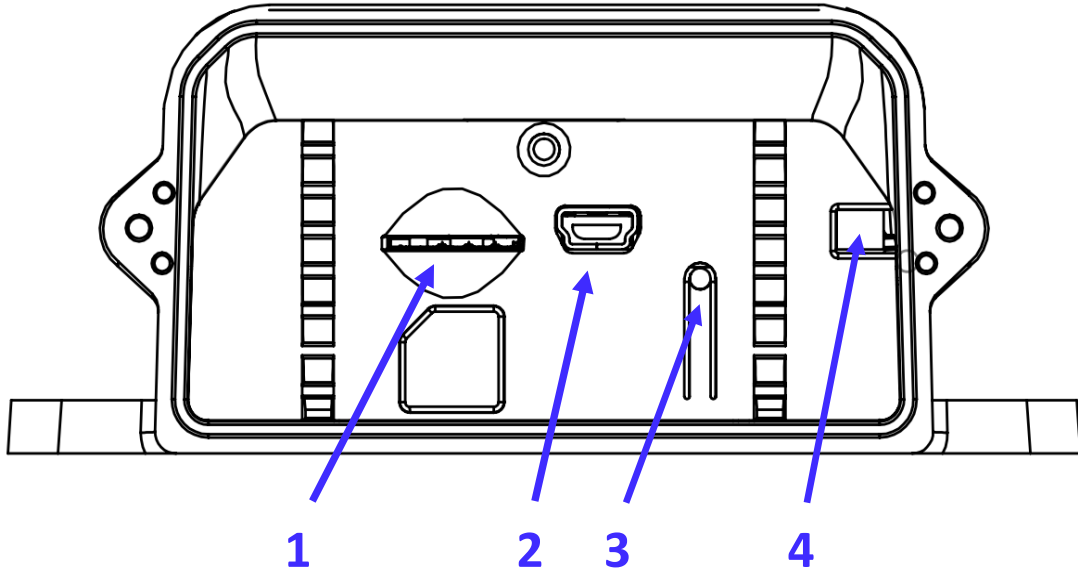

1. MicroSIM-card adapter.
2. Mini USB B adapter.
3. Opening sensor.
4. Connecting battery adapter.

5. Algorithm of Terminal's operating

Terminal has 2 operating modes:

1. Operating mode. Sensors' scanning, coordinates determination, sending data to server, phone calls and sending SMS are carried out in this mode.
2. Sleepmode. Terminal switches off all internal modules and does not perform any actions in this mode.

After sensors' scanning, coordinates determination and sending data to server in operating mode, Terminal automatically switches to sleepmode.

Terminal can leave sleepmode in the following cases:

1. Finishing sleep time assigned in the settings.
2. Activating opening body sensor.
3. Determination of strike by accelerometer.
4. Activating on analog input. Activating zone is applied by command incfg0 (See section [Universal input setting](#)).

6. Acoustic search

Terminal has a microphone. While having a phone call you may hear some noise around the terminal. You can use this function to find the terminal, by producing loud sounds (e.g. honk) and evaluating their gain and damping.

7. Connecting

7.1. Inserting SIM-card

Use a SIM-card with activated GPRS and SMS services.
Insert the card carefully **without applying excessive force**.
To eject SIM-card, press it.

7.2. LED indication work

Blinking frequency, times	Description
3	GSM-module is switched on
2	GLONASS-module is switched on
1	GLONASS and GSM-modules are switched off, Terminal is in operating mode.

8. Description of Terminal units' operating

8.1. Description of universal input operation in analog mode

To attach external sensors, the terminal has a universal input, which, in accordance with settings, can be analog-frequency input or interface 1-Wire. Input function is set in Terminal settings (see section [Inputs/outputs](#)). In section [Contacts description](#) input is set as IN.

Input specifications in analog mode:

Feature	Value
Maximum measured voltage	33 V
ADC resolution	12 bit
Maximum transmitted signal frequency	4 kHz

In analog mode input has the following settings:

Parameter	Explanation
Filter type (input function)	0 - arithmetical average (also discrete input state is generated); 2 – frequency input.
Filter length to calculate the mean value	The greater this parameter, the more slowly the device responds to the input signal change. With filter length equal to 1 - averaging does not happen. It is necessary to set this parameter in 1 for frequency inputs.
Ranges for response/ nonresponse areas (logical 1 and 0)	To process discrete signals, it is needed to set ranges, where signal is equal to one and zero. Discrete input statuses should be seen in the Status of Inputs field, but not in the Input voltage. While counting pulses or frequency, it is necessary to put the value equal to half the pulse value into all the fields of the given group. (example: the pulses' amplitude is 5000 mV, so all the fields must take the value 2500 mV).

8.1.1. Mean value and discrete event generation

Let us consider the example with the following input settings (see left-hand figure):
 Filter type is 0;
 Filter length is 5;
 Logical one zone range is 8-33V;
 Logical zero zone range is 0-3V.

The mean value is calculated continuously and is put into the corresponding field IN. At the same time, it is continuously checked whether the calculated value belongs to the logical zero and logical one range. If it is in the range 8-33V, the corresponding bit will find itself in the Status of Inputs field and a point will be recorded. At value coming into the indifference zone (3V-8V), the former bit value will be saved to the Status of Inputs field. If the value is in the logical zero zone (0V-3V), the corresponding bit in the Status of Inputs field is set to zero. Thus, we can see that the given bit changes its state only in response or nonresponse signal zones.

Example 2 (right-hand figure). In contrast to example 1, response and nonresponse zones have changed places.

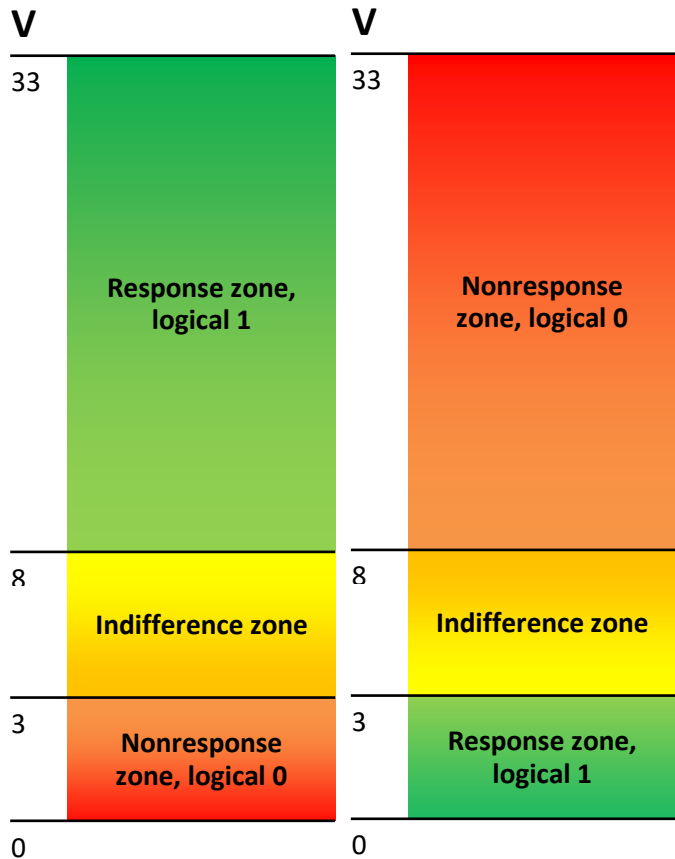

8.1.2. Frequency count

To measure frequency in some sensors it is needed to pull frequency output from the sensor to plus sensor supply with 1kOhm resistor. Otherwise, frequency count will be impossible.

8.2. Determination of strike

All devices can determine the Terminal's strike, and at that moment the Terminal leaves sleepmode. Strike is exceedance of set acceleration limit on any accelerometer axis.

8.3. *Transmitting monitoring data*

Terminal allows specifying the list of preferred GSM-networks. The main priority is given to networks from the beginning of the list. Every network is specified with country's code and operator's code. Terminal supports up to 30 networks (OPSO command, section "[Data transmission settings](#)"). If it is impossible to connect to one of the preferred GSM-networks, the Terminal connects to any network but does not establish connection to the server, thus voice communication and SMS will be available according to a tariff of the installed SIM-card.

The Terminal allows data transmission to the main and backup monitoring server. The Terminal accounts transmitted data separately for each server, thus both will receive full archive with the track.

Transmitted data may be coded; XTEA3 algorithm (<http://tomstdenis.tripod.com/xtea.pdf>) is used for coding. Commands and responses to them are not coded.

8.4. *Remote configuration*

Remote configuration can be performed through several data transfer channels:

1. SMS. The Terminal has a list of 4 authorized phone numbers, the messages from which are treated as configuration commands. The available commands are described in the section "[Settings for SMS control](#)". A phone number can be added to the list of authorized numbers either in the Configurator, or by sending a message with "AddPhone" command (section "[Settings for SMS control](#)").
2. GPRS. Commands can be sent from the monitoring data processing server. The format of the commands is described in the section "[Server exchange protocol settings](#)".
3. GPRS. Sending commands via Configurator and remote configuration server of RSA "GALILEOSKY", LLC. In this case, the Terminal supports two parallel connections: the first – with the monitoring data processing server, and the second – with the remote configuration server. Remote configuration can be enabled using RemoteConfig 1 command (section "[Service commands](#)"). It is possible to send commands to the Terminal, to receive current information from connected sensors and to receive troubleshooting messages, when working with the remote configuration server. Using the Configurator, it is possible to create a command pack to configure the Terminal and to save it on the server. These commands will be sent to the Terminal when it establishes the connection to the server.

9. Connecting external peripheral

9.1. Connecting 1Wire sensors

It is possible to connect different 1-Wire interface sensors. They can work simultaneously. To work with 1-Wire interface, universal input should be set-up for "1-Wire" mode.

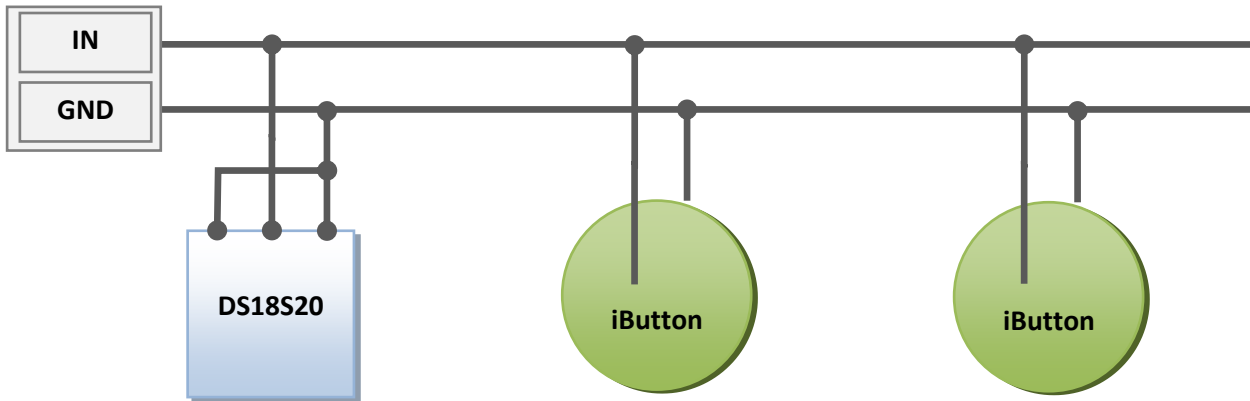

9.1.1. Connecting iButton (DS1990, DS1982) identification key

There are several identification key applications:

- driver identification;
- trailer detachment identification.

In the same way, it is possible to connect devices emulating iButton, for example, RFID-codes readers.

The Terminal can support up to 8 identification keys with certain identifiers or two identification keys with any identifier.

When using a microSD card, up to 1000 IK with certain identifier are supported.

By identification key applying to IN and GND contacts ("[Contacts description](#)") the key number is entered into the memory and four lower bytes are sent to the server without checksum. By key disconnection the number turns to zero.

Eight key identifiers can be set using iButtons command (section "[Digital inputs](#)") or in the Configurator on "Settings\Digital inputs tab". You should enter 4 lower bytes of iButton key number without checksum, in hexadecimal system.

For example, full key hexadecimal number:

09 91 02 0C 00 00 00 5C, where

09 – type of device (in this case, it is DS1982, for DS1990 – 01),

91 02 0C 00 00 00– unique number,

5C – the checksum.

In this case, 91 02 0C 00 must be entered.

By identification key applying with one of the certain identifiers, a correspondent bit will be set in iButton connection status field. You may control it on the "Device" tab in the Configurator. Checking 1-Wire bus is carried out only once while leaving the "sleepmode" by the Terminal.

10. Configurator

Configurator is a PC program, which allows:

- configuring the Terminal via graphic interface and with the help of commands;
- troubleshooting the Terminal with saving the results in a log-file;
- seeing the Terminal units state in real time mode;
- downloading monitoring data from the internal memory;
- sending the downloaded data to the server;

32 and 64 bit OS are supported: Windows 7, Windows 8.

10.1. Program installation and running

Download the Configurator program from the site <http://7gis.ru/en/podderzhka/programmyi.html> and launch it.

Attention! Program installation may require changes of crucial OS elements. Do not let your antivirus program block the installer operation.

In case of a security system warning, confirm launching the program.

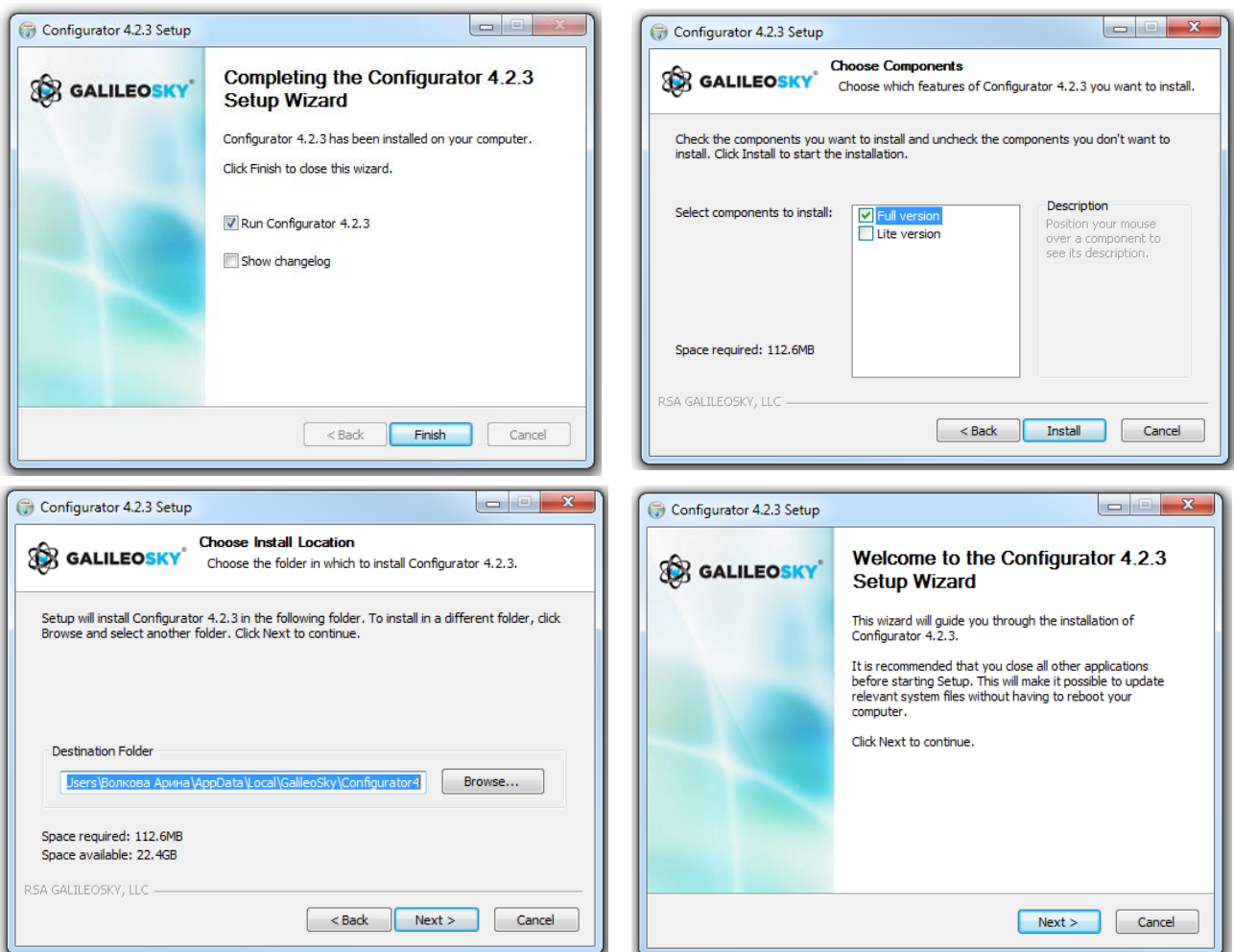

During the installation of the Configurator old drivers will be deleted and new ones will be installed. It is possible to install the major version of the Configurator or a limited one. The latter one allows uploading archive and receiving the current parameters of sensors, but not changing the settings.

Start the Configurator program (from Start menu\Programs\GALILEOSKY\Configurator). Turn on the power of the Terminal and connect it to the computer via a USB cable.

After the Terminal connection, the program loads all the Terminal's settings parameters automatically. If the program identifies the Terminal, all the buttons on the vertical left-hand panel will be active.

10.2. Device tab

The tab displays information about the Terminal state and allows its resetting. Parameter values, which are beyond the limits, wrong coordinates and responses on inputs are shown in red.

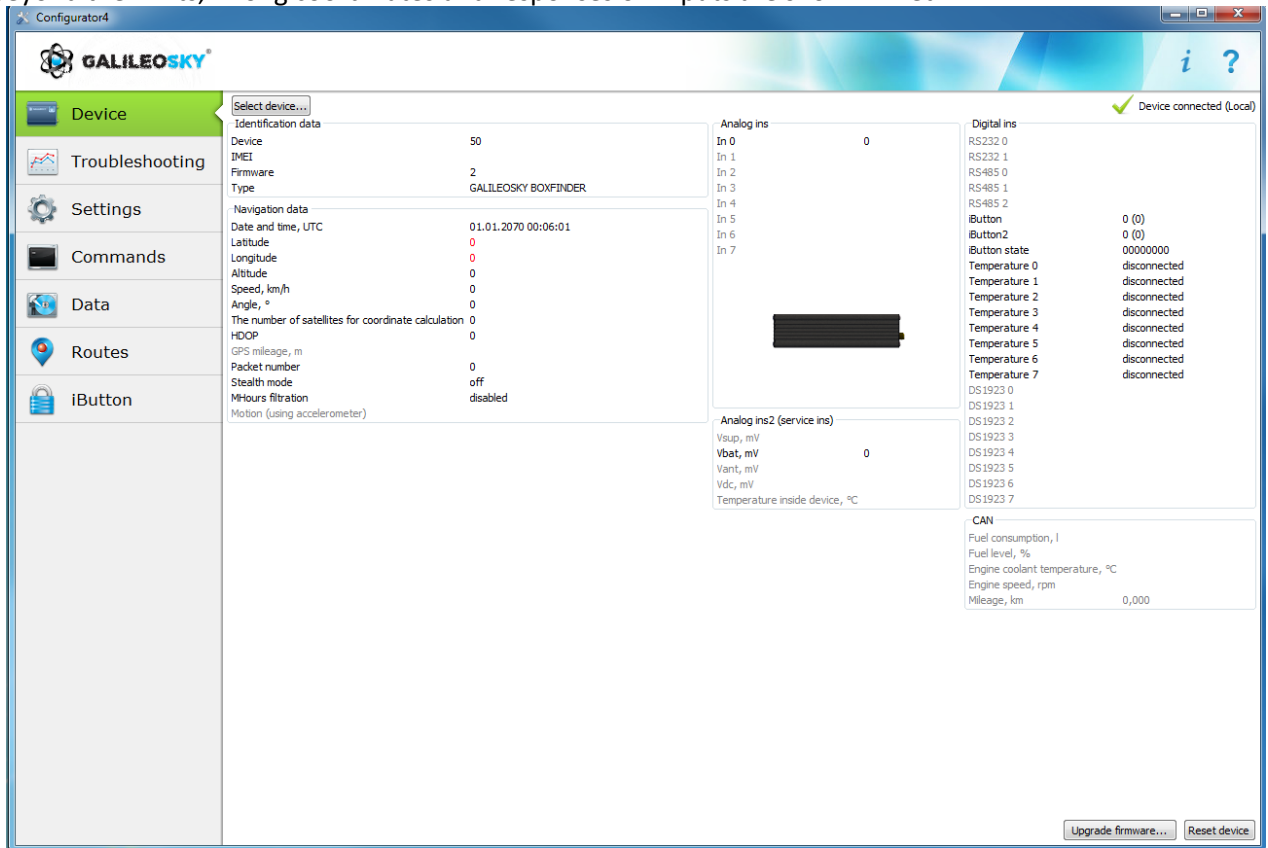

If there is a PIN code in the Terminal, the program will request it to access the settings. By wrong code entering the Terminal will disconnect from the computer, reset, connect to the Configurator again and wait for the right code enter.

For remote configuration and troubleshooting of the Terminal, click "Select device..." button. In the appeared window, enter your login and password to get the access to the remote configuration server. You can get the login and the password in RSA "GALILEOSKY", LLC. department of technical support or by clicking the "Register new user" button.

BOXFINDER (0001) User's Manual

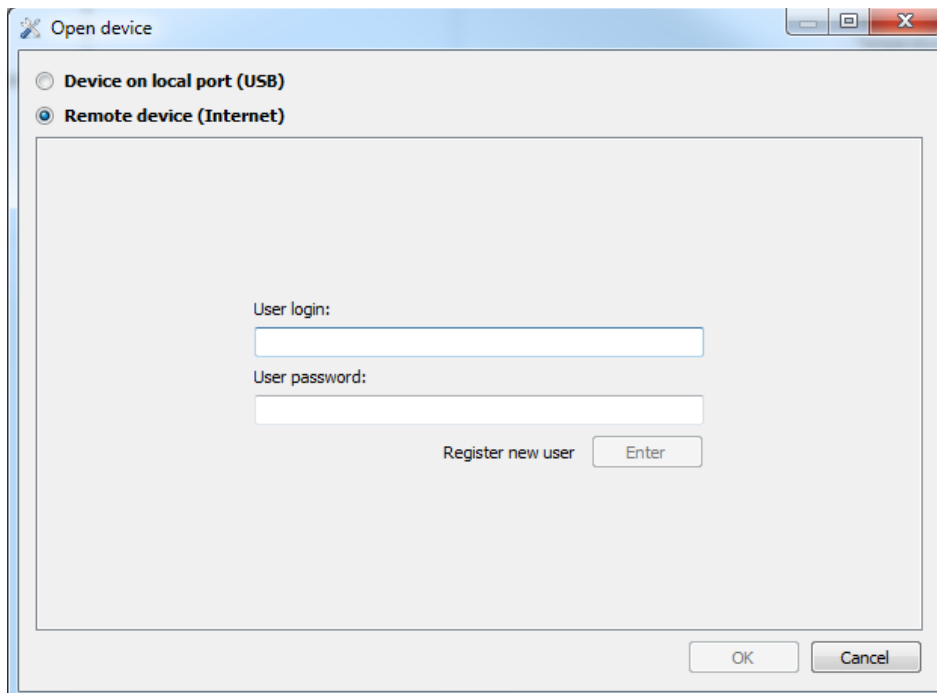

After successful authorization on the server, the form of terminals list management will become available. When connecting for the first time, the list of the controlled terminals will be empty. To add the Terminal to the list, click “Register Device” button. During registration the Configurator will request a password for a particular Terminal, a factory password corresponds to IMEI of the Terminal; this can be later changed in the Configurator by the user. Terminals may be grouped.

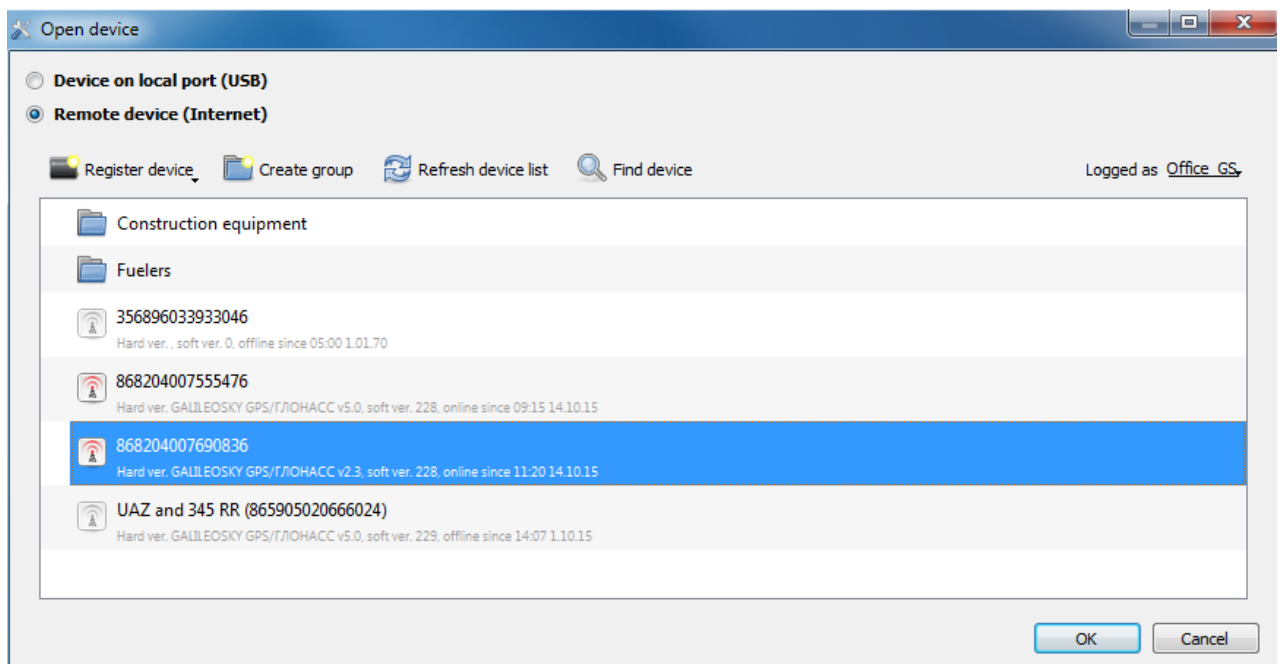

After selecting a particular Terminal, it can be controlled via Configurator, the same way as it occurs with the USB connection.

10.3. Troubleshooting tab

This tab allows us to see the current device state through the device troubleshooting reports.

The troubleshooting mode has the following buttons:

- 1) **Start /Stop**
The time scale displays the information about the server connection, packet recording, updating coordinates etc. and with a 10 sec interval.
- 2) **Clear troubleshooting window**
- 3) **Save** the Terminal's troubleshooting results as a log-file which can be opened by any text editor.
- 4) **Search** in the troubleshooting history file.

GSM unit debug info

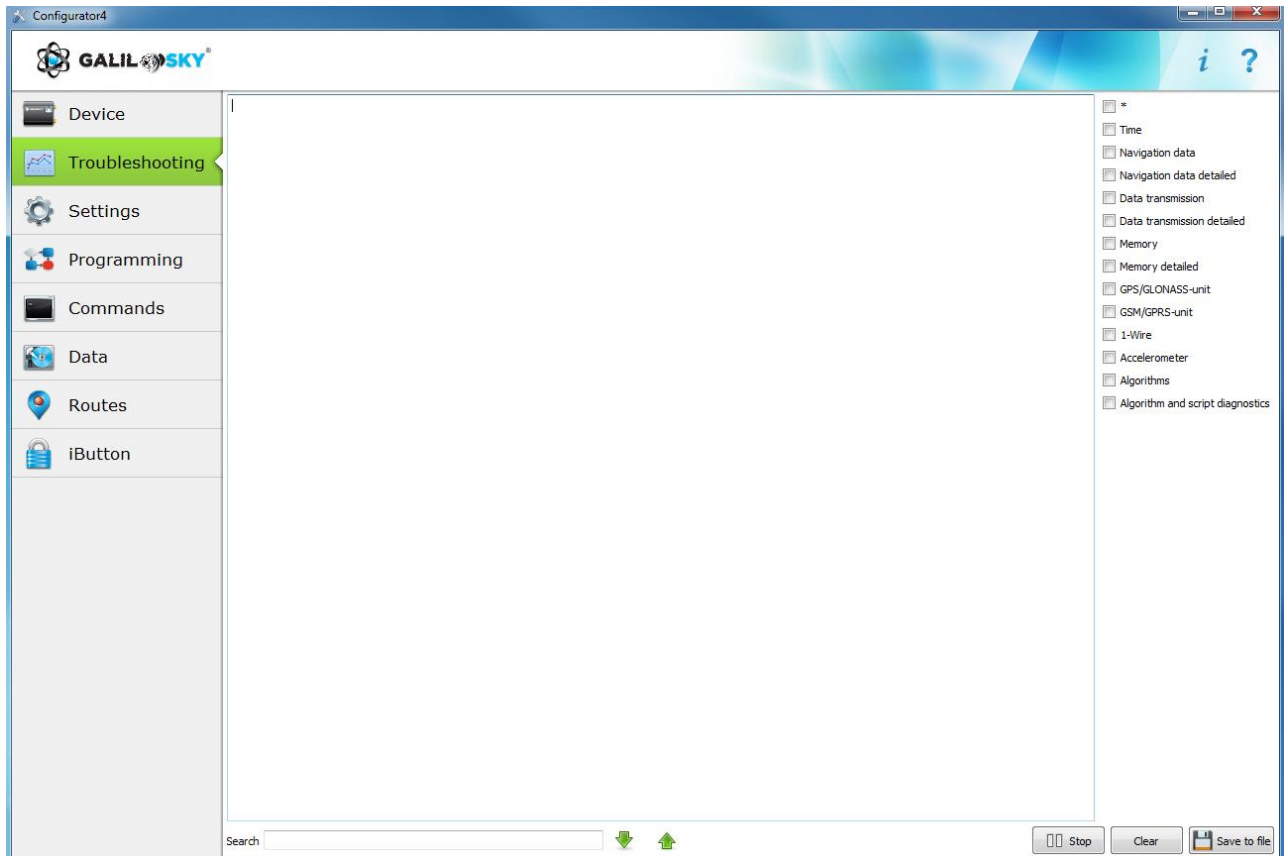

Troubleshooting messages	Description	Possible causes
GSM. Success turn on.	GSM unit is powered. Turning on is successful.	
GSM. Not success turn on!	GSM unit is powered. Turning on is denied by the unit.	
GSM. Success unit.	GSM unit initialization is successfully performed.	
GSM. Not success unit!	GSM unit initialization failed.	
GPRS. Activated.	GPRS service initialization is successfully performed.	
GPRS. Not activate.	GPRS service initialization failed.	GPRS is not activated on this SIM card. Not enough money on the account. GSM network is overloaded.
GPRS. Success connect to server.	Device server connection is successful.	

BOXFINDER (0001) User's Manual

GPRS. Not success connect to server.	Device server connection is failed.	The Server access is denied or wrong server settings for the device.
GPRS. Reconnect Number=N _o	Number of server reconnections. N _o - reconnection number.	
GPRS. Firstpack OK.	First packet has been sent to the server.	
GPRS. Firstpack False.[0]	The device has sent the first packet, but there is no confirmation at TCP/IP level.	GSM network is overloaded. The packet has been blocked by device brandmauer or FireWall.
GPRS. Firstpack False.[1]	The device has sent the first packet, but there is no confirmation at the application level.	GSM network is overloaded. The server is not handling the first packet.

SMS debug info

Troubleshooting message	Description
SMS. RX SMS.	A new SMS message is received
SMS. TelNum: +79112299922	received from a given phone number
Command: ID	ID command is received
SMS. TX OK.	Message is successfully sent
SMS delfromslot 1	handled SMS deleting (from the first SIM card slot)
Not reply SIM. Slot 1	no SIM card reply (from the first SIM card slot)
GSM. No SIM-card	no SIM card reply (the card is probably not inserted)

Internal Flash-memory (tracks memory) debug info

Troubleshooting messages	Description
MEM. Write point – 200	Point with sequence number 200 is recorded.

GPS-unit debug info

Troubleshooting information	Description	Possible causes
SAT. Coord refresh.	Coordinates for current record have been updated by GPS unit. The vehicle is considered to be moving, packet has not been filtered off.	
SAT. Coord not refresh.	Coordinates for current record have not been updated. Filtering at stops is activated.	
SAT. Temper is low than -40	Device temperature is lower than -40°C. Operation at lower temperatures is impossible.	
SAT. Temper is high than 65	Device temperature is higher than +65°C. Operation at higher temperatures is impossible.	
GLONASS. Message received. Len = 401	Terminal received information from GLONASS unit. 401 byte is received.	
GPS. Message received. Len = 172	Terminal received information from GPS-module. 171 byte is received.	
GPS. Change baud rate = 1	Attempt to set GPS unit rate. Attempt № 1.	
SAT. Fix = 1	Current position is fixed (0 – not fixed);	
SAT. SatInUse = 7	7 satellites are used for navigation;	
SAT. Valid = 1	Coordinates are right (they can be used for location determination). This <i>Valid</i> is not related to <i>valid</i> in packet and status.	
Galileo uses GLONASS	Terminal uses GLONASS system.	
SAT. Incorrect data from GLNS/GPS module	Wrong data are received from the used unit (probably because of processor overload)	
SAT. Time out. Restart MCU	Terminal gets no data from receivers (GLNS/GPS)	
SAT. High Speed = 200	Navigation speed data filter turned on (these data will be skipped by the unit).	

BOXFINDER (0001) User's Manual

SAT. HDOP is high = 6	Navigation HDOP data filter turned on (these data will be skipped by the unit).	
SAT. Jump = 5000	Navigation coordinate data filter turned on (leap to large distance occurred).	
SAT. First start OK. Sat count >= MIN	By the Terminal turning on, the unit must get more MIN satellites (only in this case, the data are reliable).	

10.4. Command mode tab

This tab is intended to message a single command or a set of commands to the Terminal. The command mode has the following buttons:

- 1) **Run commands;**
- 2) **Run single command;**
- 3) **Open from file;**
- 4) **Save to file.**

The commands will be identified whether you use capital or lower-case letters or both in turn.

Attention!

There are no spaces in command name!

Spaces between parameters are not allowed!

Commands and parameters are separated by space.

Commands are separated by Enter.

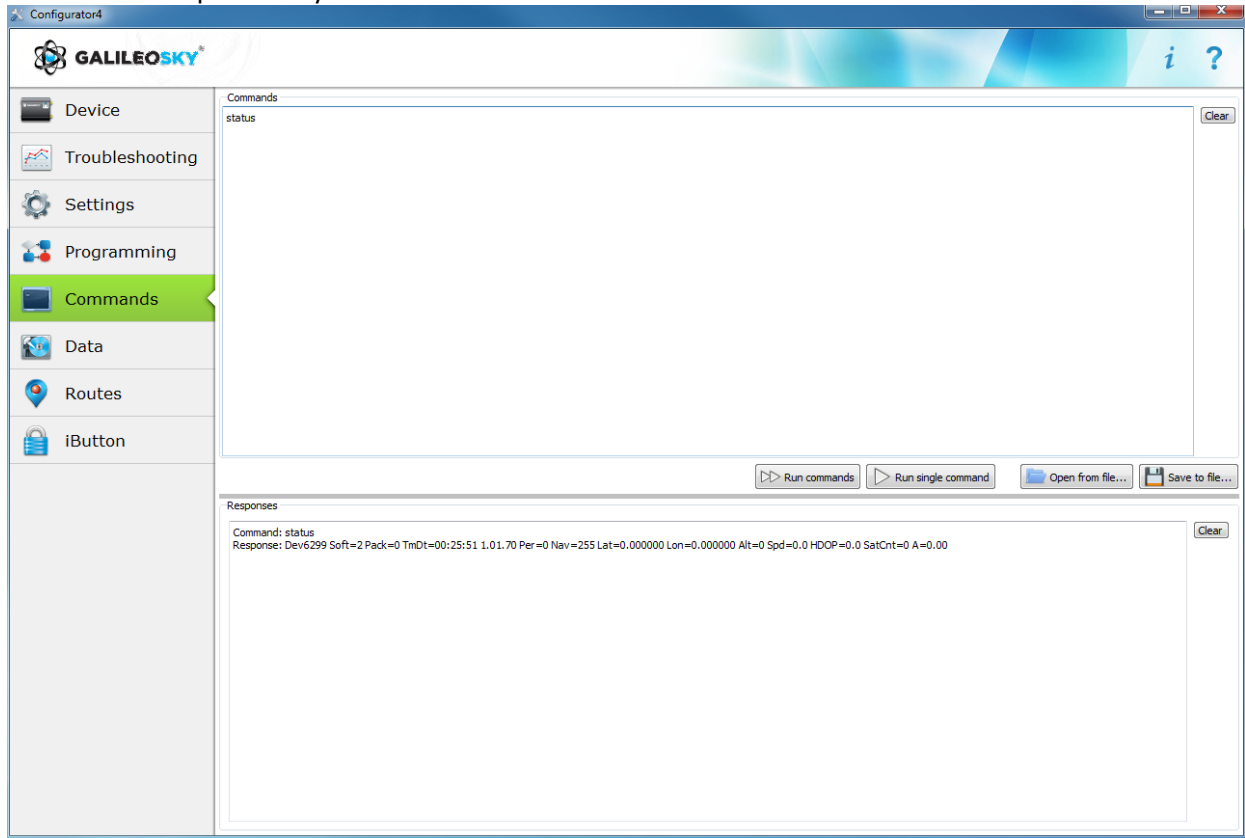

Single command example

An example of a command with a parameter:

Enter APN internet.beeline.ru,beeline,beeline as shown in the figure above and press **Run single command** button. The command and a response will be displayed in the Responses window.

Command: APN internet.beeline.ru,beeline,beeline

Response: GPRS: APN=INTERNET.BEELINE.RU, user=BEELINE, pass=BEELINE

To access the parameters in the Terminal memory you should use a command without parameters!

An example of a command without a parameter:

"APN" command	Request: APN Response: GPRS:APN=INTERNET.BEELINE.RU, user=BEELINE, pass=BEELINE;
---------------	---

Set of commands example

Enter the necessary commands in Commands window, each beginning a new line, as shown in the figure below and press the **Run commands** button.

Example: Serverip 55,34,76,123,30100

 ID 6299

 HeadPack 1110

The given commands and results will be displayed in the Responses window.

Command: Serverip 55,34,76,123,30100

Response: ServerIp=55.34.76.123:30100

Command: ID 6299

Response: ID: 6299

Command: HeadPack 1110

Response: HeadPack = 0001110b

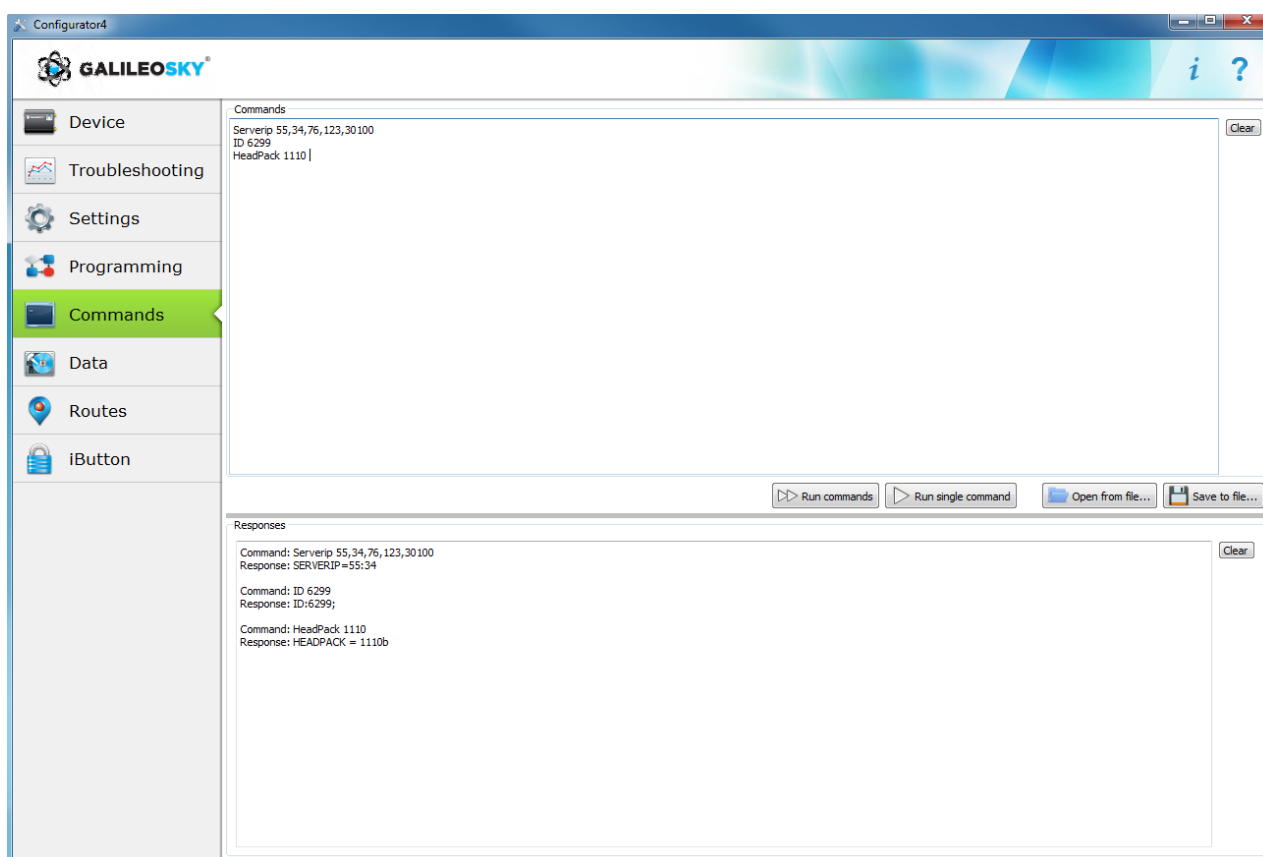

Example of saving and downloading parameters set

For quick configuration of several Terminals with the same set of commands, it is recommended to run the commands from a pre-saved file. To do this, enter a list of commands in the Command window. Make sure that they are typed correctly by pressing the **Run commands** button and then press **Save to file**

The file will be saved in log configurator folder. Then press "**Open from file...**" button.

To run several commands at the same time press **Run commands** button.

To run only one command, it is necessary to go to it in Commands window and press **Run single command** button.

10.5. Graphic interface settings

All main settings of the Terminal are placed on tabs in the program upper part.

10.5.1. Security

This tab allows setting SIM-cards PIN code, phone authorization password, list of authorized phone numbers and encryption key for data transfer to the server.

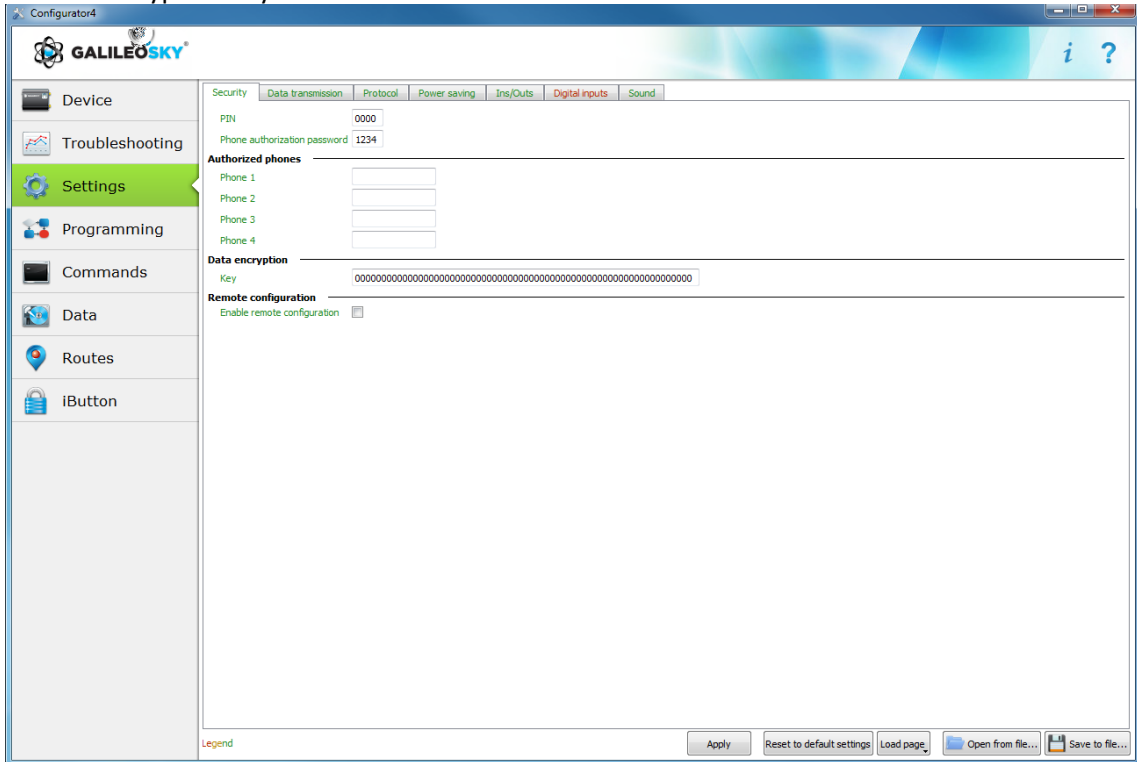

10.5.2. Data transmission

This tab allows setting SIM-card PIN code, APN for the Internet access, monitoring data processing servers, packet data transmission and international roaming.

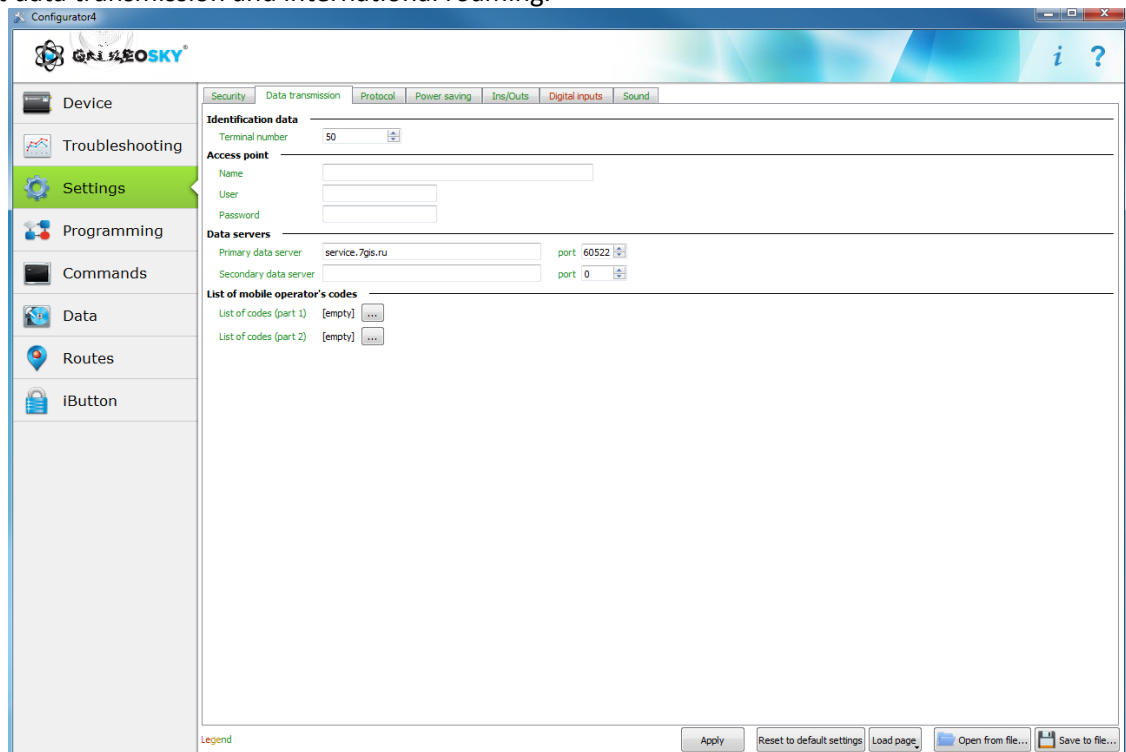

10.5.3. Protocol

The Terminal has its own data transmission protocol developed by RSA "GALILEOSKY", LLC. This tab allows setting exact monitoring parameters sending to the server.

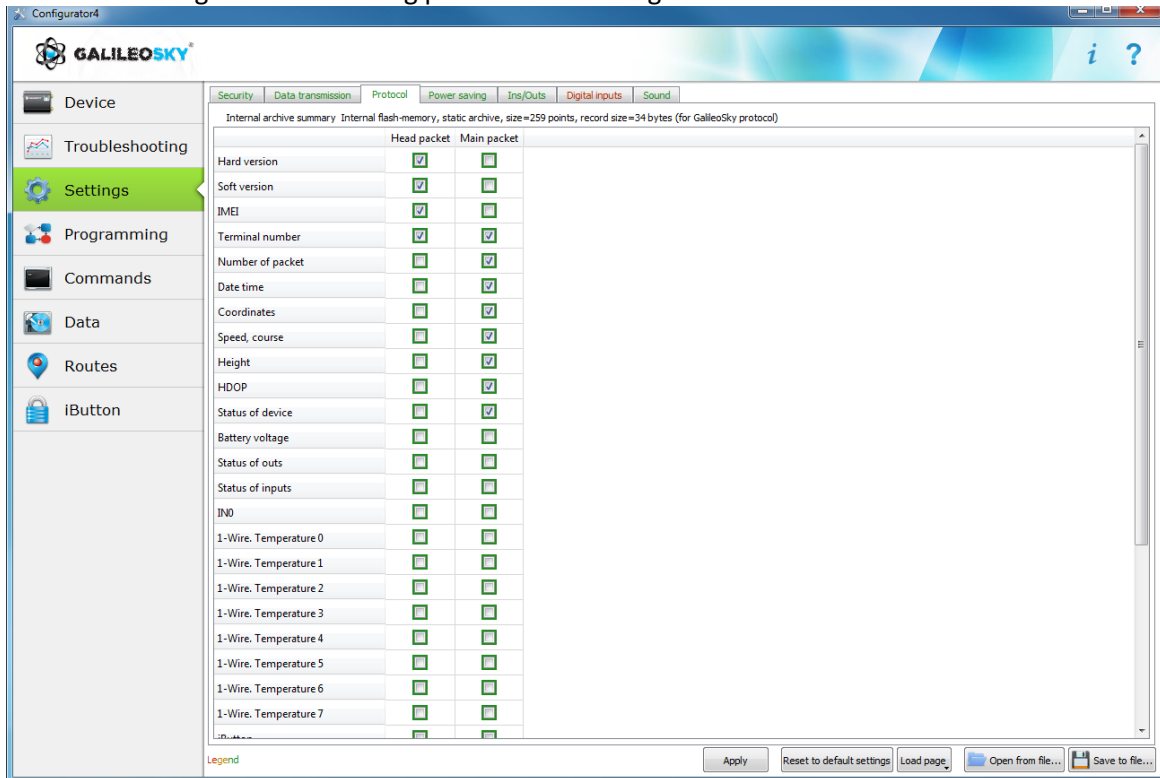

10.5.4. Power saving

This tab allows setting shutdown options of the Terminal units at stop, to reduce power consumption.

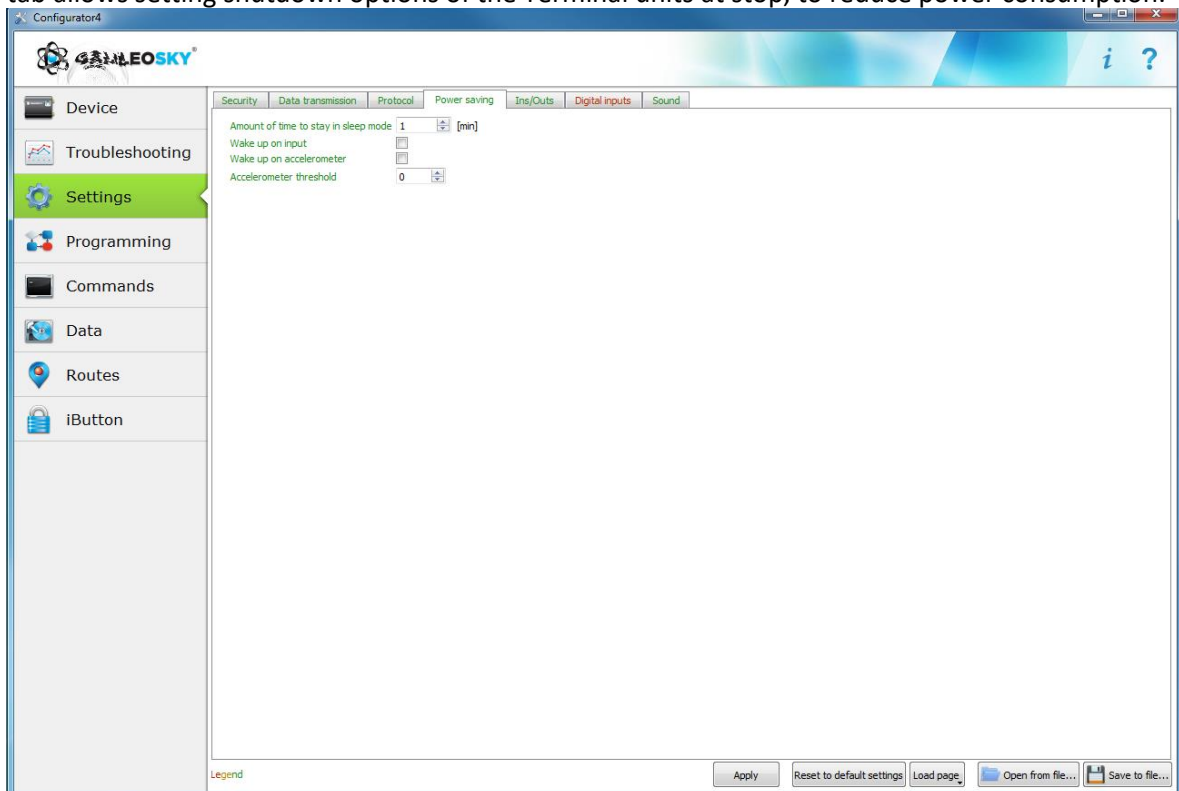

10.5.5. Inputs/outputs

This tab allows setting functions of input and relay state.

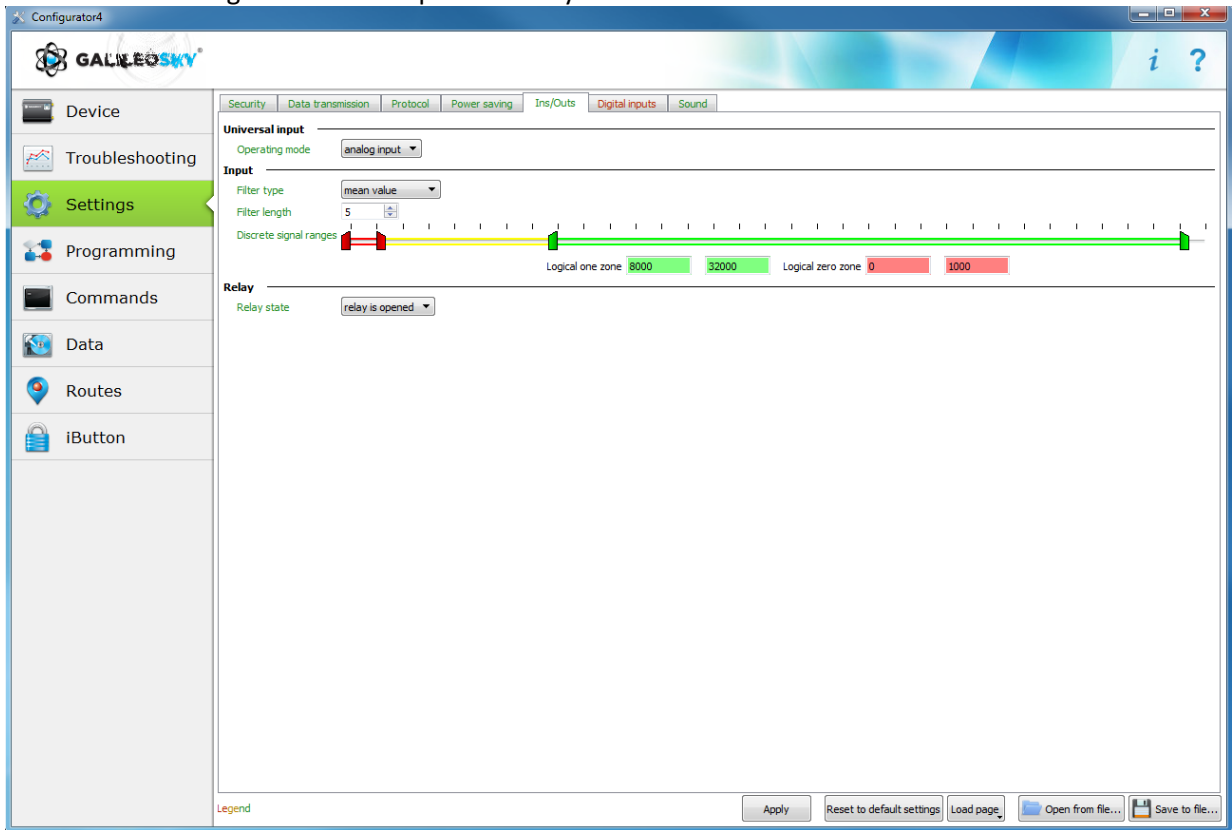

10.5.6. Digital inputs

This option allows setting iButton identification keys.

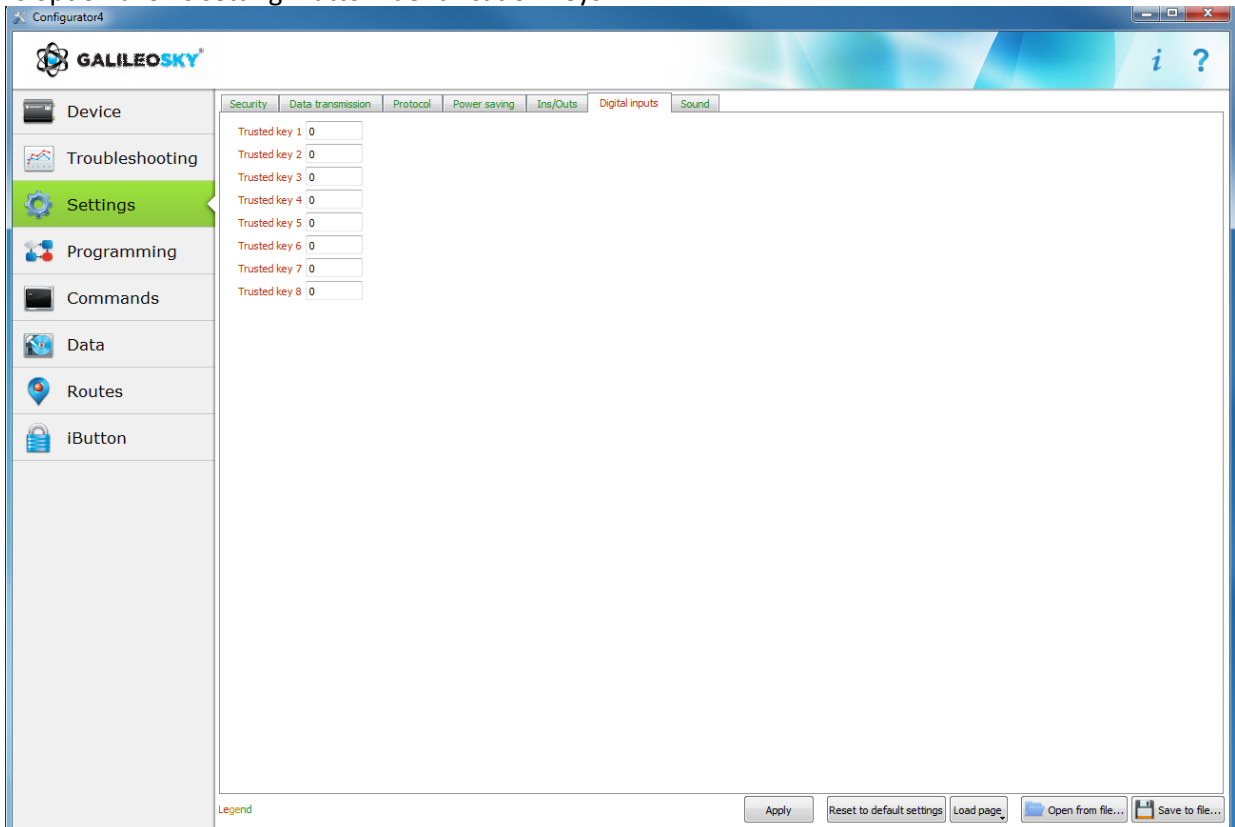

10.5.7.Sound

This option allows setting a microphone and sound gain via a GSM channel, it also allows setting the number of calls before auto answer.

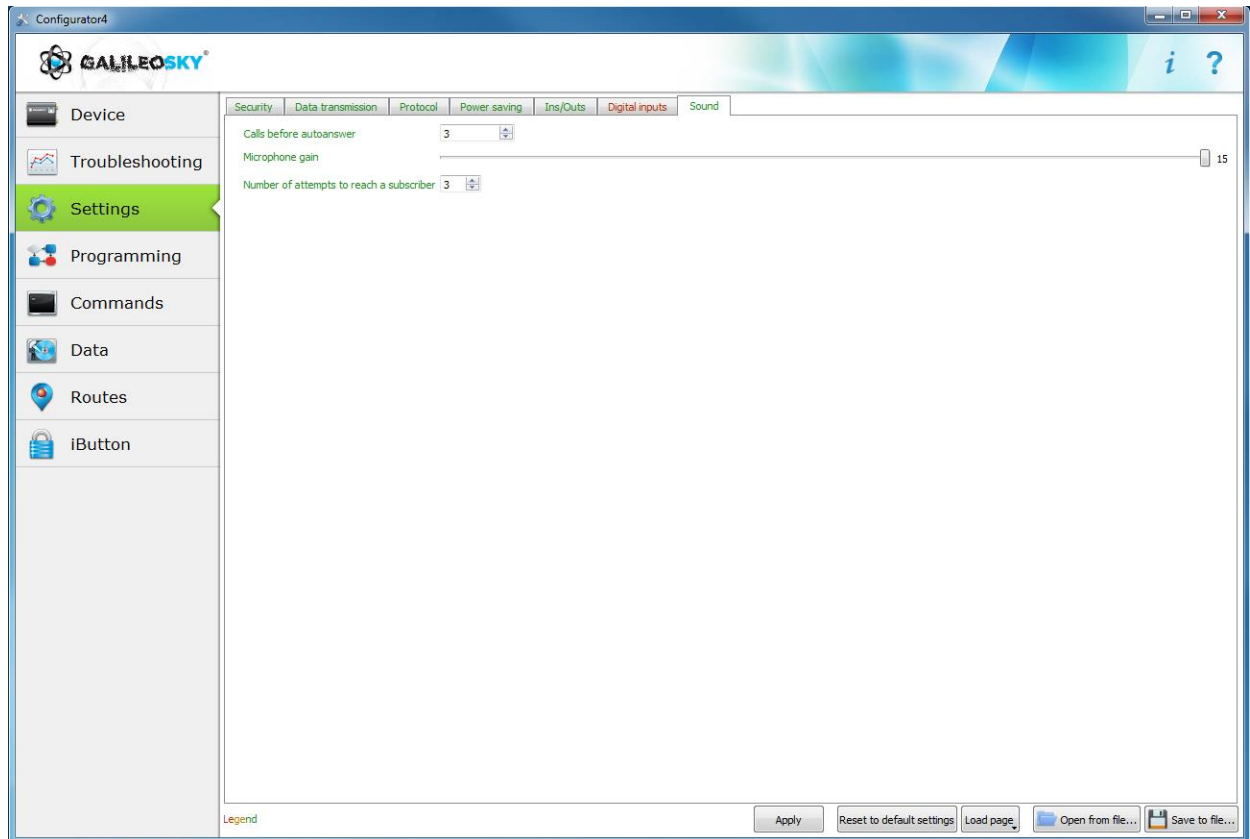

10.6. Data loading and sending to server

10.6.1. Data loading from the Terminal to file

This option allows transferring the data from the internal memory to computer files via a USB cable. By data loading from the internal memory one InternalFlash.csv file will be created.

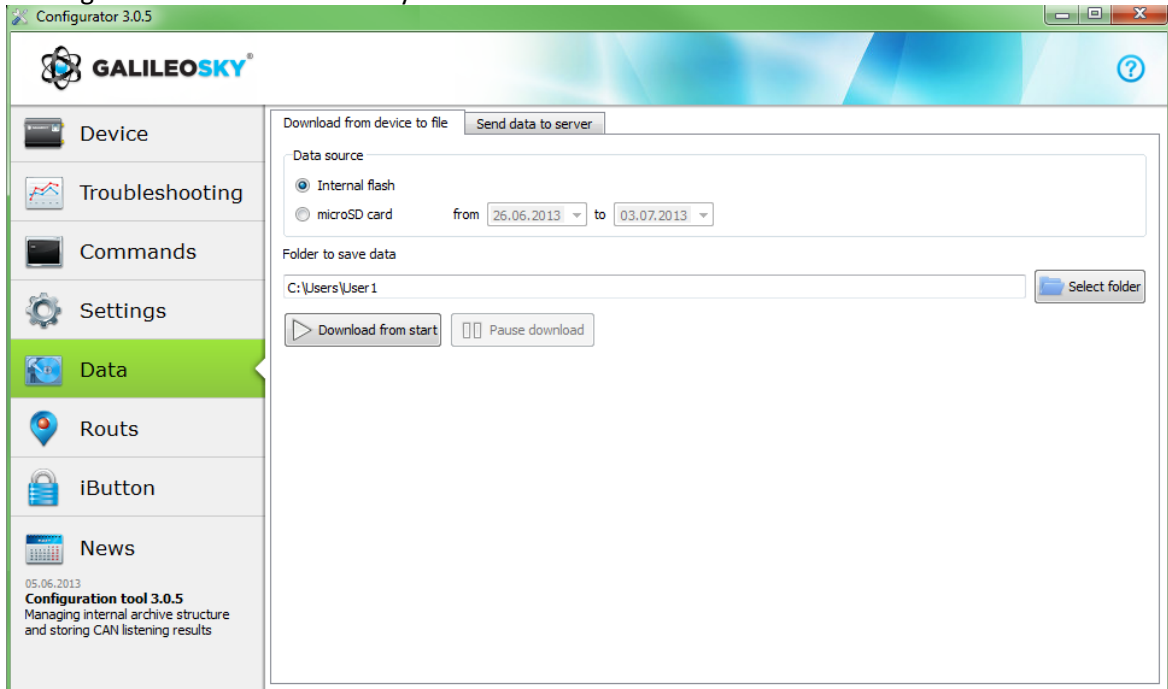

The Data transfer from the internal memory can be stopped and resumed.

10.6.2. Sending data to server

This option allows sending the data previously transferred from the Terminal to any server emulating the GALILEOSKY protocol. To send it, you should specify the IP-address and the server port and choose a file or a catalogue to be sent. If a catalogue is chosen, the program will send all its data files. The process can be stopped and resumed.

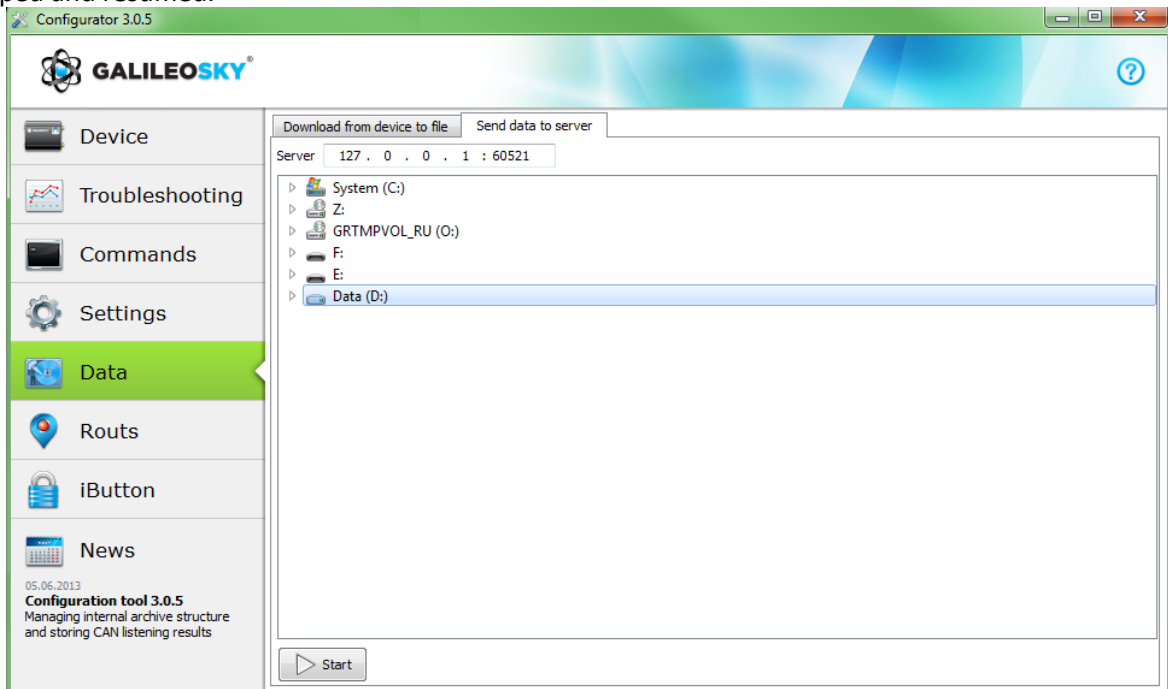

11. Commands list

To request current settings you need to issue a command without any parameters.

11.1. Setting for SMS control

Command format **AddPhone xxxx[,n]**

Parameters	xxxx - is a four-digit password, 1234 by default n – slot number (0-3) where a telephone number will be saved.
Explanation	When you configure the Terminal from a cell phone, you should first authorize it by using the command. Up to 4 telephone numbers can be authorized.
Example	Request: AddPhone 1234 Reply: Phones (0)=89010123456 (1)= (2)= (3)=

Command format **ChangePass aaaa**

Parameters	aaaa – is a numeric four-digit password;
Explanation	Changing and viewing the current password.
Example	Request: ChangePass 5678 Reply: Password changed to '5678'

Command format **Phones P1,P2,P3,P4**

Parameters	P1,P2,P3,P4 – authorized phone numbers written in international format
Explanation	Getting and setting the list of authorized phones
Example	Request: Phones +7901012345,,, Reply: Phones (0)=+79010123456 (1)= (2)= (3)=

11.2. Data transmission settings

Command format **APN a,u,p**

Parameters	a – access point name; u – user; p – password.
Explanation	Access point settings for SIM0
Example	Request: APN internet.beeline.ru,beeline,beeline Reply: GPRS:APN=internet.beeline.ru, user=beeline, pass=beeline

Command format **OPS0 n1,n2,n3,n4,n5,n6,n7,n8,n9,n10,n11,n12,n13,n14,n15**

Parameters	n1-n15 – preferred GSM-networks.
Explanation	A list of preferred GSM-networks for SIM0. The network is defined by a mobile country code and a mobile operator code (the list of codes is given in http://www.itu.int/dms_pub/itu-t/opb/sp/T-SP-E.212A-2010-PDF-E.pdf), for example, the Russian Federation code is 250.
Example	Request: OPS0 25001,25099 Reply: OPS0:25001,25099,,,,,,,,,,,,;

Command format **OPS02 n16,n17,n18,n19,n20,n21,n22,n23,n24,n25,n26,n27,n28,n29,n30**

Parameters	n16-n30 – preferred GSM-networks.
Explanation	Additional list of preferred GSM-networks for SIM0.
Example	Request: OPS02 25001,25099 Reply: OPS02:25001,25099,,,,,,,,,,,,;

BOXFINDER (0001) User's Manual

Command format	Serverip host,port
Parameters	host - domain name of a server or its IP-address; port - server port.
Explanation	Main server parameters where the monitoring data will be transmitted to.
<i>Example</i>	Request: Serverip m.7gis.ru,60521 Reply: SERVERIP=m.7gis.ru:60521 Request: Serverip 46.146.233.216,60521 Reply: SERVERIP=46.146.233.216:60521

Command format	Serverip2 ip1,ip2,ip3,ip4,port
Parameters	host – domain name of a server or its IP-address; port - server port.
Explanation	Parameters of additional server.
<i>Example</i>	Request: Serverip2 m.7gis.ru,60521 Reply: Serverip2= m.7gis.ru: 60521

Command format	ID n
Parameters	n – terminal number.
Explanation	Changes the number of the terminal.
<i>Example</i>	Request: ID 123 Reply: ID=123

11.3. Server exchange protocol settings

Command format HeadPack bbbbbbbbbbbbbbb	
Parameters	bbbbbbbbbbbbbb – tag set from 1 to 128. If b is replaced by 1, the tag is on. If b is replaced by 0, the tag is off. Tag numeration order is given in GALILEOSKY protocol parameters
Explanation	Head packet configuring.
Example	<i>Request: HeadPack 1110</i> <i>Reply: HeadPack= 0001110b</i> <i>This means that tags from the second to the fourth inclusive are on, and the first and the rest tags inclusive are off.</i>
Command format HeadPack2 bbbbbbbbbbbbbbb	
Parameters	bbbbbbbbbbbbbb – tag set from 129 to 256. If b is replaced by 1, the tag is on. If b is replaced by 0, the tag is off. Tag numeration order is given in section GALILEOSKY protocol parameters
Explanation	Head packet configuring.
Example	<i>Request: HeadPack2 110000</i> <i>Reply: HeadPack2=110000b</i> <i>This means that tags 129, 130,131,132 are off and tags133 and 134 are on. All the following tags are off</i>
Command format HeadPackBit index,value	
Parameters	index – is tag number, which is on or off for transmission to the server value – 1 if the tag should be transmitted to the server 0 if tag should not be transmitted to the server Tag numeration order is given in section GALILEOSKY protocol parameters
Explanation	Head packet configuring.
Example	<i>Initially the second tag is off:</i> <i>HeadPack=1100b</i> <i>Switch on this tag.</i> <i>Request: HeadPackBit 2,1</i> <i>Reply: HeadPack=1100b</i>
Command format MainPack bbbbbbbbbbbbbbb	
Parameters	bbbbbbbbbbbbbb – tag set from 1 to 128. If b is replaced by 1, the tag is on. If b is replaced by 0 the tag is off. Tag numeration order is given in section GALILEOSKY protocol parameters .
Explanation	Head packet configuring.
Example	<i>Request: MainPack 111111111111111111110000</i> <i>Reply: MainPack=00000000000000000000001111111111111111110000b</i> <i>This means that tags 1, 2, 3, 4 are off and tags 5-266 inclusive are on. All the following tags are off.</i>

BOXFINDER (0001) User's Manual

Command format	MainPack2 bbbbbbbbbbbbbbb
Parameters	bbbbbbbbbbbbbb – tag set from 129 to 256. If b is replaced by 1, the tag is on. If b is replaced by 0 the tag is off. Tag numeration order is given in section GALILEOSKY protocol parameters .
Explanation	Head packet configuring.
Example	<i>Request: MainPack2 110000</i> <i>Reply: MainPack2=110000b</i> <i>This means that tags 129, 130, 131, 132 are off and tags 133 and 134 are on. All the following tags are off.</i>

Command format	MainPackBit index,value
Parameters	index –tag number, which is on or off for transmission to the server value – 1 if this tag should be transmitted to the server 0 if this tag should not be transmitted to the server Tag numeration order is given in section GALILEOSKY protocol parameters .
Explanation	Head packet configuring.
Example	<i>Initially the second tag is off:</i> <i>HeadPack=1100b</i> <i>Switch on this tag.</i> <i>Request: HeadPackBit 2,1</i> <i>Reply: HeadPack=1100b</i>

Command format	DataKey key
Parameters	key – data encryption key in hexadecimal form, if it is equal to 0, data are not encoded.
Explanation	Specifies the key that encrypts the transmitted data.

11.4. Information commands

Command format	Status
<i>Explanation</i>	Allows finding device status at the moment of sending a command. Dev – this device number; Soft – current firmware version number; Pack – last recorded serial packet serial number; TmDt – current time and date; Nav – coordinates determination accuracy. 0 – coordinates are found. Lat – latitude; Lon – longitude; Speed – linear speed (vehicle speed); HDOP – horizontal accuracy (the closer to 1, the better); SatCnt – number of available satellites; A – movement directional angle
<i>Example</i>	Request: Status Reply: Dev50 Soft=91 Pack=17230 TmDt=10:58:6 20.06.09 Nav=0 Lat=60.4007 Lon=31.0070 Speed=0.0194 HDOP=0.88 SatCnt=10 A=27.55

Command format	Imei
<i>Explanation</i>	Allows obtaining a unique GSM unit identifier, 15 byte
<i>Example</i>	Request: IMEI Reply: IMEI 123456789012345

Command format	Imsi
<i>Explanation</i>	Allows obtaining a unique IMSI identifier of the SIM-card
<i>Example</i>	Request: IMSI Reply: IMSI 123456789012345;

Command format	Inall
<i>Explanation</i>	Allows getting data through analog input.
<i>Example</i>	Request: inall Reply: INALL:in0=0;

Command format	Insys
<i>Explanation</i>	Allows obtaining voltage on internal battery.
<i>Example</i>	Request: insys Reply: INSYS:Vbat=4196;

Command format	Temex0
<i>Explanation</i>	Allows finding temperature from the first four external DS18S20 thermometers. Format: the lower byte is the thermometer identifier; the higher byte is the temperature itself. To calculate the temperature the obtained value must be divided by 256 and rounded off to the whole number, with the fractional part deleted.
<i>Example</i>	Request: temex0 Reply: TemEx0: DS0=0,DS1=0,DS2=0,DS3=0

Command format	Temex1
<i>Explanation</i>	Allows finding temperature of the second four external DS18S20 thermometers. Format: the lower byte is the thermometer identifier; the higher byte is the temperature itself. To calculate the temperature the obtained value must be divided by 256 and rounded off to the whole number, with the fractional part deleted.
<i>Example</i>	Request: temex1 Reply: TemEx1: DS4=0,DS5=0,DS6=0,DS7=0

Command format	Canibut
----------------	----------------

BOXFINDER (0001) User's Manual

Explanation	Allows obtaining connected iButton identification keys decimal value and connection state of 8 set trusted keys
<i>Example</i>	Request: canib Reply: CAN_Ib: iB=0,iB2=0,iButState=0;

Command format **Statall**

Explanation	Allows obtaining statuses of inputs and decimal relay.
<i>Example</i>	Request: statall Reply: StatAll: Ins=2,Outs=1;

11.5. Service commands

Command format **BSleep SleepTimeout,WakeUpByInput,WakeUpOnShock,ShockValue**

Parameters	SleepTimeout – time in “sleepmode” in minutes; WakeUpByInput – switching to operating mode while input responding; WakeUpOnShock – switching to operating mode while determination of strike; ShockValue – vibration value, which determines the strike, 600 = 1g.
Explanation	Allows configuring the Terminal's behavior in “sleepmode”.
<i>Example</i>	Request: BSleep 100,0,1,60 Reply: BSLEEP:SleepTimeout=100,WakeUpByInput=0,WakeUpOnShock=1,ShockValue=60;

Command format **PIN N**

Parameters	N – four-digit PIN-code of SIM cards.
Explanation	SIM card PIN-code and password setting for access settings in the Configurator. The default PIN-code is 0. If you enter the wrong code, the Terminal will be blocked for 25 seconds, and then reset.
<i>Example</i>	Request: PIN 1234 Reply: PIN:1234;

Command format **EraseCfg**

Explanation	Setting default configuration.
<i>Example</i>	Request: EraseCfg Reply: ERASECFG

Command format **EraseTrack**

Explanation	Deleting all tracks from the memory.
<i>Example</i>	Request: EraseTrack Reply: ERASETRACK

Command format **ColdStart**

Explanation	GLONASS unit's cold start.
<i>Example</i>	Request: ColdStart Reply: GLONASS cold start

Command format **Reset**

Explanation	Allows resetting the device remotely.
<i>Example</i>	Request: Reset Reply: Reset of device. Please wait 15 seconds...

Command format **Upgrade N**

Parameters	N – number of upgrading firmware. If 0 is set, the Terminal will be upgraded for the last available firmware.
Explanation	Upgrading firmware to the set one.
<i>Example</i>	Request: Upgrade 47 Reply: UPGRADE SOFT=47

Command format **RemoteConfig OnOff**

Parameters	OnOff – turning on the remote configuration function: 0 – remote configuration is off; 1 – remote configuration is on.
Explanation	Turning on and off the remote configuration (section " Remote configuration ")
<i>Example</i>	Request: RemoteConfig 1 Reply: REMOTECONFIG:1;

11.6. Voice communication settings

Command format **GSMVolume m**

Parameters	m – GSM-channel microphone gain [1÷15]. The greater the parameter, the greater the gain.
Explanation	Allows setting speakerphone sound gain parameters.
<i>Example</i>	Request: GSMVolume 15 Reply: GSMVOLUME=15

Command format **AutoAnswer n**

Parameters	n – the number of calls before autoanswer. [0÷10] If the parameter is equal to 0, the function is off.
Explanation	Incoming call results in the terminal automatic answer.
<i>Example</i>	Request: AutoAnswer 1 Reply: AUTOANSWER=1

Command format **Calls N**

Parameters	N – the number of call attempts
<i>Example</i>	Request: Calls 3 Reply: CALLS:3;

Command format **RingTo N**

Parameters	N – a telephone number.
Explanation	Making a call from the Terminal to the given telephone number.
<i>Example</i>	Request: RingTo 89119988899 Reply: RINGTO=89119988899

Command format **SendSMS Tel,Msg**

Parameters	Tel – a telephone number to which SMS is sent Msg – SMS template. It may contain parameters to insert current data: %IMEI – terminal's IMEI, %LAT – latitude, %LON – longitude.
Explanation	Sending SMS to the given telephone number.
<i>Example</i>	Request: SendSMS 89119988899,Test Reply: SMS sheduled

11.7. Universal input setting

Command format	BInCfg F
Parameters	F – input performance mode: 0 – analog-frequency; 1 – 1-Wire.
Explanation	Allows configuring universal input working mode.
<i>Example</i>	Request: BInCfg 1 Reply: BINCFG:1;

Command format	InCfg0 ft,fl,up_low,up_hi,down_low,down_hi,imp_null
Parameters	ft – filter type: 0 – average count; 2 – frequency count. fl – filter length. It is used for the functions of average and discrete signal; up_low – lower limit of a discrete signal triggering, [mV]; up_hi – upper limit of a discrete signal triggering, [mV]; down_low – lower limit of a discrete signal failure, [mV]; down_hi – upper limit of a discrete signal failure, [mV].
Explanation	Allows you to configure the operating limits for the external power input.
<i>Example</i>	Request: InCfg0 0,10,8000,15000,0,3000 Reply: INCFG0:FiltType=0,FiltLen=10,UpLow=8000,UpHi=15000,DownLow=0,DownHi=3000;

11.8. Relay setting

Command format	Out 0,s
Parameters	s – preferred state (0 – relay is closed; 1 – open).
Explanation	Relay control
<i>Example</i>	Request: Out 0,1 Reply: OUT = 1

12. GALILEOSKY protocol parameters

The number of bit is entered in commands mainpackbit and headpackbit to select parameters transmitted to the server.

Bit №	Description
1	Terminal version
2	Firmware version
3	IMEI
4	Device's identifier
5	Number of an archive record
6	Date and time
7	Coordinates in degrees, number of satellites, indication of coordinates determination correctness
8	Speed in km/h and direction in degrees
9	Height, m
10	HDOP, if the source of coordinates is GLONASS/ GPS-module. CEP-radius, if the source of coordinates is basic cellular network stations.
13	Internal battery voltage, mV
16	Relay status
17	Status of inputs, bit mask: The lower bit – activating on IN input. The second bit – low level of battery charge. The third bit – activating opening sensors.
18	Input value. In accordance with settings, voltage is in mV or frequency is in hz.
24	Thermometer's identifier 0 and measured temperature, °C
25	Thermometer's identifier 1 and measured temperature, °C
26	Thermometer's identifier 2 and measured temperature, °C
27	Thermometer's identifier 3 and measured temperature, °C
28	Thermometer's identifier 4 and measured temperature, °C
29	Thermometer's identifier 5 and measured temperature, °C
30	Thermometer's identifier 6 and measured temperature, °C
31	Thermometer's identifier 7 and measured temperature, °C
32	Identification number of the first iButton key
52	Identification number of the second iButton key
54	State of iButton keys, identifiers of which are set buy command iButtons

13. Bootloader

The processor program (firmware) is a set of algorithms developed by RSA "GALILEOSKY", LLC. specialists. Owing to this program, the central processor receives the data from different system units, processes them logically and mathematically and takes decisions for control commands of controller units to be worked out depending on the situation.

Bootloader is a Terminal's sub-program allowing the main program part (hereinafter referred to as Firmware) being updated.

The main program can be downloaded via the USB or GPRS-channel in the Terminal.

13.1. USB channel download

- 1) Connect the USB cable; the device must be defined on the computer;
- 2) Launch the Configurator, open the "Device" tab and click "Upgrade firmware";
- 3) Select a firmware from the list;
- 4) Updating process will be reflected in the lower part of Configurator;
- 5) After reflashing, the device will reset and enter the operating mode in 15 seconds.

13.2. GPRS channel download

- 1) Connect the Terminal to the external power supply;
- 2) APN settings must conform to the SIM card inserted in the Terminal, otherwise, the device flashing will not happen, and the Terminal will return to the operating mode.
Give the following command: "UPGRADE firmware№" using any of the available channels (SMS, GPRS, USB), where firmware№ is the necessary firmware version. "UPGRADE 0" initiates downloading the latest firmware;
- 3) You may see if the flashing is in progress by LEDs blinking;
- 4) In 10-15 minutes (depending on connection conditions and GPRS terms of service by operator) upgrade will be completed and the Terminal will turn into operation mode automatically.

13.3. Using universal input to enter bootloader mode

- 1) Open the cover of battery unit;
- 2) Take the battery;
- 3) Transmit voltage $7.0B \pm 0.2B$ to universal input (sector "[Contacts description](#)");
- 4) Connect the battery; opening sensor should not be pressed.

This function is used when incorrect firmware is recorded.

Incorrect firmware is a firmware used for terminals with different functionality.

13.4. LED operation during reflashing

Depending on the GSM modem and microcontroller units' activation stages, the device Terminal will go through the following stages:

Yellow LED blinking, times	GSM Modem activation stage
6	Procedure of GSM unit activation was successful.
5	GPRS service registration was successful.
4	Establishing firmware update connection to the server.
3	The Terminal switched to downloading mode.
2	Server connection is not lost, and the Terminal is in downloading mode.
1	First request sending was successful.

14. Additional information

1. Certifying

The device Terminal is certified to comply with GOST R.

2. Warranty

RSA "GALILEOSKY", LLC. hereby guarantees the realization of consumers' rights provided by the local laws throughout Russia and the CIS.

RSA "GALILEOSKY", LLC. guarantees the operability of the device terminal subject to compliance with the instructions set out in the above user's manual.

2.1 Warranty conditions

The warranty period is 24 months since the day of purchase.

Note: a defective device terminal (with cracks and fissures, dents and impact marks, etc.) due to consumer's fault resulting from inappropriate maintenance, storage and transportation is not liable to warranty. The above also holds for a device without the body or battery.

In case the guarantee document proving the device sale to the customer does not contain the date of purchase, the name and seller's seal, the warranty period starts since the day of production.

The consumer has the right for free maintenance in the manufacturer's service center if a production or design defect appeared during the warranty period. The consumer has the right for maintenance during the whole period of operation of the device. The consumer has all the other rights provided by the laws of the Russian Federation and the CIS.

If the failure cause cannot be found at the moment of appeal, a technical examination is held, which cannot exceed 30 days since the moment of appeal.

The warranty does not apply in case of:

- Inappropriate transportation, storage or maintenance described in User's Manual;
- Unauthorized opening the device during the warranty period;
- Repairing controller by someone or some organization not authorized by RSA "GALILEOSKY", LLC. during the warranty period;
- Signs of electrical and/or other damage due to prohibitive mains parameter changes, misapplication and neglect of the device;
- Physical damage of the device body and board, SIM holder, aerials or wires break;
- Traces of oxidation of outer and inner parts or exposure of the device body to moisture;
- Theft or criminal damage of the external aerial or cable;
- Damages caused by foreign objects, substances, liquids, insects coming into body;
- Damages caused by exposure to high temperature or intense microwave radiation;
- Damages caused by elemental forces, fire, social factors, random external factors and accidents;
- Damages caused by parameters incompatibility or inappropriate attachment of additional devices or sensors to the terminal;
- Operation of the terminal at the in vehicle network voltage deviating from the range mentioned in technical specifications;
- Damages caused by inappropriate Terminal's installation in the vehicle;
- Failure in Terminal's performance due to incompatibility of software and Terminal versions.
- Connection socket, contacts and SIM-holders are not covered under warranty.
- Warranty period for a processor, GSM module, GLONASS/GPS module – 34 (thirty-four) calendar months from the moment of realization note in device passport, but not more than 36 (thirty-six) calendar months from the moment of device shipping to the Buyer from the Manufacturer storage included in delivery note.

Attention! The manufacturer shall in no case be liable for claims concerning the damage or loss of the data exceeding the cost of the product, as well as claims for incidental, special or consequential damages (including in any case, without limitation, damages for inability to use the equipment, loss of the

BOXFINDER (0001) User's Manual

data, loss of business, loss of profit, loss of savings, loss of time), arising out of the use or inability to use the equipment within legal limits.

Attention! The Warranty does not affect the statutory rights of the consumer, such as the guarantee of satisfactory quality of work or conformity of the product to the purpose for which analogous products are used under normal conditions and service maintenance and also your rights with regard to the seller of the product resulting from the fact of purchase and contract of sale and purchase.

Attention! Terms of Warranty service which are in conflict with the current law have no legal effect and are subject to the current law.

Attention! If the Purchaser fails to comply with the Terms of Warranty, the validity of the Warranty is void.