



User Manual of Galileosky 5.1

firmware 0229



Contents

Introduction	5
Package	7
Technical Specifications.....	8
Physical Specifications	9
Safe Operating Rules.....	9
Contacts Description	10
Connecting.....	11
Connecting GLONASS aerial.....	11
Connecting GSM/3G- aerial	11
Inserting SIM-card	11
Connecting power supply to the device.....	12
LED indicators.....	12
Terminal Units Performance	13
Discrete-analog inputs (DAI).....	13
Pulse count.....	14
Mean value and discrete event generation	14
Frequency count	15
Frequency count from two synchronously connected sensors.....	15
Determination of strike and incline.....	15
Economical driving "EcoDrive" and determination of the driving style.....	16
Data archiving to the micro SD card	17
Autoinformer function	17
Signaling function	19
Monitoring data transmission.....	20
Internal Archive Structure	20
Operation with two SIM-cards	21
GPRS traffic costs optimization	21
Operation in international roaming	22
Stels mode and packet transmission.....	22
Geofences	23
Power saving	23
Remote configuration.....	24
Connecting External Peripheral.....	25
CAN-interface.....	25

J1939_SCANER mode.....	25
FMS mode.....	26
J1939_USER_29bit mode.....	26
J1979_SCANER mode.....	27
J1979_29bit mode	28
Different variants of connection to the CAN-bus.....	28
Connecting digital fuel sensors using RS232 protocol	29
Connecting digital fuel sensors using RS485 protocol	30
Connecting Galileosky photo camera to the device	31
Connecting 1Wire sensors.....	33
Connecting iButton (DS1990, DS1982) identification key	33
Connecting DS18S20 (DS1820, DS18B20) thermometers and DS1923 temperature and humidity sensors.....	34
Connecting Autoinform speaker.....	35
Connecting audio equipment.....	35
Transistor outputs (0/1)	37
Connecting passenger flow registration SH2 sensors.....	37
Connecting Garmin navigators supporting FMI protocol.....	38
Connecting REP-500 electrical meter	39
Connecting CAN-LOG.....	40
Connecting CUB5B indicator.....	40
Connecting CI5010A weight indicator.....	41
Connecting Tenzo-M weight indicator.....	41
Connecting AWT 640 weight indicator.....	42
Connecting WIN SCALE weight indicator.....	42
Connecting Matrix 5 RFID-codes reader using RS485 interface	43
Connecting DBG-S11D dosimeter using RS485 interface.....	43
Connecting PressurePro tires pressure monitoring system.....	43
Connecting CarrierDataCOLD500, ThermoKing, Euroscan refrigeration units temperature recorders	44
Configurator.....	45
Program installation and running.....	45
Device tab	46
Troubleshooting tab.....	48
Command mode tab.....	52
Graphic interface settings.....	54
Security.....	54
Data transmission.....	54
Protocol	55
Power saving.....	55

User Manual Galileosky 5.1

Track	56
Inputs/Outputs.....	57
Digital inputs.....	57
Sound	58
Signaling	58
CAN	59
Geofences.....	59
Data loading and sending to server	60
Data loading from the Terminal to file.....	60
Sending data to server	61
Routes for Autoinformer	62
Trusted iButton keys.....	63
Commands List.....	64
Settings for SMS control	64
Data transmission settings.....	65
Galileosky server exchange protocol settings	70
Track parameters setting.....	73
Geofences settings.....	77
Information commands.....	79
Service commands.....	83
Voice communication settings	87
Analog-discrete inputs setting	89
Transistor outputs setting.....	91
Autoinformer setting	91
Digital inputs settings.....	92
Signaling mode setting	97
CAN settings	102
Packet transmission, energy saving, Stels mode settings	104
Photo camera operation settings	104
Bootloader	106
USB channel download	106
GPRS channel download	106
Using analog inputs to enter bootloader mode.....	106
LED operation during reflashing	107
Galileosky Protocol Data.....	108
Additional Information	113

Introduction

RSA "Galileosky", LLC produces satellite monitoring equipment (hereinafter – terminals) for GPS and GLONASS real time vehicles monitoring. The Terminals determine the mobile object location recording the time and route as points with geographical coordinates and send the data to the server to be further processed and sent to the traffic controller panel.

In addition, a number of other vehicle parameters are recorded: the state of analog and discrete inputs of the Terminal and the state of digital interfaces.

The Terminals can be used in any vehicle.

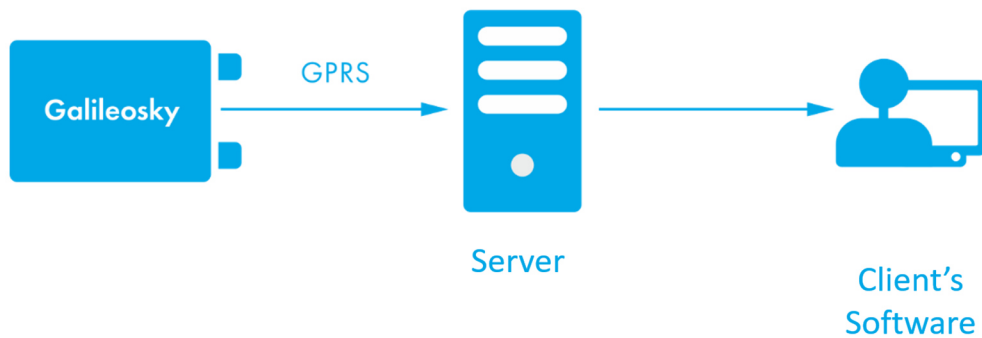

Galileosky Terminal receives a signal about its location from GPS, GLONASS satellites and processes input and output data

Information is sent to the server by means of GPRS and then via the Internet to the operator panel.

To prevent the data from disappearing when there is no GSM/3G signal, each Galileosky Terminal has an internal nonvolatile FLASH memory. The terminal also has a built-in battery, which allows operation for 8 hours.

The terminal provides the following opportunities:

- ✓ vehicles monitoring in real time;
- ✓ a detailed turn by turn track (without any extra points in a straight track);
- ✓ voice communication with the traffic dispatcher;
- ✓ GSM/3G enabled remote software update;
- ✓ continuous troubleshooting of the Terminal through the USB port;
- ✓ car alarm and a remote engine start;
- ✓ securing facilities against intrusion;
- ✓ automatic stops announcement;
- ✓ adjusting the Terminal through SMS, GPRS, USB;
- ✓ and others (see sections [Terminal units performance](#) and [Connecting external peripheral](#)).

User Manual Galileosky 5.1

The information sent by the terminal includes:

- ✓ the exact Greenwich time and date;
- ✓ vehicle coordinates: latitude, longitude, height;
- ✓ vehicles speed and direction;
- ✓ vehicle acceleration;
- ✓ inside temperature;
- ✓ inputs (buttons) and analog sensors state;
- ✓ external digital sensors state (fuel, temperature sensors and etc.);
- ✓ discrete outputs state;
- ✓ and others (see details of transmitted data in section [Galileosky protocol data](#))

In addition, the company provides warranty service and technical support on its site.

Before starting the work study the instruction carefully.

Package

The standard package includes the Galileo terminal (hereinafter referred to as the Terminal) and a pin connector with contacts. Everything extra should be bought separately.

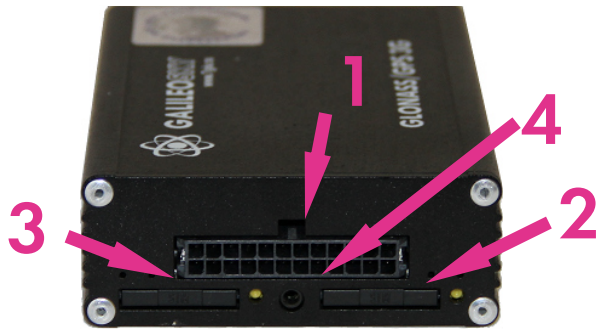

Exposed face

- 1. Main connector
- 2. SIM 0
- 3. SIM 1
- 4. Alarm button connector

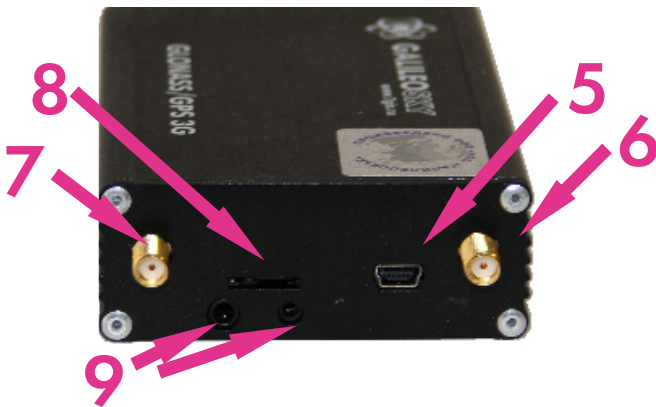

Rear end

- 5. Mini USB (B-type)
- 6. GSM/3G-aerial connector
- 7. GPS/GLONASS-aerial connector
- 8. microSD
- 9. Push-to-talk connector

The Terminal has 4 LED indicators which show its current status: red (external power supply), yellow (microcontroller), green (GPS or GLONASS receiver), and blue (GSM/3G modem). See section [LED indicators](#).

You will also need:

1. USB-cable	1
2. GLONASS aerial	1
3. GSM/3G aerial	1
4. Power supply unit 9-39V (15 W)	1

Technical Specifications

Parameter	Modification 2	Modification 21
Analog-discrete and pulse frequency inputs	8 pcs; voltage range -0-33V; Maximum measured frequency-4 kHz; Input resistance of every input is 14 kOhm to the ground.	
Transistor outputs (output 0/1)	4 pcs; maximum voltage 30V; maximum current 80mA.	
Battery type	Li-Ion battery; 600mAh	
Average power consumption	0,96 W	
ADC resolution in bits	10	
Archive capacity	up to 58 000 points by having 2 MB flash memory; up to 450 000 points by having 16 MB flash memory; up to 2 500 000 points for each GB by using micro SD card	
1-Wire	Yes	
CANBUS	J1939, FMS, J1979, OBD II, 29-bit and 11-bit identifiers	
RS232	1	
RS485	1	
USB 2.0	Terminal setting, troubleshooting, reflashing	
microSD	Maximum memory of supported card is 32 GB	
Speakerphone	KMC-25 push-to-talk	KMC-25 push-to-talk; a speaker and a microphone
Speaker (Autoinformer)	built-in	
The number of geofences for voice prompts	Limited by the microSD card capacity	
Speaker output type	analog (linear output), 250mW	
The size of a data packet sent by the device	1.Galileosky protocol: variable-length protocol, tag format 2.EGTS (GOST R 54619-2011, Order № 285 of the RF Ministry of Transportation).	
Accelerometer	built- in	
GLONASS/GPS receiver	Response level, not less than 161 dBm Cold start 25 s.;; Hot start 1 s.	
Coordinates determination accuracy, 95% of time, not worse	5 m	
GSM modem	GSM 900/1800, GPRS class 12	
3G modem	UMTS, WDCMA 900/2100, GPRS class 12	
2 SIM-cards support	Yes	
Alarm button connector	Yes	
Enclosure protection	IP54	

Physical Specifications

Operating temperature range	-40...+85 °C
Storage temperature	-40...+85 °C
Relative humidity	0...90% (0...35 °C); 0...70% (35...55 °C)
Performance (height above the sea level)	0-2000 m
Storage	0-10000 m
Continuous work form battery	depends on the Terminal settings, 8hrs on average
External power supply	9-39V; is protected against voltage jumps in the vehicle power supply
Dimensions	104,0 mm x 72,0 mm x 28,0 mm
Weight	within 300g
Body material	Metal
Warranty	2 years since the purchase date;
Average service life	10 years
Internal Li-Ion battery life	500 charge/discharge cycles, three years maximum

Safe Operating Rules

Before using the Terminal study the instructions of GSM/3G/GPRS devices safe operating.

Make sure the polarity is correct when connecting to the power supply.

The device should be connected straight to the vehicle battery, not to the vehicle power supply.

ATTENTION! To avoid failure:

- Make sure the contacts are connected correctly!
- Unused contacts must be well insulated!

The ground is connected to the device body. In order not to damage the Terminal or the vehicle's electronics, it is necessary to separate the device body and the vehicle.

Contacts Description



Contact	Description
VCC	Positive supply voltage
GND	Negative supply voltage
IN0	Zero analog-discrete input
IN1	1 st analog-discrete input
IN2	2 nd analog-discrete input
IN3	3 rd analog-discrete input
IN4	4 th analog-discrete input
IN5	5 th analog-discrete input
IN6	6 th analog-discrete input
IN7	7 th analog-discrete input
RXD	RXD signal of RS232 channel
TXD	TXD signal of RS232 channel
RS485A	A signal of RS485 channel
RS485B	B signal of RS485 channel
CAN_H	CAN interface CAN_H contact
CAN_L	CAN interface CAN_L contact
Vol0	Zero contact to connect an external speaker for Autoinforme
Vol1	First contact to connect an external speaker for Autoinforme
1-Wire	1-Wire interface
GND	Ground to connect interfaces which need the ground contact
Out0	Zero transistor output (output 0/1)
Out1	First transistor output (output 0/1)
Out2	Second transistor output (output 0/1)
Out3	Third transistor output (output 0/1)

Connecting

Connecting GLONASS aerial

Carefully screw the aerial to the Terminal, the upper side is above. To have a better view of the sky it is recommended that the aerial should be mounted on the vehicle roof, windscreen or under the dashboard.



If GLONASS aerial is mounted correctly, your coordinates will be found in 1.5 minutes. To be sure see that the green LED indicator is on (see section [LED indicators](#)).

Connecting GSM/3G- aerial

Carefully screw the aerial to the Terminal.

The GSM/3G-aerial should be mounted in such a way to prevent the GSM/3G signal from fading because of the vehicle body, for example, under the dashboard or outside the vehicle.



To make sure the GPRS modem is sending data see that the blue LED indicator is on (see section [LED indicators](#)).

Inserting SIM-card

Use a SIM-card with activated GPRS and SMS services.

Insert the card carefully without applying excessive force.

- 1) To eject the SIM holder press the indicated place as shown in the picture with something sharp (needle, toothpick);
- 2) Insert the card so that it is completely hidden in the holder cover.

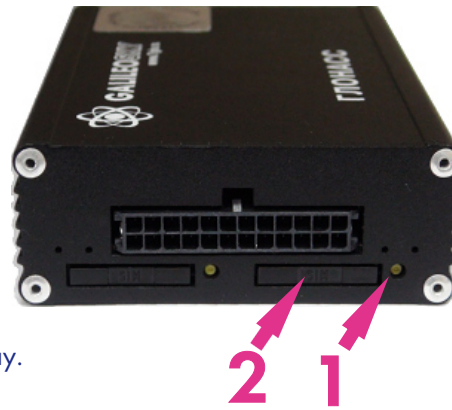

The second SIM-card should be inserted in a similar way.

Connecting power supply to the device

Positive supply voltage should be connected to VCC contact, negative supply voltage should be connected to GND (section [Contacts description](#)). If the connection is correct, the red LED will be on.

LED indicators

Red LED - Is on when the power unit is connected to the Terminal.

Yellow LED - Is on when the microcontroller is running (blinks with the frequency of 1 Hz). It is also used to indicate the bootloader mode (section [LED operation during reflashing](#))

Green LED - Shows the GLONASS unit status.

Blinking frequency, times	Description
3	GLONASS unit is not found or is at the initialization stage
2	GLONASS unit is found but correct coordinates are absent
1	GLONASS unit works properly, coordinates are found and updated once a second

Blue LED - Shows the GSM/3G-unit status.

Blinking frequency, times	Description
4	Stels mode (GSM/3G-unit is off and is set to be on according to schedule)
3	GSM/3G-unit is not found or is at the initialization stage
2	GSM/3G-unit is found, GPRS-session is activated
1	GSM/3G-unit works properly, server is connected

Terminal Units Performance

Discrete-analog inputs (DAI)

To attach external sensors the terminal has 8 discrete-analog inputs which are pulse-frequency at the same time. Each input's function is set in the Terminal settings (sections Discrete-analog inputs setting and [Inputs/outputs](#)). In section [Contacts description](#) inputs are designated as IN0, IN1, IN2, IN3, IN4, IN5, IN6, IN7.

Each input saves its values to the nonvolatile memory, i.e. in case if the channel is set to be a pulse one, the pulse number value will be restored after resetting the device.

Feature	Value
Maximum measured voltage	33 V
Analog inputs resolution	33 mV
Maximum transmitted signal frequency	4 kHz (synchronous measuring at 1 input) 3.5 kHz (synchronous measuring at 2 inputs) 1.5 kHz (measuring at 4 inputs)

DAI have the following settings:

Parameter	Explanation
Filter type (input function)	0 - arithmetical average (discrete input state is also generated); 1 - pulse count; 2 - frequency input; 3 - pulse count from two synchronously connected sensors.
Filter length to calculate the mean value	The greater this parameter, the more slowly the device responds to the input signal change. With filter length equal to 1 - averaging does not happen. Set this parameter to 1 for frequency inputs. It is necessary to set this parameter to 1 for pulse inputs. If the Terminal counts extra pulses, the filter length should be increased by one and accuracy estimated.
Ranges for response/nonresponse areas (logical 1 and 0)	To process discrete signals, discrete signal response/nonresponse range should be set where signals equal to one and zero. Discrete inputs states should be seen in the Status Of Inputs field, but not in the Input voltage fields. While counting pulses or frequency, it is necessary to put the value equal to half the pulse value into all the fields of the given group (example: the pulses' amplitude is 5000 mV, so all the fields must take the value 2500 mV) While counting pulses from 2 synchronously connected sensors, response zone limits must be the same and equal to half of pulse value at response of one of the sensors. Non-response zone limits are equal to half of pulse value at two sensors simultaneous response.

Pulse count

In case of a renewable counter the maximum pulse number can be 65535, after that the number is reset to zero.

If there is pulse at input, the correspondent bit will be set in the Status of Inputs field, and a point will be recorded. If there is no another pulse for 30 seconds, the bit returns to 0.

Mean value and discrete event generation

Example 1.

Let us consider the example with the following zero input setting (see the left-hand figure):

Filter type is 0;

Filter length is 5;

Logical one zone range is 8-33V;

Logical zero zone range is 0-3V.



Example 1



Example 2

The mean value is calculated continuously and is put into the corresponding field IN0.

At the same time, it is continuously checked whether the calculated value belongs to the given range.

If it is in the range 8-33V, the corresponding bit will find itself in the Status of Inputs field and a point will be recorded.

By value coming into the indifference zone (3V-8V), the former bit value will be saved to the Status of Inputs field.

If the value is in the logical zero zone (0V-3V), the corresponding bit in the Status of Inputs field is reset.

Thus, we can see that the given bit can change its state only in the logical one/logical zero zones.

Example 2.

In contrast to example 1 (see the right-hand figure) the logical one zone and the logical zero zone have changed places.

In the same way it is possible to set zones of response and non-response for the Terminal`s power supply voltage (POWINCFG command, section [Analog-discrete inputs setting](#)). The state of discrete signal for input can be identified according to the 8th bit of the Status of the device field.

Frequency count

To measure frequency in some sensors it is necessary to connect the sensor frequency output to the sensor positive power supply via a 1kOhm resistor. Otherwise, frequency count is impossible.

Frequency count from two synchronously connected sensors

The Terminal allows connection of 2 pulse sensors on one input, in this case, pulse fronts number is count, i.e. for each sensor response counter value increases by 2. Connection circuit details are given in section [Connecting passengers flow registration SH2 sensors](#).

Determination of strike and incline

All devices can determine the Terminal`s strike and incline.

Accelerometer axis directions:



Accelerometer axis directions:

To determine strike:

1. Install the Terminal so as one of the accelerometer axis looks vertically, it will exclude false detections on road bumps;

2. Turn on strike and incline determination by SHOCK command (section [Track parameters setting](#)). For example, if Z axis is vertical: SHOCK 3,90,5,1200.

A strike is an acceleration increase in horizontal plane; the correspondent bit is put in the Device state field and strike coordinates are recorded.

To determine incline:

1. Install the Terminal in vehicle;
2. By SHOCK command set maximum allowable incline angle and allowable time of this angle exceeding. For example, a maximum angle is 20°, allowable exceed time is 5 seconds; SHOCK 3,20,5,1200.

On the Terminal homing position change in a vehicle, SHOCK command should be given to adopt the Terminal to a new position.

Economical driving "EcoDrive" and determination of the driving style

The Terminal can detect rapid acceleration, braking, harsh turns and strikes on bumps. For correct operation of this function, the terminal must detect its orientation in space with respect to the vehicle (the direction to the ground). The driving style data are stored only if dynamic archive is enabled, FLASHARCHIVE 1 command (section [Service commands](#)).

The default orientation of the terminal:



Direction to the ground

The default orientation of the terminal:

If the terminal cannot be installed as illustrated by the picture, user-defined installation may be performed with the subsequent calibration of orientation.

To determine the position of the terminal in respect to the vehicle, perform the following steps:

1. Install the Terminal to ensure its rigid link with the vehicle's body;
2. Ensure the horizontal position of the vehicle;
3. Execute the shock 0 command, which determines the direction of the terminal to the ground.

Data on the driving style can be sent using the mainpackbit 174,1 command.

Data archiving to the micro SD card

To create a backup on the microSD card it is necessary to insert it into the Terminal. If the need arises, it can be ejected from the Terminal and the data can be read in a file manager or explorer with a card reader. It is also possible to send the archive to the server. CSV-files can be opened both with a text editor and Microsoft Excel. The saved data will be ordered in the following way:

```
MSD:\Track  
  
    20100201.csv  
    20100202.csv  
    ...  
    20100331.csv
```

If there isn't enough space on the microSD card, the Terminal tries to delete the oldest files from the Track folder.

Autoinformer function

Autoinformer function may be used for automatic (without participation of the driver) public transport stops announcement with the use of a satellite navigation system.

The main difference from analogous systems is taking into account vehicle movement direction, thereby excluding false operation at other stops located in the same geographic area.

To use autoinformer:

1. Attach the speaker to the Terminal (section [Connecting autoinformer speaker](#)).
2. Set the microSD card:
 - a. Place sound files in format: wav, 16 kHz, mono, 16 bit to the card root folder. The file name must not exceed 20 symbols, including the extension, for example, PARKOVIJ.wav. The record length is recommended within 4 minutes (in case of exceeding, by the following file reproduction crackle may appear);
 - b. Create folders with routes names in the card root folder. The smallest number of routes is 1.
 - c. It is necessary to place the BusLine.txt file to the route folders, where response areas and areas linkage to the sound files are stored.

The format of each zone is the following:

- Latitude;
- Longitude;
- Direction angle α (the angle between the meridian and a vehicle direction);
- Spread for the direction angle Δ (see the diagram below);
- Outer radius of Rext response zone;
- Inner radius of Rint response zone;
- Sound file name corresponding to this zone.

User Manual Galileosky 5.1

It is convenient to fill in the information for zones from the Device tab of the Configurator while going along the route.

By route forming it is necessary to indicate separate zones for stops in both directions even if the stops are opposite each other.

Latitude and longitude values are entered through the point "." (For example: 57.9842) where the value after point – is degree fractions. To transfer minutes into degree fractions (Xdegr.Ymin.) use the following expression $Xdegr. = Ymin./60$. For example: 57 degr. 55.4513min = 57.924188 degr.

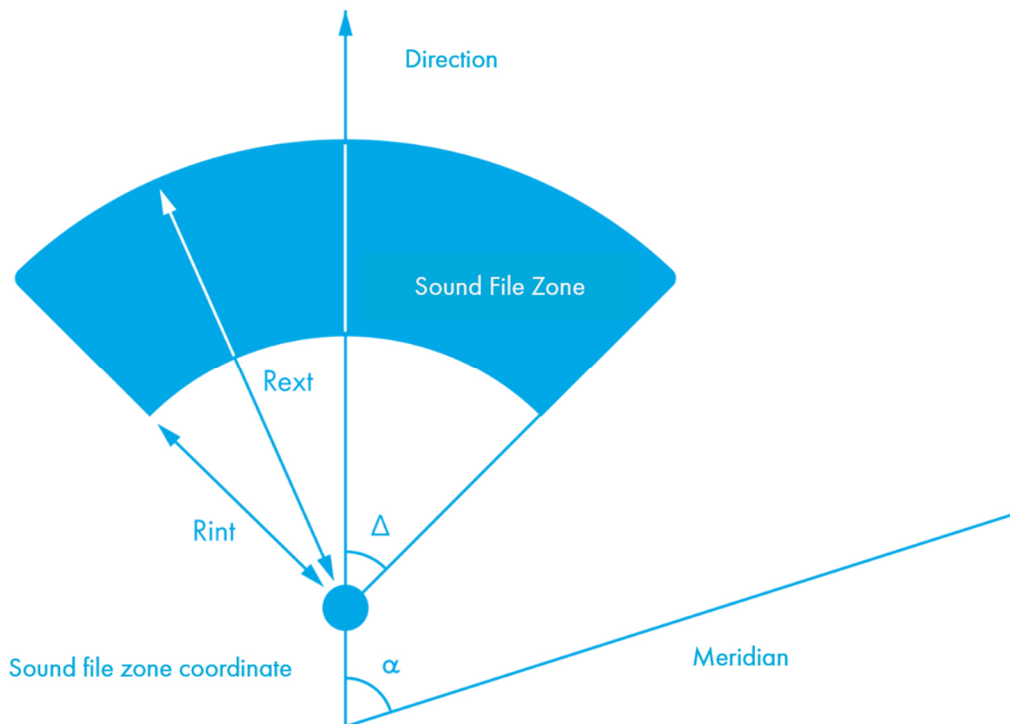

Explanatory diagram

3. Activate the Autoinformers function with the Autoinformers command (section [Autoinformers setting](#)).
4. Insert a microSD card into the Terminal and reset it with the Reset command. After the Terminal resetting the function will be activated.

In the process of sound files playback there is a 5 seconds pause between adjacent files.

To test sound files:

- 1) Unscrew GLONASS aerial from the Terminal;
- 2) Enter into file BusLine.txt the following lines:
[the following format: LAT,LON,ANGL,DELTA,RAD_EXT,RAD_INT,STRING_STATION]
0.0;0.0;12.0;180;500;0;TEST.wav
- 3) Create *TEST.wav*. file in the microSD card root. This file will be played again and again after the Terminal resetting.

Signaling function

Signaling function allows assigning the response to:

1. analog input state change;
2. strikes and inclines (accelerometer data);
3. location change;
4. speeding;
5. iButton or RFID card connection.

The Terminal can react by inverting outputs state, sending an output pulse, sending SMS, making a preset number(s) telephone call, taking a picture or recording the point.

The settings that users can change are as follows (section [Signaling mode setting](#)):

1. the time when input signals are not processed ("green wave"), with signaling enabled;
2. the maximum time of alert mode after which the Terminal will automatically change into an alarm system mode;
3. the time between activation and change to the alert mode individual for each input;
4. an SMS text message when changing to the alert mode individual for each input;
5. the time between enabling the alert mode and state change individual for each input.
6. Alarm system activation and deactivation can be made by input, SMS or server message, using the iButton key previously programmed in the Terminal (the iButtons command, section [Digital inputs setting](#)). Commands prevail over inputs states. Input activation depends on the settings given by the InCfg command (section [Analog-discrete inputs setting](#)), the level, outputs are inverted with respect to, is set by the Out command (section [Transistor outputs setting](#)).

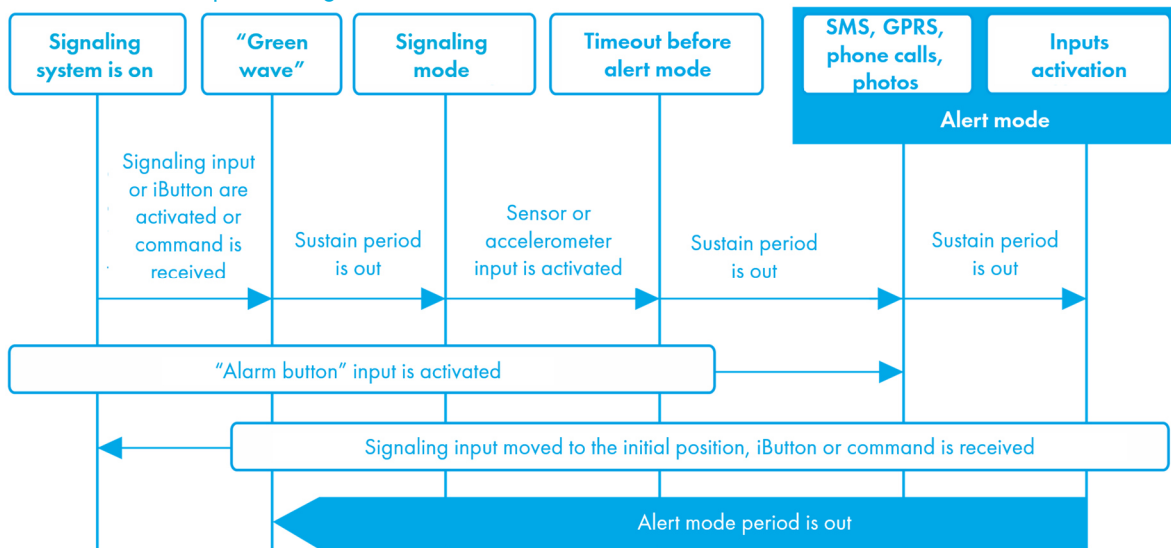

Monitoring data transmission

Terminal allows specifying the list of preferred GSM/3G-networks. The main priority is given to the networks from the beginning of the list. Every network is specified with country's code and network operator's code. Terminal supports up to 30 networks (OPSO command, section [Data transmission settings](#)). If it is impossible to connect to one of the preferred networks, the Terminal connects to any network but doesn't establish connection to the server, thus voice communication and SMS will be available according to a tariff of the installed SIM-card.

The Terminal allows data transmission to the main and backup monitoring servers. If there is only transfer to the main server set, continuous connection will be maintained. If there is transfer to both servers set, the Terminal is connected to the main server and then after the set period of time it breaks the communication and connects to the backup server and etc. The Terminal accounts transmitted data separately for each server, thus both will receive full archive with the track.

Data can be transmitted according to the Galileosky or EGTS protocol (Protocol command, section [Data transmission settings](#)).

By using the EGTS protocol the Terminal's number parameter (ID command, section [Data transmission settings](#)) specifies the object number by the authentication.

By using the Galileosky protocol transmitted data can be coded; XTEA3 algorithm (<http://tomstdenis.tripod.com/xtea.pdf>) is used for coding. Commands, responses and photos are not coded. The data are archived in the internal flash-memory by default. During long periods without connection the oldest records of the internal flash-memory may be erased by the new ones. In this case, it is recommended to insert a microSD card and to adjust archive transmission from it (Archive command, section [Service commands](#)).

Internal Archive Structure

The data archive can be stored on the internal flash memory or a micro-SD card. The internal flash memory card is used by default.

The Terminal stores the data from all the inputs and interfaces, even when they have no connected sensors, in the internal flash memory archive. If it is unnecessary to store all the data, the dynamic archive can be used (FLASHARCHIVE command, section [Service commands](#)). In this case, only the data selected in configuration of the head and main packets will be saved (HEADPACK and MAINPACK commands, section [Server exchange protocol settings](#)). Any change of configuration of the head and main packets when the dynamic archive is on can cause flash memory formatting and data loss. The use of dynamic archive can considerably increase the maximum number of stored points up to 58000.

By using the internal flash memory it is possible to choose the order in which points are sent to the server.

By default, the data are saved in the depth of the data store, i.e. current data are saved before older data. Transfer in chronological order can be set by FLASHARCHIVE command. After changing the direction of memorizing data the flash memory will be formatted and all previously stored data will be lost.

By using a micro-SD card, the data are always sent in chronological order. Note that only current data are used for the first packet.

Operation with two SIM-cards

The Terminal has 2 slots for installation of SIM-cards. Only one SIM-card can be active and support the registration in GSM/3G-network at the same time. Each SIM-card has its own APN. If a PIN code is used, it must be the same for both SIM-cards. The Terminal supports the following algorithm of SIM-card operation:

1. Only one SIM0 card is always active.
2. Automatic switching to the other card, if the data cannot be sent to the server within 9 minutes. Switching occurs in cycles, i.e. first SIM0 is used, then SIM1, and after this SIM0 again.
3. Switching between the SIM-cards according to the list of preferred GSM/3G-networks. If the Terminal detects the availability of one of the specified GSM/3G-networks, it switches to the corresponding SIM-card. If both networks specified for SIM0 and SIM1 are available at the same time, the preference will be given to SIM0.
4. Always only one SIM1 card is activated.
5. Always only SIM-microchip is activated.

The second algorithm is always used for remote firmware updating; the Terminal attempts to get the connection to the server with firmware through SIM 0, and if it fails - through SIM 1.

GPRS traffic costs optimization

GPRS-traffic costs decrease by online monitoring may be reached by following these advices:

1. Turn off the transmission of unused data, for example, temperature, acceleration, analog and digital inputs values which have no connected sensors. It can be made in the Configurator on Settings/Protocol tab or by MainPack and HeadPack commands (section [Server exchange protocol settings](#)).
2. Increase points record period. It can be made in the Configurator on Settings/Track tab or by WrPeriod command (section [Track parameters settings](#)).
3. Increase turning angle at which the device records a point, and distance at exceed of which the point is recorded. It can be made in the Configurator on Settings/Tracks tab or by Turning command (section [Track parameters settings](#)).
4. Find out the time of disconnection because of the Terminal inactiveness from the server software developers. This parameter should be taken into account by points' record period setting otherwise the traffic will increase because of costs for restoring connection to the server. Example: points' record period at a stop is 1200 seconds (20 minutes), the server disconnection because of the terminal inactiveness is 180 seconds (3 minutes). The Terminal determines that a vehicle has stopped and switches on a timer for the next point record in 20 minutes, in 3 minutes the server disconnects as it hasn't received the data from the Terminal. The Terminal tries to reconnect the server at once. It happens 6 times, and only in 20 minutes the Terminal sends the next point. As a result, traffic costs considerably exceed savings from points record interval increase.
5. Set filtering of coordinates at a stop so as the Terminal can correctly chose points' record period. The Terminal can determine a stop according to several elements:

- accelerometer data (AccSens command, section [Track parameters setting](#));
- external supply voltage (MHours command, section [Track parameters setting](#));
- ignition sensor indications (Ignition command, section [Track parameters setting](#)).

If continuous online monitoring is not necessary, it is possible to set packet data transmission (section [Stels mode and packet data transmission](#)). In this case, the device will periodically contact, send the data from the blackbox and disconnect from the server. Savings are due to decrease of costs for one data packet transmission as when sending data from the archive a packet size may be up to 1000 byte, and by online monitoring usually one point is sent (a few tens of bytes). At the same time, the Terminal operation from the battery increases as during server disconnection periods the device switches off GSM/3G-unit.

Operation in international roaming

The Terminal allows setting special parameters of data transmission in the international and national roaming (Roaming command, section [Data transmission settings](#)). After registration in GSM/3G-network the Terminal receives code of the country and code of the operator from base station and compares them with the set ones, if they do not match, the Terminal is in roaming. It is possible to specify only code of country (international roaming) or code of country and code of operator (national roaming). Being in roaming, the Terminal constantly supports registration in GSM/3G-network but initializes GPRS-session only according to the schedule, thus it is always possible to make a call to the terminal or send SMS with a command and decrease GPRS-traffic costs. For GPRS-session the maximum volume of transmitted data in bytes is determined. Each cellular operator has minimum tariffing interval in roaming, it is recommended to set maximum data volume equal to half of this interval (the second half is for official traffic TCP/IP, the volume of which depends on connection quality). By archive transmission from internal flash-memory, the Terminal always unloads according to the archive settings (FLASHARCHIVE command, section [Service commands](#)). By archive transmission from microSD-card it is recommended to set coordinates transmission and sensors indications in the first packet, thus the Terminal sends one point with a current vehicle coordinate and the oldest unloaded archive part. The data from the microSD-card are unloaded in chronological order.

Stels mode and packet transmission

In this mode the Terminal switches off GSM/3G-unit and contacts only according to a strict schedule, which allows decreasing the Internet traffic and power consumption.

Stels mode settings command: `stels pday,phours,minGSMon` where

- `pday` – Terminal contact is enabled once on `p` days since the beginning of the month, in other words on days, multiple to `pday`;
- `phours` –Terminal contact is enabled once at `p` hours since midnight GMT, in other words at hours, multiple to `phours`.
- `minGSMon` –GSM/3G-unit is enabled for `minGSMon` minutes since the beginning of the hour.

Packet transmission parameters can also be set in the Configurator on [Settings/Data transmission](#) tab.

To disable this mode use the `stels0,0,0` command.

Settings examples:

- 1) – contact once a day;
– contact at 14.00 GMT;
– staying in network for 15 minutes.

Setting command: stels 1,14,15

To enable the Terminal contact once a day hours must be greater than 11, i.e. it can be enabled at 11 and at 22 o'clock. If it is set to contact every 12 hours, the contact will be enabled at 12.00 and the next one must be at 24.00, but this is another day, i.e. it is not realized.

- 2) – **contact once a day;**
– contact every 2 hours GMT;
– staying in network for 15 minutes.

Setting command: stels 1,2,15

- 3) – **contact once in three days;**
– contact at 23.00 GMT;
– staying in network for 15 minutes.

Setting command: stels 3,23,15

Note.

- contact at 0 o'clock GMT cannot be enabled whatever the Terminal`s settings are;
- remote commands will work only when the Terminal radio silence mode is disabled, i.e. GSM/3G-unit is on;
- do not set the contact time less than five minutes, otherwise the Terminal will not have enough time to establish a link with the server and to report about its location.

Geofences

The Terminal allows setting areas where coordinates are not updated, the GSM/3G-unit is switched off. It is also possible to set periodical camera shooting (PhotoCfg command, section [Digital inputs settings](#)). Each area is described by the coordinates of the center and by the radius. Geofences' setting commands are given in section [Track parameters setting](#).

Power saving

To reduce power consumption of the Terminal in the operating mode, perform the following steps:

1. For RS232 port, execute RS2320 0 or specify "nothing" as the peripheral type in the Configurator.
2. Turn off the integrated CAN-controller if the Terminal is not connected to a CAN-bus. This can be performed by using CANREGIME command with the first parameter set to 0, or by specifying "CAN disabled" as the filter type in the Configurator.

3. Turn off the Autoinformer when it is not in use. This can be done by sending AUTOINFORMER command with the first parameter set to 0, or by unticking the Autoinformer section of the Configurator.
4. Reduce the degree of track details. The lower this degree, the less the power consumption.

To reduce power consumption of the Terminal at a stop, perform the following steps:

1. Set up the shutdown of the GPS/GLONASS unit at a stop, this can be performed by using SLEEPMODE command (section [Service commands](#)) or on the Power saving tab in the Configurator.
2. Enable the deep sleep mode at a stop. The deep sleep mode is turned on at the end of a pre-specified time period at a stop. In this mode the Terminal disables the specified modules (GPRS, CAN, RS232, RS485, microSD), reduces the ADC sampling rate, does not sample 1Wire sensors and does not charge the battery. The behaviour in the deep sleep mode can be configured by using SLEEPMODE command (section [Service commands](#)) or on the Power saving tab of the Configurator. It is possible to setup a period of connection to a server in the deep sleep mode.

Remote configuration

Remote configuration can be performed through several data transfer channels:

1. SMS. The Terminal has a list of 4 authorized phone numbers, the messages from which are treated as configuration commands. The available commands are described in the section [Settings for SMS control](#). A phone number can be added to the list of authorized numbers either through the Configurator, or by sending a message with AddPhone command (section [Settings for SMS control](#)).
2. GPRS. Commands can be sent from the monitoring data processing server. The format of the commands is described in the section [Galileosky protocol data](#).
3. GPRS. Commands can be sent via the Configurator and the remote configuration server of RSA "Galileosky", LLC. In this case, the Terminal supports two parallel connections: the first – with the monitoring data processing server, and the second – with the remote configuration server. Remote configuration can be enabled using RemoteConfig 1 command (section [Service commands](#)). It is possible to send commands to the Terminal, to receive current information from the sensors connected and to receive diagnostic messages, when working with the remote configuration server. Using the Configurator, it is possible to create a command pack to configure the Terminal and to save it on the server. These commands will be sent to the Terminal when it establishes the connection to the server.

Connecting External Peripheral

CAN-interface

The Terminal allows extracting information from the CAN-bus.

The following protocols are supported:

- J1939 (FMS). According to this protocol, the Terminal is not a device transmitting to CAN-bus, the device does not change vehicle operation, it also does not send confirmations to vehicle units packets and there is no electrical noise in the CAN-bus. In some cases, by connection to the troubleshooting socket for correct reading of information from the bus it is necessary to send confirmations to vehicle units packets, for this give ActiveCAN 1 command to the Terminal (section [CAN settings](#)).
- J1979 (OBD II). This protocol works according to the question-answer mode, consequently, the Terminal issues requests to the CAN-bus.

Available performance modes:

J1939_SCANNER – the bus scanner sending bus reports to the configurator.

FMS – a standard FMS protocol filter. (see www.bus-fms-standard.com).

J1939_USER_29bit – a configurable user filter. Identifier length is 29 bits.

J1939_USER_11bit – a configurable user filter. Identifier length is 11 bits.

J19379_SCANNER – the bus scanner defining bus speed and identifier capacity.

J1979_29bit – a standard J1979 protocol filter for 29 bits identifiers.

J1979_11bit – a standard J1979 protocol filter for 11 bits identifiers.

J1939_SCANNER mode

This mode is intended to study CAN-bus reports, according to J1939 protocol.

Bit rates from 10000 bit/s up to 500000 bit/s (typical values: 62500, 12500, 250000, 500000) are supported.

11 and 29 bit identifiers are supported.

The scanning mode works as follows:

1. The **CAN. Start scan.** message is displayed;
2. The CAN-bus reports are displayed with a delay indicated by the CAN Regime command. (section [CAN settings](#)).

29bit identifiers are displayed in the following format:

ID= 00000009 (8) 06 07 08 09 00 CC DD EE

Where:

ID - is a 29bit message identifier;

(8) - is the number of received bus bytes.

06 07 08 09 00 CC DD FF - is an 8byte message. (The lower byte is on the left, the higher byte is on the right),

11bit identifiers are displayed as

ID=009 (8) 06 07 08 09 00 CC DD EE

User Manual Galileosky 5.1

Where:

ID - is an 11 bit message identifier;

(8) - is the number of received bus bytes;

06 07 08 09 00 CC DD EE is an 8byte message. (The lower byte on the left, the higher byte on the right).

3. After all the identifiers have been displayed, you can see the **CAN. End scan** message.

To enable this mode:

- 1) connect the Terminal to the vehicle CAN-interface;
- 2) in the Configurator on Settings/CAN tab select bus rate and delay time (time of message waiting time);
- 3) press Start Scanning J1939. Received data are displayed in the right panel.

FMS mode

This mode is activated in all Terminals by default; it allows retrieving and decoding messages relevant to FMS protocol:

- total fuel consumption: the amount of fuel the vehicle had used since it was made;
- tank fuel level: measured in percent. 0%-empty, 100%- full;
- coolant temperature;
- engine speed;
- total mileage;
- operating hours;
- axis load.

ATTENTION! Many car manufacturers support FMS protocol partially or do not support it at all.

To enable this mode:

- 1) connect the Terminal to the vehicle's CAN-interface;
- 2) give the CanRegime 2,250000,2000 command (section [CAN settings](#)) or select FMS filter type in the Configurator on Settings/CAN tab;
- 3) make sure that the device receives bus data and sends them to Device tab in the Configurator;
- 4) set data transmission to the server using the MainPack command (section [Server exchange protocol settings](#)) or in the Configurator on Settings/Protocol tab.

J1939_USER_29bit mode

This mode enables us to receive 29bit identifiers messages from the vehicle CAN-bus, according to J1939 protocol.

To enable this mode:

- 1) connect the Terminal to the vehicle's CAN-interface;
- 2) select Custom filter (29bit identifiers) type in the Configurator on Settings/CAN tab, set the bus rate and delay time or give CanRegime command with necessary parameters (section [CAN settings](#));
- 3) set filters for CAN-bus messages.

- 4) set sending of received data to the server with the help of MainPack command (section [Server exchange protocol settings](#)) or in the Configurator on Settings/Protocol tab.

Notes:

- 1) In protocol of the first and the main packet of the Terminal there are 1-byte, 2-bytes and 4-bytes tags for this mode operation, i.e. if the necessary ID needs only one byte from all data, better choose 1-byte tag.
- 2) Any of these tags can correspond to the right CAN message ID

ATTENTION! The data should be recorded in the decimal system in the Terminal. The hexadecimal notation is used for convenience only.

By means of shifting it is possible to choose exactly that part of bytes, which should be filled in the tag from the useful information received with this ID.

Let us consider an example:

The CAN message identifier is ID=0x18F00300.

We need only the first byte of all the sent content with this ID.

As we need only one byte, we shall choose the tag CAN_R0 as an example.

The command to set the tag is as follows: CAN8BITRO ID,Shift

- 1) The tag number ID=0x18FEEEE0 will look as 419360256 in the decimal system.
- 2) The byte we need is shifted by one byte that is the second parameter is equal to 1.

So we have the following filter settings: CANBITRO 419360256, 1.

Now when this message is passing through the bus, the first effective load byte will automatically be placed to the tag R0 and sent to the server.

These settings are easier to make in the Configurator:

1. Scan the bus;
2. Indicate identifier in the first column;
3. Select the correspondent tag;
4. Visually indicate the shift using a mouse. The number, transmitted to the server, will be displayed in the Value column.

J1939_USER-11bit mode is set similarly.

J1979_SCANNER mode

This mode is used to define data transfer rate and Identifier length according to J1979 protocol. If the parameters of transfer are known, it is recommended to use the J1979_29bit and J1979_11bit modes, having specified the necessary rate of the bus.

The rate of 250000 bits per second and 500000 bits per second and 11 and 29 bit identifiers are supported.

To enable this mode:

User Manual Galileosky 5.1

- 1) connect the Terminal to the vehicle's CAN-interface;
- 2) press "Test OBD II". Received data are displayed in the right panel.
- 3) if scanning is finished successfully, data transfer rate and Identifier length will be set automatically.

ATTENTION! Scanning can cause failures in on-board equipment operation. Galileosky Ltd bears no responsibility for any failures after CAN-bus scanning.

J1979_29bit mode

This mode allows extracting and decoding the messages with 29 bit identifiers, transferred according to J1979 protocol automatically:

- tank fuel level: measured in percent. 0%-empty, 100%- full;
- coolant temperature;
- engine speed;
- errors codes.

ATTENTION! Many car manufacturers support J1979 partially or do not support it at all.

To enable this mode:

- 1) connect the Terminal to the vehicle's CAN-interface;
- 2) give the CanRegime command (section [CAN settings](#)) or select OBD II 29bit filter type in the Configurator on Settings/CAN tab;
- 3) make sure the device receives bus data and sends them to Device tab in the Configurator;
- 4) set the received data transmission to the server using the MainPack command (section [Server exchange protocol settings](#)) or in the Configurator on Settings/Protocol tab.

J1979_11bit mode is set in a similar way.

ATTENTION! If your vehicle doesn't support J1939 protocol, J1979_29bit and J1979_11bit modes operation can cause failures of board equipment operation. RSA "GALILEOSKY", LLC bears no responsibility for failures after activation of these modes.

Different variants of connection to the CAN-bus

1. Direct connection.

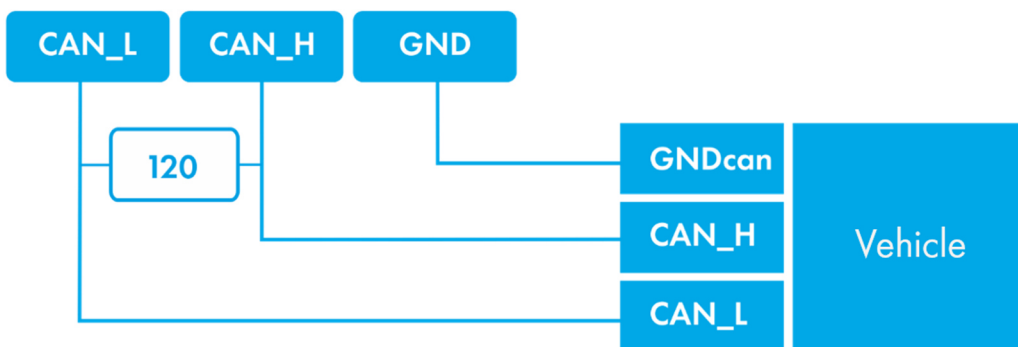

ATTENTION! If the terminating resistor (is shown with a dotted line in the diagram) is not installed on the vehicle side, it should be installed. Its presence can be checked with the help of a multimeter: it is necessary to measure the resistance between CAN_H and CAN_L when the vehicle electronics is off. If the resistance is about 60 Ohm, there is no need for a terminating resistor. If the resistance is 120 Ohm, it is necessary to connect a standard 120 Ohm resistor between the CAN_H and CAN_L wires.

2. Connection with current-limiting resistors

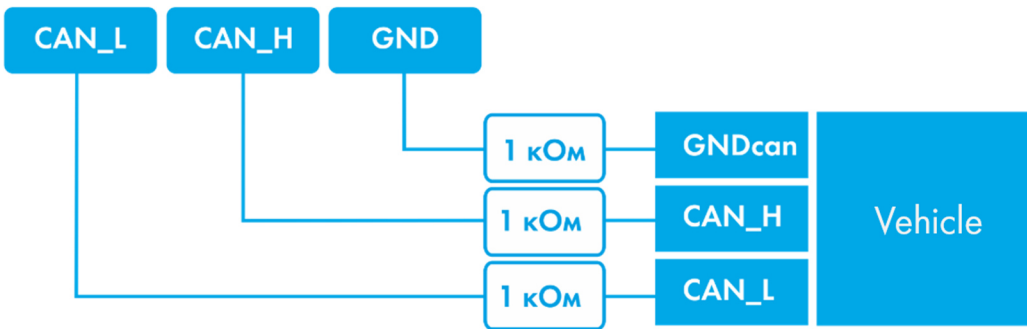

To plug the Terminal into the troubleshooting socket it is necessary to use the first connection variant.

The second variant is recommended only for use to connect the Terminal directly to the vehicle's CAN-bus.

Connecting digital fuel sensors using RS232 protocol

The order of connection:

1. Connect RXD, TXD and GND sensor contacts to Terminal TXD0, RTD0 and GND contacts (section [Contacts description](#)).

ATTENTION! The Terminal and sensor grounds must be connected!

The sensor power supply is provided separately.



2. Set for the RS232 Terminal channel an option to receive relative fuel level or frequency from the sensor. It can be done by sending RS2320 command (section [Digital inputs settings](#)) or through the Configurator on Settings/Digital inputs tab. RS232 Terminal channel is set to receive relative fuel level by default.

3. If you need to filter bursts of fuel, adjust filter length by DFILTER command (section [Digital inputs settings](#)) or in the Configurator on Settings/Digital inputs tab. Temperature is saved only by archive dynamic structure activation (FlashArchive command, section [Service commands](#)).
4. Set transfer of received data to the server by MAINPACK command (section [Server exchange protocol settings](#)) or in the Configurator on Settings/Protocol tab. These data transmission is on by default.
5. Make sure that the Terminal receives data from the sensor. It may be done in the Configurator on Device tab.

If the Terminal receives no messages from the sensor for 18 seconds, the RS232 field value will come to zero. In this way, it is possible to detect sensor disconnection or failure.

Connecting digital fuel sensors using RS485 protocol

The order of connection:

1. Connect RS485_A; RS485_B, GND sensor contacts to Terminal RS485_A; RS485_B, and GND contacts (section [Contacts description](#)).

The sensor power supply is provided separately.

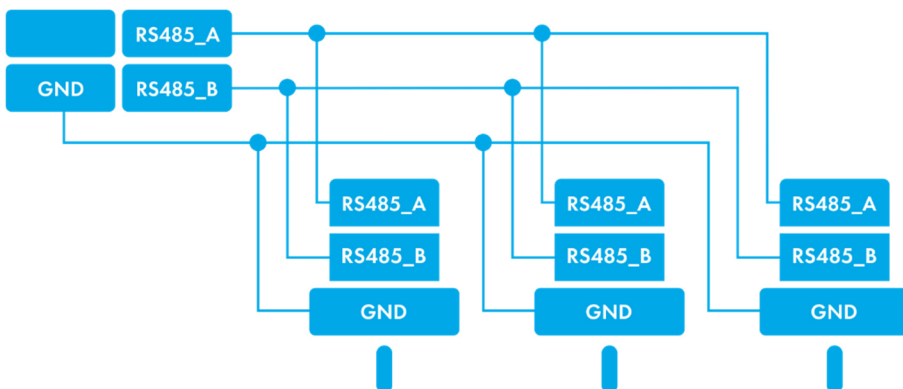

2. Set transfer of received data to the server by MAINPACK command (section [Server exchange protocol settings](#)) or in the Configurator on Settings/Protocol tab. These data transmission is on by default.
3. Make sure that the Terminal receives data from the sensor. It can be done in the Configurator on Device tab.

The Terminal can support up to 16 sensors at a time. The sensors should have addresses from 0 to 15 correspondingly. If the Terminal receives no messages from the sensor for 18 seconds, the RS485 field value will be set to zero. In this way, it is possible to detect sensor disconnection or failure. Values from sensors with the addresses from 4 to 15 and temperature data from sensors with the addresses from 0 to 15 are stored in the memory only by archive dynamic structure activation (FlashArchive command, section [Service commands](#)).

Connecting Galileosky photo camera to the device

Galileosky v3.0.0 no enclosure protection

Galileosky v3.0.3 and v3.1.0 hermetically-sealed



Data transmission interface: RS232

Data transmission interface: RS232 or RS485

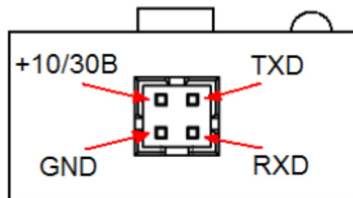

Wires (RS232):

1. Brown: +10/30V
2. Black: GND
3. Blue: TXD
4. White: RXD

Wires (RS485):

1. Brown: +10/30V
2. Black: GND
3. Blue: RS485_A
4. White: RS485_B

Dimensions: 45,0 x 30,0 x 15,0 mm.

Dimensions: 54,0 x 38,0 x 21,0 mm

Camera technical specifications:

- Power supply: 10-30V;
- Average power consumption in standby mode: 0.17W;
- Average power consumption in shooting mode: 0.53W;
- Operating temperature range: -30...+60°C;
- Body material: plastic;
- Turn on time: less than 2sec;
- Camera mode announcement.

User Manual Galileosky 5.1

Optical characteristics:

- Focal distance: 4mm;
- Angle of view: 64 degrees;
- Distortion: 0, 38%;
- Infrared filter: yes;
- Manual focusing: yes;
- Matrix diagonal: ¼”.

Picture characteristics:

- Color depth: 24bit;
- Picture format: JPEG;
- Picture resolution: 640x480 or 320x240 dots;
- Picture size: 6-65kB;
- Average picture size: 25kB;
- Time of one picture receiving: 2-10 s;
- Time of transmission to the server: more than 1 minute (depends on the picture size and GSM connection quality).

The order of connection cameras via RS232 interface:

1. The camera RXD, TXD, GND contacts should be connected to the device TXD0, RXD0, GND contacts (section [Contacts description](#)).

ATTENTION! The Terminal and the camera grounds should be connected!

Camera has separate power supply.

2. Insert a microSD card into the Terminal slot.
3. Make the right settings of RS232 Terminal port for operation with camera, you can use RS2320 command (section [Digital inputs settings](#)), or it can be done in the Configurator on Settings\Digital inputs tab.
4. Make sure that the Terminal operates with camera correctly, in the Configurator give makephoto 1 command and switching to the Troubleshooting tab tick RS232 and RS232 detailed. When the terminal receives a picture from the camera, there will be “RS232[0].cam. rx pic” message displayed. Green LED on the camera blinks rarely in standby mode and quickly during picture transfer.
5. Evaluate the quality of the picture in the configurator, or eject the microSD card from the Terminal and connect it to PC. Pictures from the camera connected to RS232 port are saved in the catalogue Pic\RS0. A separate catalogue is created for each date, file names reflect the time when the shots were taken.
6. Reinsert the microSD card.

The order of connection cameras via RS485 interface:

1. Connect the RS485_A, RS485_B, GND camera contacts and the RS485_A, RS485_B, GND Terminal contacts correspondingly (section [Contacts description](#)).

ATTENTION! The Terminal and the camera grounds should be connected!

Camera has separate power supply.

2. Insert a microSD card into the Terminal slot.
3. Make the right settings of RS485 Terminal port for operation with cameras and fuel sensors, use RS485FN command (section [Digital inputs settings](#)) or the Configurator on Settings\Digital inputs tab.
4. Reset the Terminal.
5. Make sure that the Terminal operates correctly with the camera. For this, give the makephoto 2 command in the Configurator and, after switching to the Troubleshooting tab, tick RS485. When the Terminal receives a picture from the camera, the Troubleshooting will display RS485[0].cam. rx pic. message. Green LED on the camera blinks rarely in standby mode and quickly during picture transfer.
6. Evaluate the quality of the picture in the Configurator, or eject the microSD card from the Terminal and connect it to PC. Pictures from the camera are saved in the catalogue Pic\RS4850. A separate catalogue is created for each date; file names reflect the time when the shots were taken.
7. Reinsert the microSD card.

Connecting 1Wire sensors

It is possible to connect different sensors working through 1-Wire interface, and they can operate simultaneously.

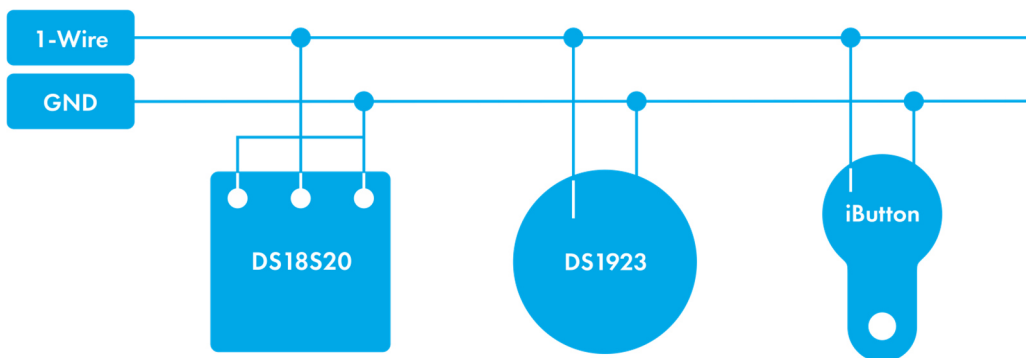

Connecting iButton (DS1990, DS1982) identification key

There are several identification key applications:

- driver identification;
- trailer detachment identification;
- doors opening identification.

In the same way, it is possible to connect devices emulating iButton, for example, RFID-codes readers.

The Terminal can support up to 8 identification keys with certain identifiers or two identification keys with any identifier. When using a microSD card up to 1000 IK with certain identifier are supported.

By identification key applying to 1-Wire and GND contacts ([Contacts description](#)) the key number is entered into the memory, the point is recorded and four lower bytes are sent to the server without checksum. By key disconnection the number turns to zero, the point is recorded and message is sent to the server. Keys having code less than 100000 are stored in iButton[1] field. By iButton detachment from the Terminal, key value is set to zero in the memory cell in 4

seconds, message with the zero code is transmitted to the server. For keys with the code less than 100000, timeout from detachment to setting to zero of the memory cell is 25 minutes. Timeout for setting to zero can be set by IBCFG command (section [Digital inputs setting](#)) or in the Configurator on «Settings»\«Digital inputs» tab.

Eight key identifiers can be set using iButtons command (section [Digital inputs setting](#)) or in the Configurator on Settings\Digital inputs tab. You should enter 4 lower bytes of iButton key number without checksum, in hexadecimal system.

For example, full key hexadecimal number:

09 91 02 0C 00 00 00 5C, where

09 – type of device (in this case, it is DS1982, for DS1990 – 01),

91 02 0C 00 00 00– unique number,

5C – the checksum.

In this case, 91 02 0C 00 must be entered.

By identification key applying with one of the certain identifiers, a correspondent bit will be set in iButton connection status field. You may control it on the Device tab in the Configurator.

By using a microSD card you may edit a list of trusted keys with the help of the AddKey, DelKey commands (section [Digital inputs settings](#)). You can also connect the card to the computer and edit the list in the Configurator on the Trusted iButton keys tab. In case of connection of one of the enlisted IK, a correspondent bit will be set in the Device Status field.

Connecting DS18S20 (DS1820, DS18B20) thermometers and DS1923 temperature and humidity sensors

It is possible to connect up to 8 DS18S20 thermometers and 8 DS1923 sensors. To use the sensors connect them to 1-Wire and GND contacts ([Contacts description](#)) and activate the corresponding protocol items ([Server exchange protocol settings](#)). There is no any linkage between a thermometer or humidity sensor and a certain tag cell in the protocol. All data are stored in memory cells in a definite order: from a lower tag to a higher tag. If the number of cells exceeds the number of thermometers of one type, the extra higher cells will contain the data which correspond to disconnected sensor state.

By temperature sensor turning off the thermometer field shows disconnection (-128°C).

By humidity sensor turning off the humidity field shows disconnection (0%).

Connecting Autoformer speaker



Connecting audio equipment

A CMS-25 push-to-talk button or another compatible one can be connected directly to the Terminal.

For working with push-to-talk, it is needed to run tangenta 1 command or to set this parameter in Configurator. If you are using push-to-talk at the moment of incoming call, you may answer by pressing a push-to-talk button shortly.

A speaker and a microphone can be connected separately for the terminals of modification 21. The speaker may have Jack 2,5 Stereo or Jack 2,5 Mono connector. The microphone should have Jack 3,5 Stereo connector.

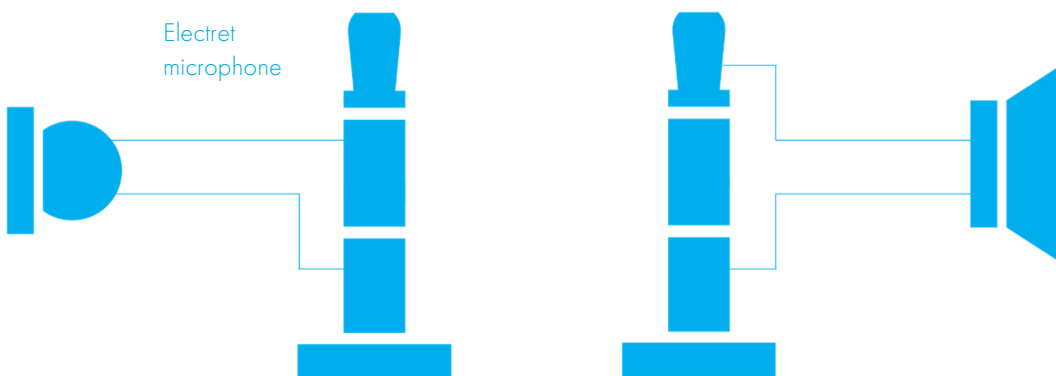

Microphone specifications

Parameter	Minimum value	Mean value	Maximum value
Operating voltage, V	-	1.60	2.2
Operating current, uA	70	-	300
Load resistance, kOhm	1.2	2.2	-

Speaker specifications

Parameter	Minimum value	Mean value	Maximum value
Connected speaker resistance, Ohm	8	-	-
Operating current, mA	-	-	+250
Power with a 32Ohm speaker, mW	-	250	-

Transistor outputs (0/1)

To operate external devices there are 4 discrete «open collector» outputs (section [Contacts description](#)) in the Terminal. The maximum output voltage is +30V, each output current is no more than 80mA.

The Terminal outputs values are stored in the nonvolatile memory, so the device sets these stored values even after being reset.

To operate outputs use Out command (section [Transistor outputs settings](#)) or the Settings/Inputs/Outputs tab in the Configurator.

OUT0...OUT3 outputs relay connection circuit

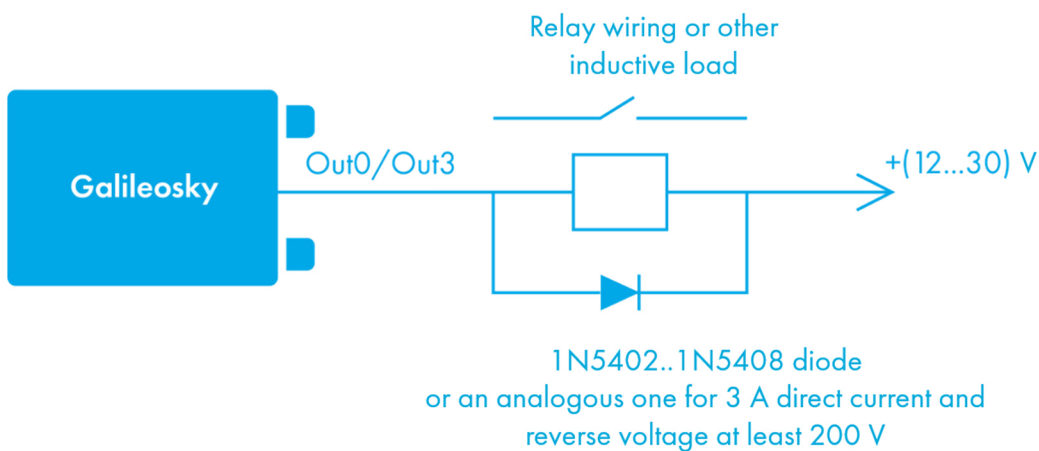

Connecting passenger flow registration SH2 sensors

The Terminal supports connection of up to 16 SH2 sensors through 8 discrete-analog inputs (DAI) IN0-IN7 ([Contacts description](#)).

Connection order of one SH2 sensor through resistor to one of DAI of the Terminal.

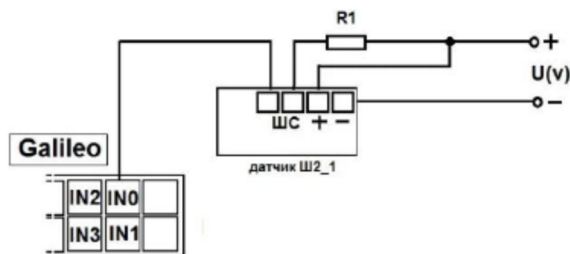

To connect 2 SH2 sensors to one of DAI use divisor on two resistors. Calculation principle is realized on voltage level change by sensors triggering.

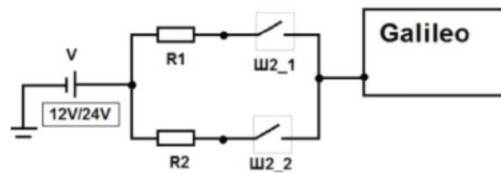

V – Power supply (battery/ vehicle power supply);

R1, R2 – resistors;

SH2_1, SH2_2 – SH2 passenger flow registration sensors.

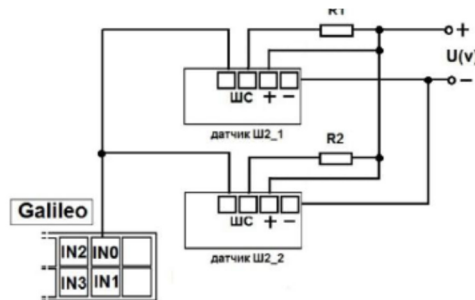

Connection order of 2 SH2 sensors through resistors to one of DAI of the Terminal.

To set an input to count pulses from two sensors one may in the Configurator or by `incfg0 3,2,X,X,Y,Y` command (where Y – one sensor triggered; X – two sensors triggered).

Parameter X and Y depending on supply voltage and R1, R2 resistors resistance assumes different values, for example:

$$U(v)=12, R1=10k, R2=10k, \text{ then } X=3500, Y=7921$$

$$U(v)=12, R1=14k, R2=14k, \text{ then } X=3000, Y=7000$$

$$U(v)=24, R1=10k, R2=10k, \text{ then } X=7000, Y=15842$$

$$U(v)=24, R1=14k, R2=14k, \text{ then } X=6000, Y=14000$$

It is calculated according to the formula:

$$X = \left(\frac{7 * U}{14 + R1 * 0.001} \right) * 1000; \quad Y = \left(\frac{14 * U}{28 + R1 * 0.001} + \frac{7}{14 + R1 * 0.001} \right) * 1000;$$

ATTENTION! To avoid false operation by sensors connection and further operation of sensors, use stable voltage power supply.

Terminal operation result will be pulse fronts count from each sensor, i.e. when one person passes through one door, total pulse number increases by 2. Correspondingly, to count passengers number passed through the sensors divide pulse count result by 2.

Connecting Garmin navigators supporting FMI protocol

The Terminal can serve as a gateway for Garmin FMI protocol packets transmission to the server and back. Garmin FMI protocol enables:

- drivers identification by code numbers (driver enters his/her number into a navigator, the number is transmitted to the server);
- driver status transmission to the server (driver selects his/her status on a navigator display);
- text messages exchange between Garmin navigator and the server;
- transmission of route end points from the server to the navigator (in this case, the navigator calculates optimal path to the set points and displays it on the map);
- control for speeding and informing the server about it;
- geofences transmission from the server to the navigator and displaying them.

A description of protocol abilities can be found on <http://www8.garmin.com/solutions/pnd>

The Terminal only transmits the packets from the navigator to the server and back, so parsing the packets should be done at the server.

To connect Garmin navigator:

1. Purchase an interface Garmin FMI cable (for example, Garmin FMI 10), cable is to be chosen according to the navigator model. The cable has a mini-USB socket to connect to the navigator at one end, and supply and RS232 interface contacts at another end.
2. Connect RS232 interface contacts to the Terminal RS232 zero port; connect RX contact of the cable to the TXD contact of the Terminal; TX contact of the cable to the RXD contact of the Terminal; be sure to connect GND RS232 contact of the cable to the GND contact of the Terminal.
3. Connect cable power supply.
4. Connect the cable to the navigator.
5. Configure RS232 port in the Terminal to work with the navigator. It can be done by RS2320 5 command or in the Configurator on Settings\Digital inputs tab.

To make sure that the Terminal and the navigator connection works properly select messages from necessary RS232 port in troubleshooting. If the connection is correct, the following messages will be displayed regularly:

RS2320. Garmin FMI. Enable FMI.

RS2320. Garmin FMI. ACK.

If the connection is right, the navigator interface will change, the left-hand icon will take the form of a truck, it will give an access to messages sending and receiving functions.

Connecting REP-500 electrical meter

The REP-500 is an electrical meter, which can be connected to the Terminal via RS232 interface. To connect the REP-500, perform the following steps:

1. Connect RXD, GND contacts of the Terminal to TX, Ground contacts of the REP-500 correspondingly.
2. Configure the RS232 port in the Terminal for operation with the meter. This can be performed using the RS2320 10 command or in the Configurator on the Settings\Digital inputs tab.
3. Set the meter readings transfer to the server with the help of MainPackBit 171,1 command.

Connecting CAN-LOG

The CAN-LOG device is designed for CAN-bus data reading. It allows getting the data about:

- total time of engine operation;
- total mileage of a vehicle;
- whole fuel consumption of a vehicle since the date of the vehicle`s creation;
- fuel level in % or liters;
- engine speed;
- coolant temperature;
- vehicle speed;
- axle load.

The following prefixes are deciphered automatically: A, B, C, D, E, F, G, R, H, I, J, K, L, M, N, O, S, P, WA.

If the Terminal detected one of known prefixes, the following decipher stops. Thus, its value will not be in the list of user prefixes.

The CAN-LOG support was added to secure compatibility with the installed board equipment. By initial installation it is recommended to use the device built-in functions for CAN-bus operation (section [CAN-interface](#)). Advantages of using built-in functions of the device:

- no extra costs;
- a possibility to scan the CAN-bus;
- a possibility to read all CAN-bus data, and not just those listed for the CAN-LOG.

To connect the CAN-LOG you have to:

1. Connect RXD, TXD, GND contacts of the Terminal and RS232 TX, RS232 RX, CAN-LOG`s mass correspondingly.
2. Configure RS232 port in the Terminal for operation with CAN-LOG. It can be done by RS2320 6 command or in the Configurator on Settings\Digital inputs tab.
3. Disconnect the Terminal built-in functions for operation with CAN-bus. It can be done by CANREGIME 0,250000,2000 command or in the Configurator on Settings\CAN tab .
4. Specify the parameters transferred to the server. HEADPACK OR MAINPACK commands can also be used (section [Server exchange protocol settings](#)) or in the Configurator on Settings/Track tab.

Connecting CUB5B indicator

The CUB5B indicator is a segment 8-bit indicator, which can be connected to the Terminal using RS232 interface. It can display current sensors data, CAN-bus data, mileage and so on. Information updates every second.

Connection:

1. If the indicator was set to operate with other equipment, it is necessary to reset to factory settings. If the indicator is new, it is unnecessary.
2. Connect RXD, TXD, GND Terminal contacts and TX, RX and Ground contacts of the CUB5B correspondingly.

3. Configure RS232 port in the Terminal for operation with indicator, it can be done by RS2320 7 command or in the Configurator on Settings\Digital inputs tab.
4. Choose the displayed parameter, it can be done by CUB5 command or in the Configurator on Settings\Digital inputs tab.

Connecting CI5010A weight indicator

The CI-5010A weight indicator is designed to measure, control and indicate electrical signals produced by weight measuring strain gages sensors. It can be connected to the Terminal via RS232 interface.

The order of CI-5010A connection:

1. Adjust the indicator to output the measured value constantly.
2. Connect RXD, TXD, GND contacts of the Terminal and TX, RX, Ground of CI-5010A correspondingly.
3. Configure the RS232 port in the Terminal to operate with the indicator. It can be done by the RS2320 12 command or in the Configurator on Settings\Digital inputs tab.
4. Set «RS232» tag for sending to the server;
5. If possible, measured weight exceeds the interval [0, 65535], turn on the dynamic archive and set «Extended RS232 data» tag sending.

The data from the indicator are rounded up to a whole number. Measured weight is transmitted in two tags: «RS232» and «Extended RS232 data». If measured weight is within the interval from 0 to 65535 kg, it is transmitted only in «RS232» tag, weight is calculated in a different manner according to a formula «RS232»+65535x«Extended RS232 data». Signed number is transmitted in «Extended RS232 data» tag, thus, it is possible to receive both positive and negative weight.

Connecting Tenzo-M weight indicator

The Tenzo-M weight indicator is designed to measure, control and indicate electrical signals produced by weight measuring strain gages sensors. It can be connected to the Terminal via RS232 interface.

The order of Tenzo-M connection:

1. Adjust the indicator to output the measured value constantly. Port speed is 2400 bit/s.
2. Connect RXD, TXD, GND contacts of the Terminal and TX, RX, Ground of Tenzo-M correspondingly.
3. Configure the RS232 port in the Terminal to operate with the indicator. It can be done by the RS2320 16 command or in the Configurator on Settings\Digital inputs tab.
4. Set «RS232» tag for sending to the server;
5. If possible measured weight exceeds the interval [0, 65535], turn on the dynamic archive and set «Extended RS232 data» tag sending.

The data from the indicator are rounded up to a whole number. Measured weight is transmitted in two tags: «RS232» and «Extended RS232 data». If measured weight is within the interval from 0 to 65535 kg, it is transmitted only in «RS232» tag, weight is calculated in a different manner according to a formula «RS232»+65535x«Extended RS232 data». Signed number is

transmitted in «Extended RS232 data» tag, thus, it is possible to receive both positive and negative weight.

Connecting AWT 640 weight indicator

The AWT 640 weight indicator is designed to measure, control and indicate electrical signals produced by weight measuring strain gages sensors. It can be connected to the Terminal via RS232 interface.

The order of AWT 640 connection:

1. Adjust the indicator to output the measured value constantly. Port speed is 9600 bit/s.
2. Connect RXD, TXD, GND contacts of the Terminal and TX, RX, Ground of AWT 640 correspondingly.
3. Configure the RS232 port in the Terminal to operate with the indicator. It can be done by the RS2320 16 command or in the Configurator on Settings\Digital inputs tab.
4. Set «RS232» tag for sending to the server;
5. If possible, measured weight exceeds the interval [0, 65535], turn on the dynamic archive and set «Extended RS232 data» tag sending.

The data from the indicator are rounded up to a whole number. By receiving the message about the changed weight from the indicator, the Terminal records a point and sends it to the server. Measured weight is transmitted in two tags: «RS232» and «Extended RS232 data». If measured weight is within the interval from 0 to 65535 kg, it is transmitted only in «RS232» tag, weight is calculated in a different manner according to a formula «RS232»+65535 «Extended RS232 data». Signed number is transmitted in «Extended RS232 data» tag, thus, it is possible to receive both positive and negative weight.

Connecting WIN SCALE weight indicator

The Dinamica Generale S.p.A. WIN SCALE weight indicator is designed to measure, control and indicate electrical signals produced by weight measuring strain gages sensors. It can be connected to the Terminal via RS232 interface.

The order of WIN SCALE connection:

1. Adjust the indicator to output the measured value constantly. Port speed is 9600 bit/s.
2. Connect RXD, TXD, GND contacts of the Terminal and TX, RX, Ground of WIN SCALE correspondingly.
3. Configure the RS232 port in the Terminal to operate with the indicator. It can be done by the RS2320 19 command or in the Configurator on Settings\Digital inputs tab.

The data from the indicator are rounded up to a whole number. By receiving the message about the changed weight from the indicator, the Terminal records a point and sends it to the server. If measured weight is within the interval from 0 to 65535 kg, it is transmitted only in «RS232» tag, weight is calculated in a different manner according to a formula «RS232»+65535×«Extended RS232 data». Signed number is transmitted in «Extended RS232 data» tag, thus, it is possible to receive both positive and negative weight.

Connecting Matrix 5 RFID-codes reader using RS485 interface

The order of Matrix5 connection:

1. Connect the RS485A, RS485B, GND contacts of the Terminal and the RS485A, RS485B, GND of the Matrix5 correspondingly.
2. Configure the RS485 port in the Terminal to operate with the reader. It can be done by the RS485FN 1 command or in the Configurator on Settings\Digital inputs tab.
3. Reset the Terminal.

The keys received from Matrix5 are stored in iButton[1] field.

Connecting DBG-S11D dosimeter using RS485 interface

DBG-S11D dosimeter is intended for continuous measuring ambient equivalent dose rate (ADER). The Terminal enables to receive the current ADER readings in 3V/h and data about dosimeter state. Then this information will be sent to the server. One dosimeter operation is supported. The dosimeter can be connected simultaneously with fuel sensors and Galileosky photo camera.

The order of DBG-S11D dosimeter connection:

1. Connect the RS485A, RS485B, GND contacts of the Terminal and the RS485A (contact 1), RS485B (contacts 2), GND (contact 6) of the dosimeter correspondingly. Dosimeter has separate power supply.
2. Configure the RS485 port in the Terminal to operate with fuel sensors, photo cameras and dosimeter. It can be done by the RS485FN 2 command or in the Configurator on Settings\Digital inputs tab.
3. Specify dosimeter data in the transmission protocol to the server. If dosimeter data sending is off, the Terminal will not sample DBG-S11D.
4. Turn on the Terminal`s archive dynamic structure. Dosimeter data are not stored in the archive by using the static structure.
5. Reset the Terminal.

Connecting PressurePro tires pressure monitoring system

PressurePro tires pressure monitoring system enables to carry out continuous control of pressure in tires and tire temperature and warns about critical situations. The system consists of wireless pressure sensors, installed on tires, and monitor, receiving data from sensors. The Terminal connects to PressurePro monitor via RS232 interface and receives data about sensors state and measured parameters.

Connecting PressurePro:

1. Connect RXD, TXD, GND contacts of the Terminal and TXD (white), RXD (green), GND (black) contacts of monitor correspondingly. Monitor has separate power supply.

2. Configure the RS232 port in the Terminal to operate with PressurePro. It can be performed by the RS2320 13 command or in the Configurator on Settings\Digital inputs tab.
3. Specify PressurePro data in the transmission protocol to the server.
4. Turn on the dynamic structure of the Terminal`s archive. PressurePro data are not stored in the archive by using the static structure.

By default, PressurePro sensors transmit data once in 5 minutes or by emergency arising (tripping sensors, pressure reduction and etc.). The Terminal transmits PressurePro data to the server by analogy: once in 5 minutes or by emergency arising, data are not transmitted at passing points to save GPRS-traffic. Operation of up to 34 sensors is supported.

Connecting CarrierDataCOLD500, ThermoKing, Euroscan refrigeration units temperature recorders

Temperature recorders allow transmitting the information about the refrigerator state to the Terminal, which, in its turn, sends to the server the following transformed data:

1. Operation mode of refrigeration unit;
2. Cargo temperature (for one- and multi temperature units);
3. Alarm signals;
4. Total time of engine operation.

Connecting a temperature recorder:

1. Connect RXD, TXD, GND contacts of the Terminal and TXD, RXD, GND contacts of temperature recorder correspondingly. Temperature recorder has separate power supply.
2. Configure the RS232 port in the Terminal to operate with one of temperature recorder types. It can be performed by the RS2320 command (DATA COLD500: RS2320 11, ThermoKing: RS2320 14, EuroScan: RS2320 15) or in the Configurator on Settings\Digital inputs tab.
3. Specify temperature recorder data in the transmission protocol to the server.
4. Turn on the dynamic structure of the Terminal`s archive. Temperature recorder data are not stored in the archive by using the static structure.

Configurator

Configurator is a PC program, which allows:

- configuring the Terminal via graphic interface and with the help of commands;
- troubleshooting the Terminal saving the results in a log-file;
- seeing the Terminal units state in real time mode;
- downloading monitoring data from the internal memory and a SD card;
- sending the downloaded data to the server;
- specifying areas for autoinformer.

32 and 64 bit OS are supported in OS Windows 7 with installed Service Pack 1 (SP1) or higher versions.

Program installation and running

Download the Configurator software from the [site](#) and launch it.

ATTENTION! Program installation may require changes of crucial OS elements. Do not let your antivirus program block the installer operation.

In case of a security system warning, confirm launching the program.

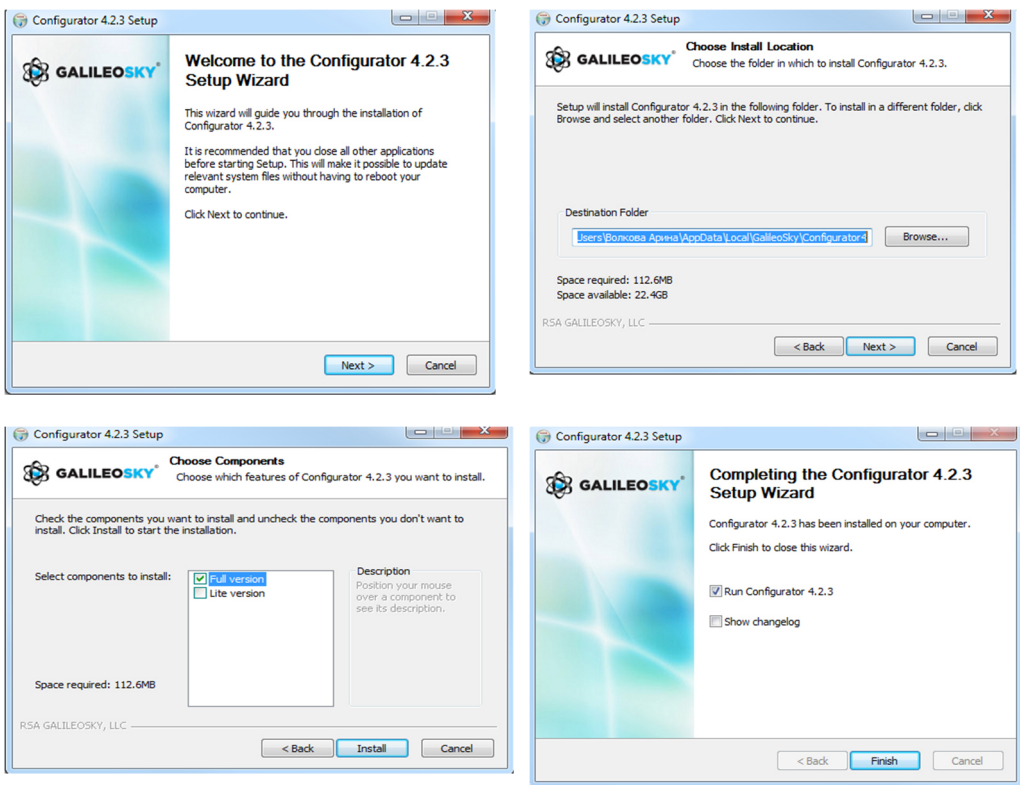

During the installation of the Configurator old drivers will be deleted and new ones will be installed. It is possible to install the major version of the Configurator or a limited one. The latter one allows uploading archive and receiving the current parameters of sensors, but not changing the settings.

User Manual Galileosky 5.1

Start the Configurator software (from Start menu\Programs\Galileosky\Configurator). Turn on the power of the Terminal and connect it to the computer via a USB-cable.

After the Terminal connection the program loads all the Terminal`s settings parameters automatically. If the program identifies the Terminal, all the buttons on the vertical left-hand panel will be active.

Device tab

The tab displays the information about the Terminal state and allows its resetting. This tab contains the Terminal model, oriented in space according to accelerometer indications. The model can be rotated by mouse. Parameter values, which are beyond the limits, wrong coordinates, exceeding of maximum incline angle and responses on inputs are shown in red.

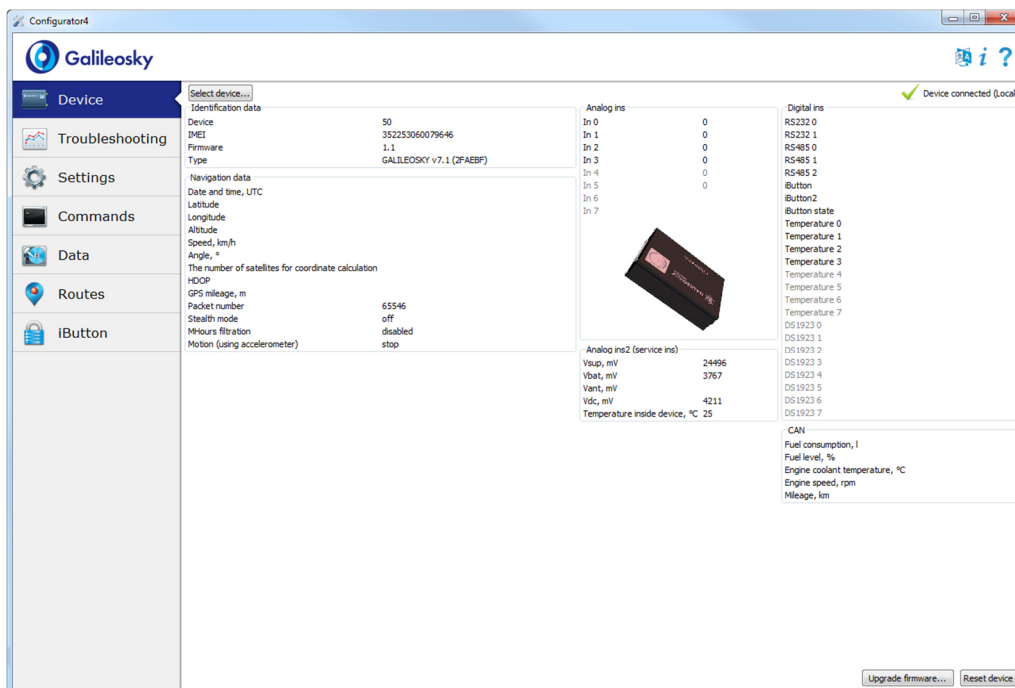

If there is a PIN code in the Terminal, the program will request it to access the settings. By wrong code entering the Terminal will disconnect from the computer, reset, connect to the Configurator again and wait for the right code enter.

For remote configuration and troubleshooting of the Terminal, click Select device... button. In the window appeared, enter your login and password to get the access to the remote configuration server. You can get the login and the password in RSA "Galileosky", LLC. department of technical support or by clicking the Register new user button.

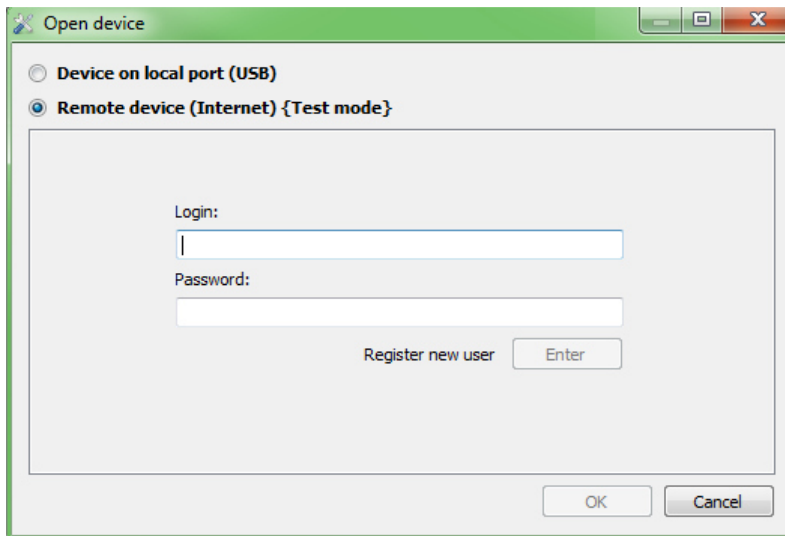

After successful authorization on the server, the form of terminals list management will become available. When connecting for the first time, the list of the controlled terminals will be empty. To add a Terminal to the list, click Register device button. During registration the Configurator will request a password for a particular Terminal, a factory password corresponds to IMEI of the Terminal; this can be later changed in the Configurator by the user. Terminals may be grouped.

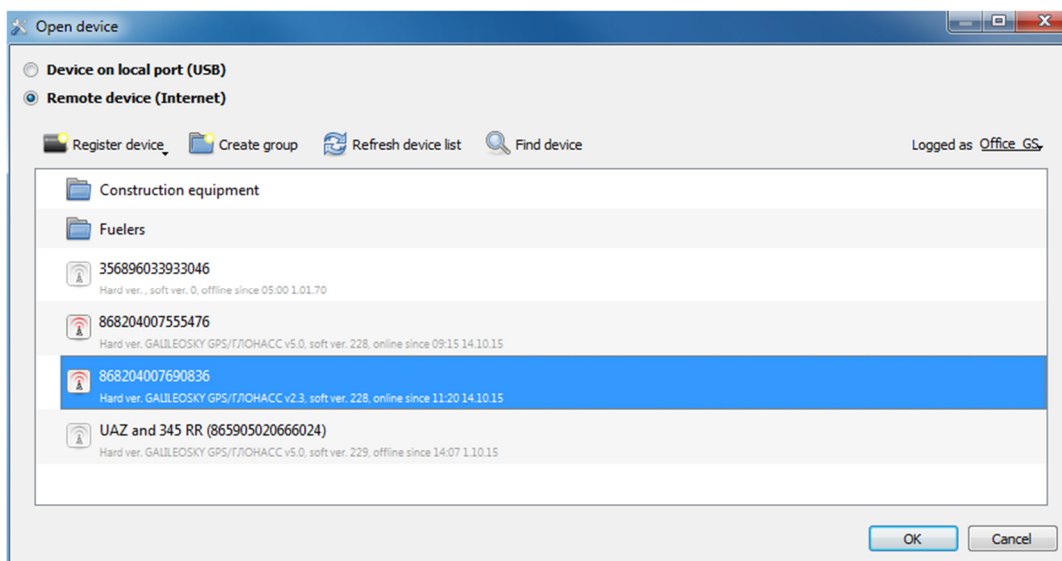

After selecting a particular Terminal, it can be controlled via the Configurator, the same way as it occurs with the USB-connection.

Troubleshooting tab

This tab allows us to see the current Terminal state through the troubleshooting reports.

The troubleshooting mode has the following buttons:

1) **Start /Stop**

The time scale displays the information about the server connection, packet recording, updating coordinates etc. and with a 10 sec interval.

2) **Clear troubleshooting window**

3) **Save** the Terminal`s troubleshooting results as a log-file which can be opened by any text editor.

4) **Search** in the troubleshooting history file.

GSM/3G-unit debug info

ATTENTION!

If the service has already been registered by the Terminal, another GPRS connection is only possible through switching off the GSM/3G-modem. It means that no money will be lost due to the minimum chargeable session.

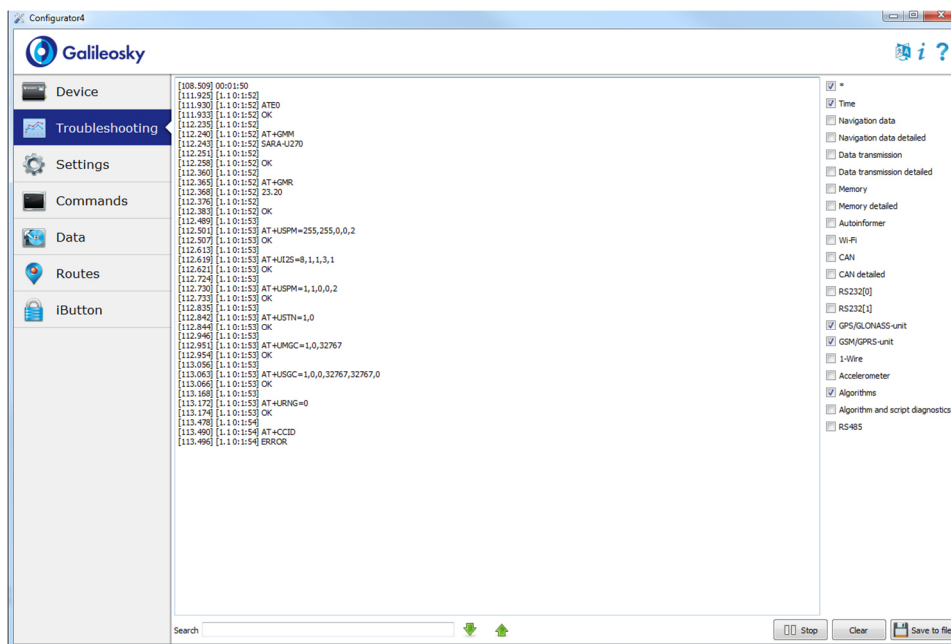

Troubleshooting messages	Description	Possible causes
GSM. Success turn on.	GSM unit is powered. Turning on is successful.	
GSM. Not success turn on!	GSM unit is powered. Turning on is denied by the unit.	

Troubleshooting messages	Description	Possible causes
GSM. Success init.	GSM unit initialization is successfully performed.	
GSM. Not success init!	GSM module initialization failed.	
GPRS. Activated.	GPRS initialization is successfully performed.	
GPRS. Not activate.	GPRS initialization failed.	GPRS is not activated on this SIM card. Not enough money on the account. GSM network is overloaded.
GPRS. Success connect to server.	Device server connection is successful	
GPRS. Not success connect to server.	Device server connection failed	The Server access is denied or wrong server settings for the device.
GPRS. Reconnect Number=N°	Number of server reconnections. N° - reconnection number.	
GPRS. Firstpack OK.	First packet has been sent to the server.	
GPRS. Firstpack False.[0]	The device has sent the first packet, but there is no confirmation at TCP/IP level.	GSM network is overloaded. The packet has been blocked by device brandmauer or FireWall.
GPRS. Firstpack False.[1]	The device has sent the first packet, but there is no confirmation at the application level.	GSM network is overloaded. The server is not handling the first packet.

SMS debug info

Troubleshooting message	Description
SMS. RX SMS.	A new SMS message is received
SMS. +79112299922	TelNum: received from a given phone number
Command: ID	ID command is received
SMS. TX OK.	Message is successfully sent
SMS delfromslot 1	handled SMS deleting (from the first SIM-card slot)

Troubleshooting message	Description
Not reply SIM. Slot 1	no SIM-card reply (from the first SIM-card slot)
GSM. No SIM-card	no SIM-card reply (the card is probably not inserted)

Internal Flash-memory (tracks memory) debug info

Troubleshooting message	Description
MEM. Inp-s	Point record reason is the change of inputs state;
MEM. Turn,dist	Point record reason is the change of distance between previous and new place or angle of driving direction;
MEM. Time	Record reason is time;
MEM. Write point - 200	Point with sequence number 200 is recorded.

GPS-unit debug info

Troubleshooting information	Description	Possible causes
SAT. Coord refresh.	Coordinates for current record have been updated by GPS unit. The vehicle is considered to be moving, packet has not been filtered off.	
SAT. Coord not refresh.	Coordinates for current record have not been updated. Filtering at stops is activated.	
SAT. Temper is low than -40	Device temperature is lower than -40°C. Operation at lower temperatures is impossible.	
SAT. Temper is high than 65	Device temperature is higher than +65°C. Operation at higher temperatures is impossible.	
SAT. Time out. Restart MCU.	No GPS data for 60 seconds. Device reset.	GPS unit is out of order. GPS unit failure.
GLONASS. Message received. Len = 401	Terminal received information from GLONASS unit. 401 byte is received.	
GPS. Message received. Len = 172	Terminal received information from GPS unit. 172 byte is received.	
GPS. Change baud rate = 1	Attempt to set GPS unit rate. Attempt № 1.	
SAT. Fix = 1	Current position is fixed (0 – not fixed);	
SAT. SatInUse = 7	7 satellites are used for navigation;	
SAT. Valid = 1	Coordinates are right (they can be used for location determination). This <i>Valid</i> 's not related to <i>valid</i> in packet and status.	

Troubleshooting information	Description	Possible causes
Galileo uses GLONASS	Terminal uses GLONASS system.	
Galileo uses GPS	Terminal uses GPS system.	
SAT. Incorrect data from GLNS/GPS module	Wrong data are received from the used unit (probably because of processor overload)	
SAT. Time out. Restart MCU	Terminal gets no data from receivers (GLNS/GPS)	
SAT. High Speed = 200	Navigation speed data filter turned on (this data will be skipped by the unit).	
SAT. HDOP is high = 6	Navigation HDOP data filter turned on (this data will be skipped by the unit).	
SAT. Jump = 5000	Navigation coordinate data filter turned on (leap to large distance occurred).	
SAT. First start OK. Sat count >= MIN	By the Terminal turning on the unit must get more MIN satellites (only in this case, the data are reliable).	

Other troubleshooting messages are not described, but they have intuitive names. If there are any questions, you will find the answer at our forum.

Command mode tab

This tab is intended to message a single command or a set of commands to the Terminal.

The command mode has the following buttons:

- 1) Run commands;
- 2) Run single command;
- 3) Open from file;
- 4) Save to file.

The commands will be identified whether you use capital or lower-case letters or both in turn.

ATTENTION!

There are no spaces in command name!

Spaces between parameters are not allowed!

Commands and parameters are separated by space.

Commands are separated by Enter.

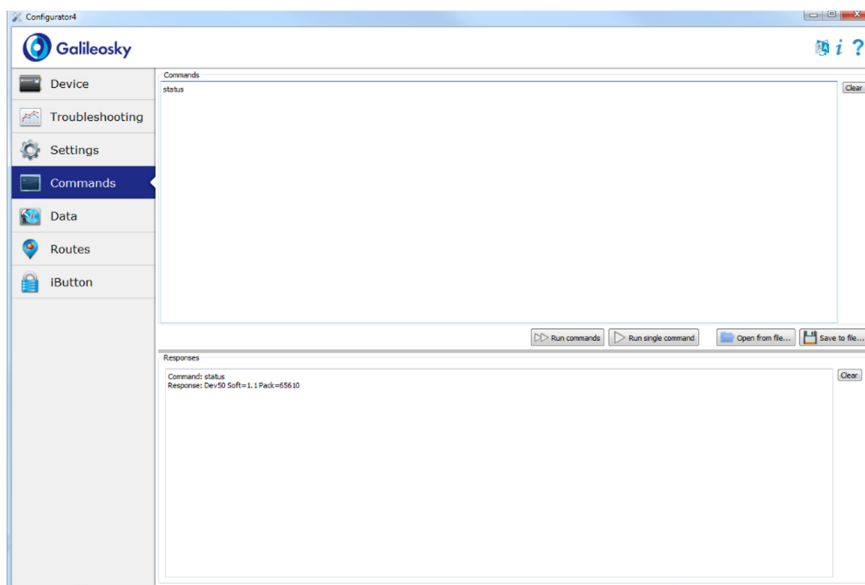

Single command example

An example of a command with a parameter:

Enter APN internet.beeline.ru,beeline,beeline as shown in the figure above and press **Run single command** button. The command and a response will be displayed in the Responses window.

Command: APN internet.beeline.ru,beeline,beeline

Response: GPRS: APN=INTERNET.BEELINE.RU, user=BEELINE, pass=BEELINE

To run only one command it is necessary to go to it in Commands window and press **Run single command** button.

Graphic interface settings

All main settings of the Terminal are placed on tabs in the program upper part.

Security

This tab allows setting SIM-cards PIN code, phone authorization password, list of authorized phone numbers and encryption key for data transfer to the server.

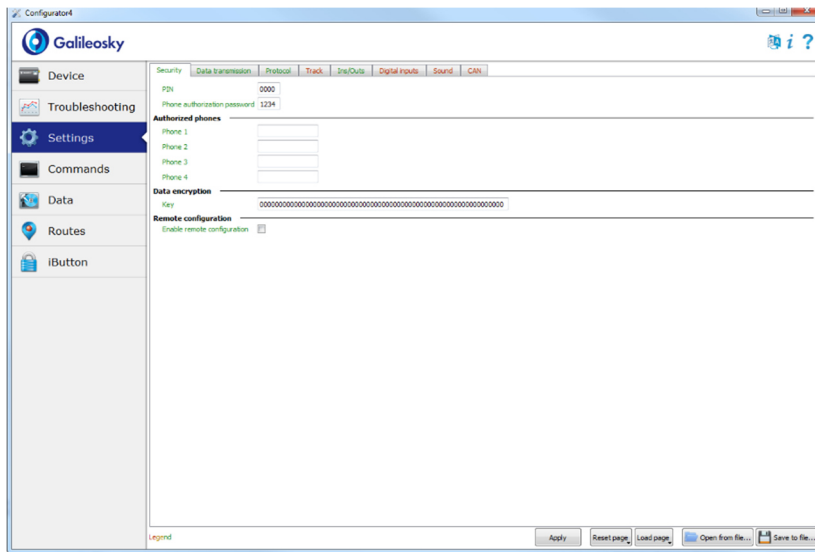

Data transmission

This tab allows setting SIM-card PIN code, APN for the Internet access, monitoring data processing servers, packet data transmission and international roaming.

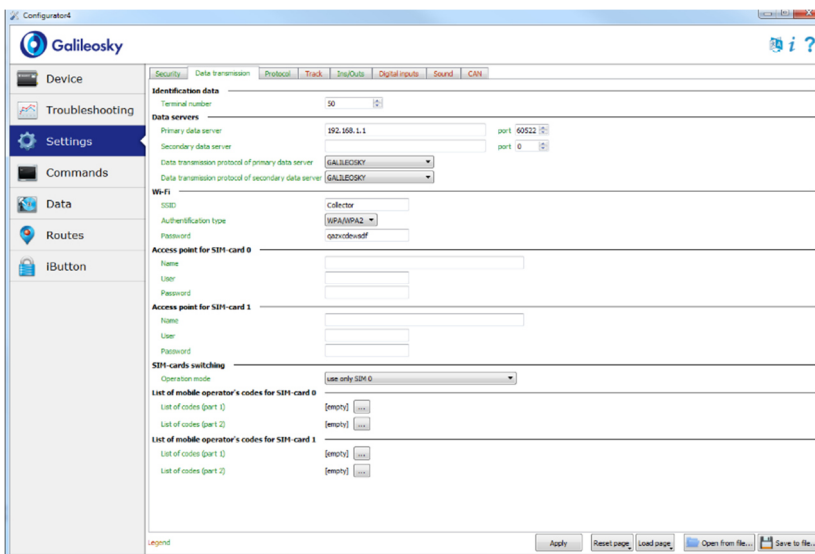

Protocol

The Terminal has its own data transmission protocol developed by Galileosky Ltd.

During device operating and data sending to the server, the following stages are possible:

- 1) Initialization of TCP/IP connection (does not need any additional settings);
- 2) Sending of initialization data described in the Head packet column (the data to be sent to the server are ticked in the first column);
- 3) If the Terminal has passed the first two stages, it starts sending accumulated packets according to the format described in the Main packet column.

To send the data the modem establishes a server connection and keeps it active even after sending the packet. It is done to save server connection traffic used to establish the connection to the server.

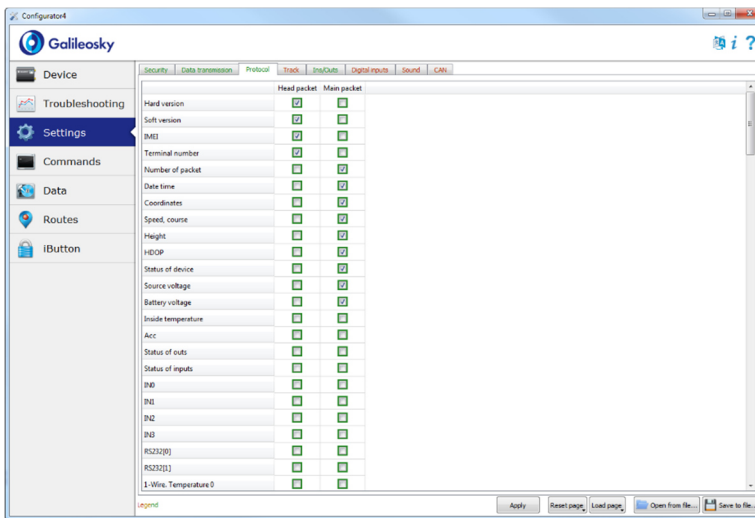

Power saving

This tab allows setting shutdown options of the Terminal units at stop, to reduce power consumption.

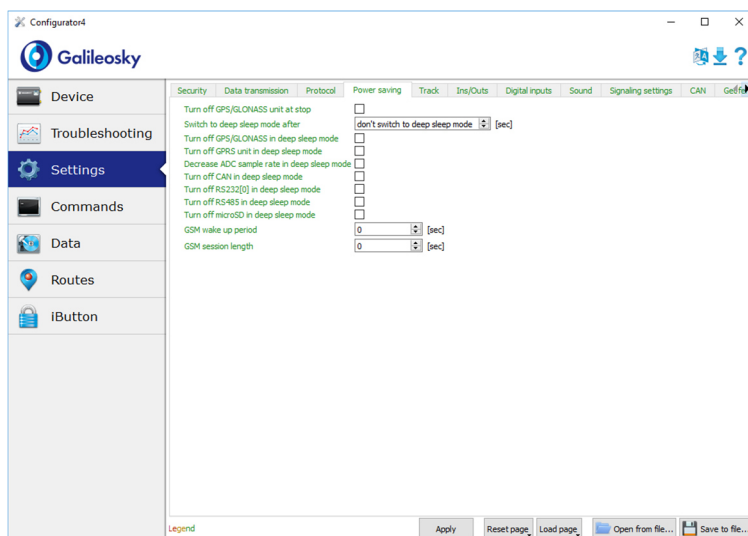

Track

This tab allows setting archive storage place and recording periods of coordinates at stops and in motion, details of track and false coordinates filtering.

The device filters coordinates by speed, acceleration, travelled distance, horizontal accuracy, number of satellites.

In addition, the Terminal allows filtering of coordinates crowding during stops by supply voltage at vehicles battery (Mhours command).

Parameters:

- supply voltage at stopped engine;
- supply voltage at started engine;

The first parameter is selected in the following way:

- 1) stop the engine for 5 minutes;
- 2) save the Vpit voltage parameter from Device tab.

The second parameter is selected in the following way:

- 1) start the engine;
- 2) save the Vpit parameter;
- 3) parameters of the mhours command are filled in and sent to the Terminal.

When the engine is started, the 9th bit will be set in the device status.

Each Terminal is equipped with an accelerometer which allows filtering coordinates crowding during stops. It is based on vehicles vibration.

Parameters:

- Sensitivity – a standard unit, where the sensitivity of the 600 units corresponds to the acceleration of 1g (gravitational acceleration)
- Time parameter. The Terminal switches on this filter when there is no vibration within a certain time period. The filter operates until the necessary amplitude acceleration is reached.

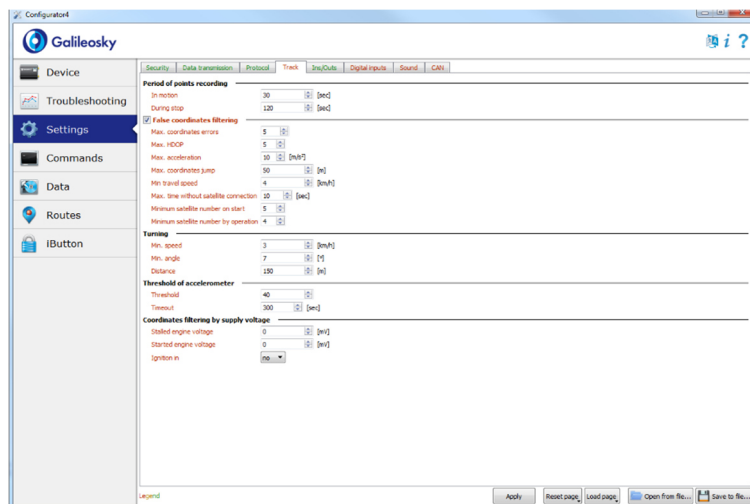

Inputs/Outputs

For inputs operating principles see section [Discrete-analog inputs \(DAI\)](#).

For discrete outputs description see section [Transistor outputs \(O/1\)](#).



Digital inputs

This option allows choosing the type of peripheral connected to RS232 inputs, setting iButton keys, setting up periodical camera shooting.

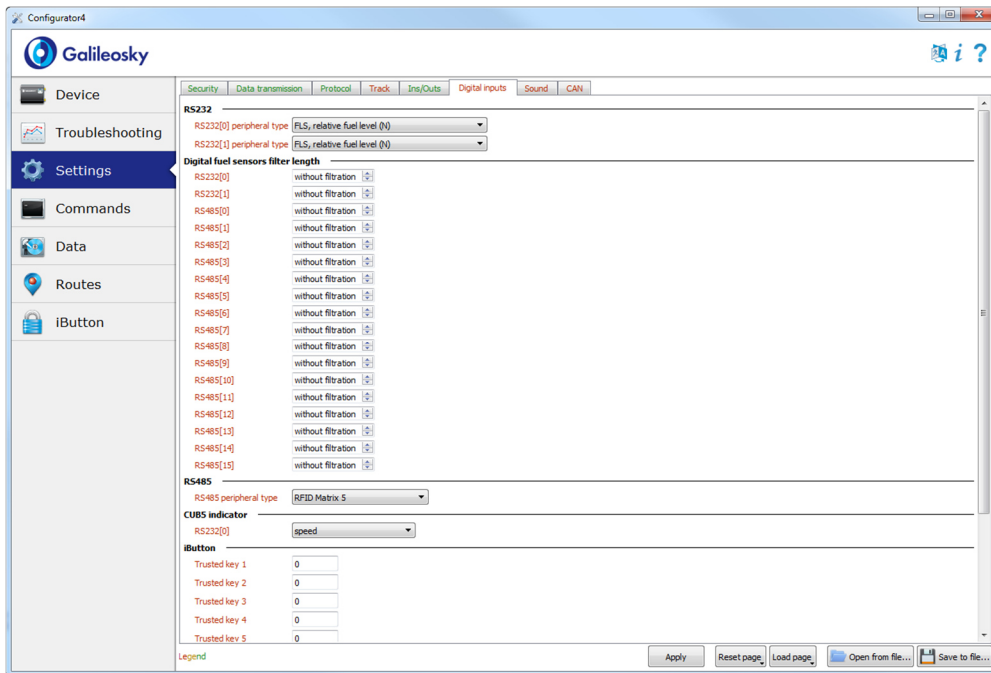

Sound

This option allows setting a microphone and sound gain via a GSM channel, the number of calls before autoanswer, as well as parameters of the Autoinformer.

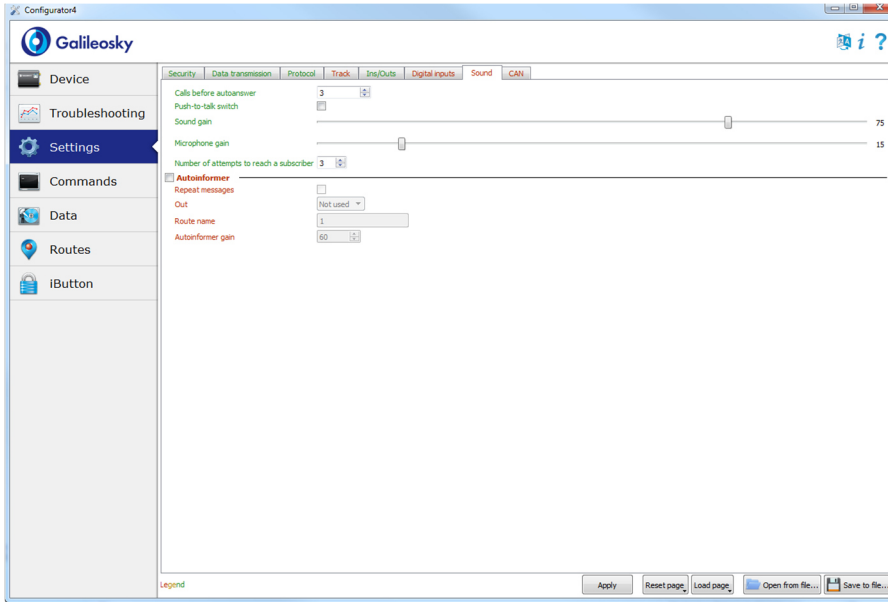

Signaling

This option allows setting the response of the Terminal to inputs state change, speed and coordinate change. You can set telephone numbers for SMS or call in case of signaling activation. Strike and incline determination may also be set here.

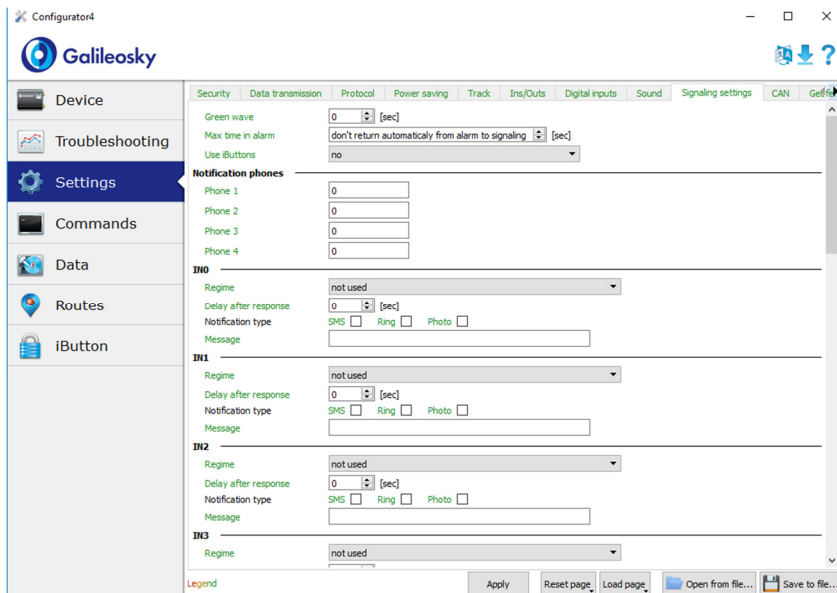

CAN

This option allows setting a CAN-filter and scanning the CAN-bus for message identifiers being used.

After clicking Listen CAN the CAN-scanner will be activated and received messages will be displayed in the right-hand panel. When scanning is completed, it is possible to set tags in the protocol, in which the bus data will be sent. To do this: choose CAN-identifier and tag and point transmitted part of the message with a mouse. To delete the filter the corresponding message identifier should be selected and deleted.

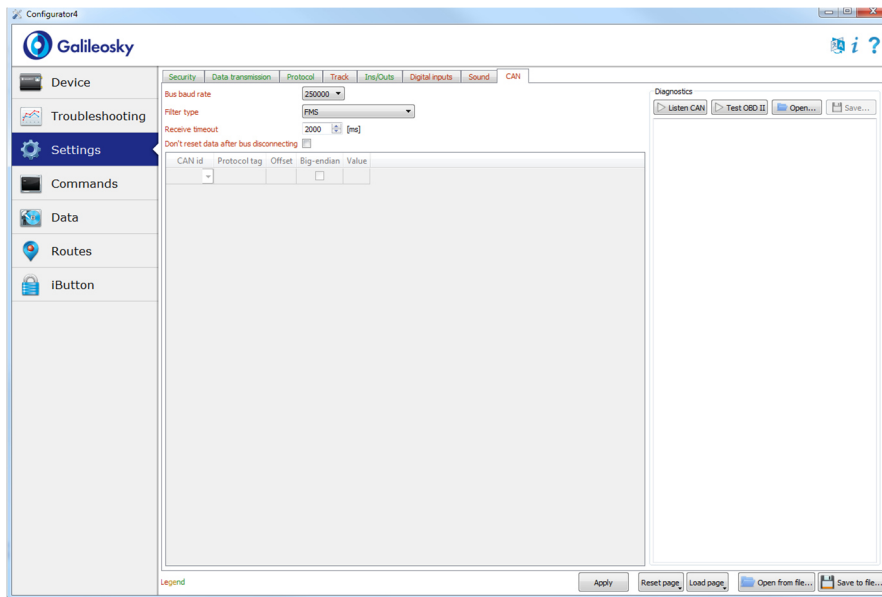

Geofences

On this tab it is possible to set the list of Geofences and behavior of the Terminal inside and outside them.

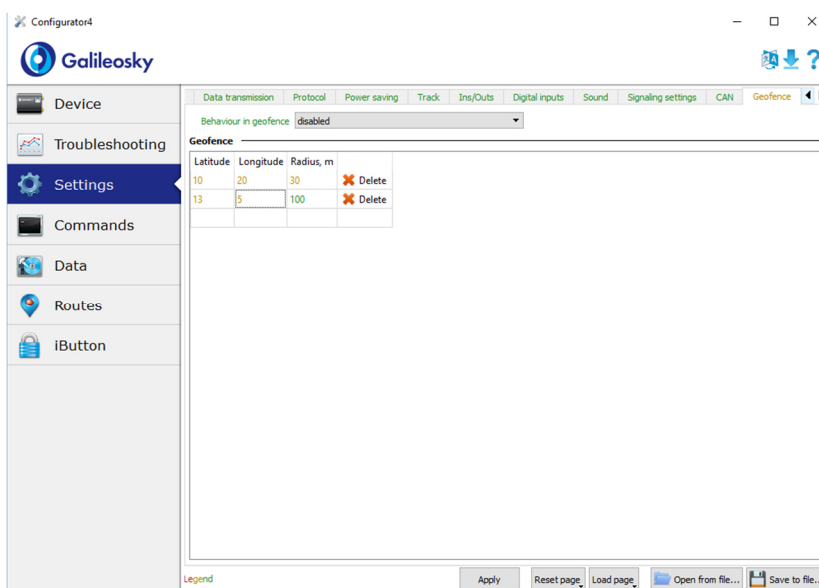

Data loading and sending to server

Data loading from the Terminal to file

This option allows transferring the data from the internal memory or an SD-card to computer files via a USB cable. By data loading from the internal memory one InternalFlash.csv file will be created, in the latter case there will be several files created sorted by the dates in the same way as they are stored on the card.

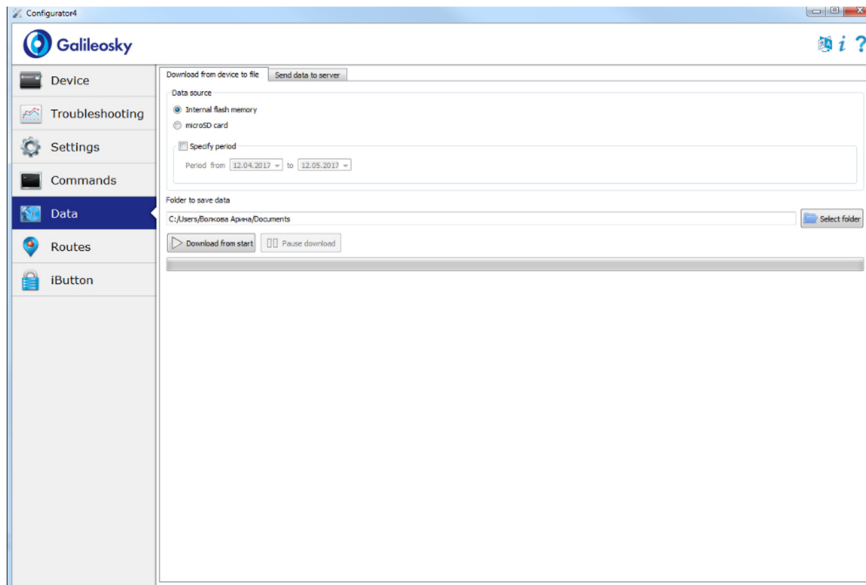

The Data transfer from the internal memory can be stopped and resumed; the data transfer from the SD-card can be stopped only if you disconnect the USB cable.

Sending data to server

This option allows sending the data previously transferred from the Terminal to any server emulating the Galileosky protocol. To send it you should specify the IP-address and the server port and choose a file or a catalogue to be sent. If a catalogue is chosen, the program will send all its data files. The process can be stopped and resumed.

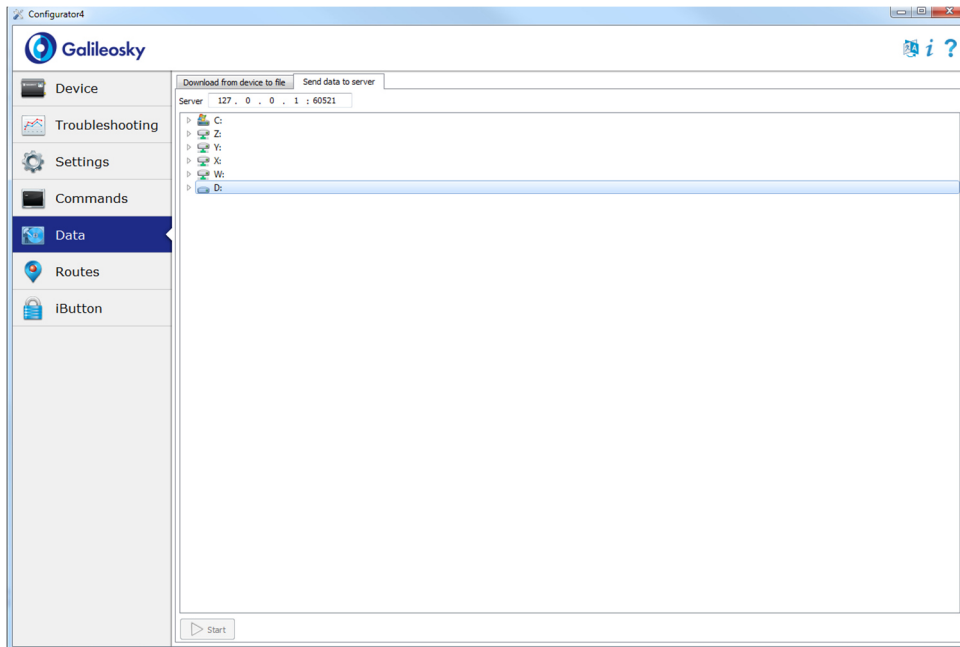

Routes for Autoinformers

This tab contains a graphical Autoinformers zones editor (section [Autoinformers function](#)).

The Internet access is required to display the map.

To edit the zones:

- 1) Insert a micro-SD card into the computer, choose the disk in the drop-down list. The route list and the track list will be loaded automatically.
- 2) Choose an edited route in the drop-down list or create a new one by clicking "+" on the right side of the route list. All stops will be loaded automatically, the map will move to the first stop.
- 3) Edit parameters of the zones. It can be done on the right panel as well as visually by moving red points with a mouse.
- 4) Create new zones. Click "+" on the right side of the stops list. A new zone will appear in the middle of the map, and then it can be edited.
- 5) Choose an audio file for the zone. It can be done in the Audio file drop-down list or you can load a new file by clicking "+" on the right side of the stops list. The following formats are supported: wav, mp3, flac, ogg, raw, gsm. The Configurator will automatically convert the file in appropriate format for the Terminal and copy it to the micro-SD card.
- 6) Press Save route to save changes to the micro-SD card.

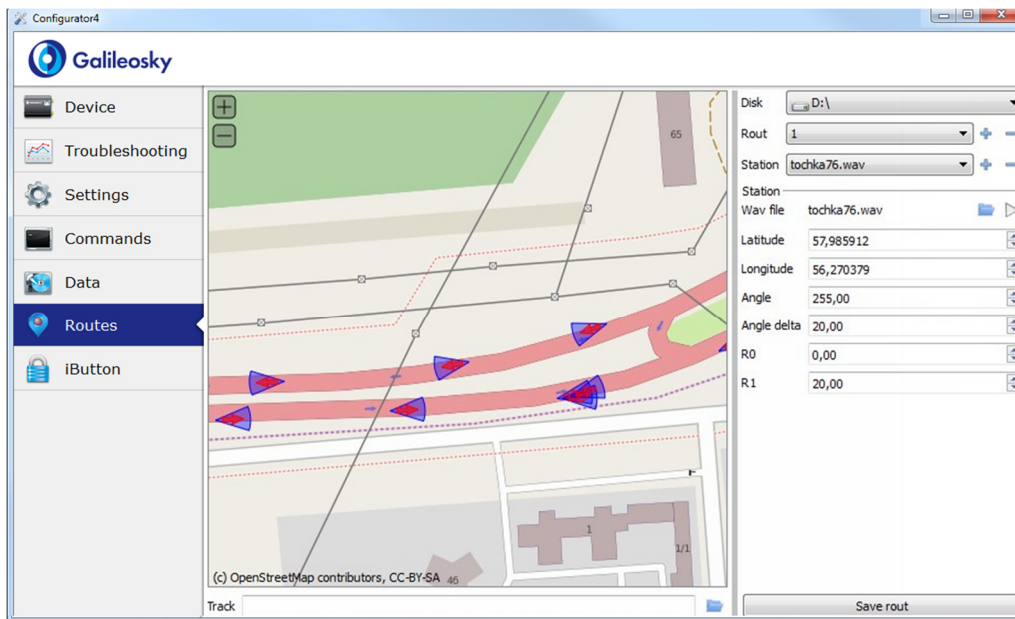

To make sure all zones are correct, download the track developed after a trip. The Configurator supports the tracks uploaded from the internal memory of the Terminal or stored on the micro-SD card in the csv format.

Trusted iButton keys

This tab contains the editor of a trusted iButton keys list.

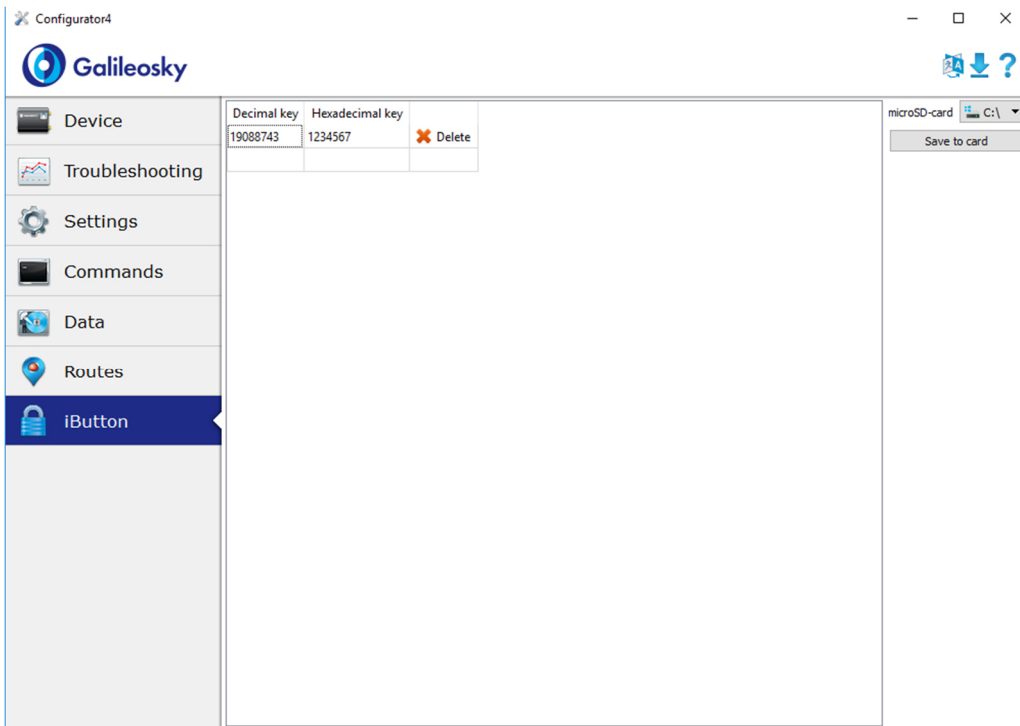

The list is stored on a microSD-card; to edit the list, perform the following:

1. Eject the microSD-card from the Terminal.
2. Insert the microSD-card into the computer and choose the disk in the drop-down list; the list of trusted iButton keys will be loaded automatically.
3. Keys may be entered either in decimal or in hexadecimal form; the corresponding value in another column will be converted automatically.
4. Click Save to disk button to save the changes to the microSD-card.

The list of keys is stored in the keys.bin file; it can be copied and used in microSD-cards of other Terminals.

Commands List

To request current settings you need to issue a command without any parameters.

Settings for SMS control

Command format

AddPhone xxxx[,n]

Parameters

xxxx - is a four-digit password, 1234 by default
n – slot number (0-3) where a telephone number will be saved.

Explanation

When you configure the Terminal from a cell phone, you should first authorize it by using the command. Up to 4 telephone numbers can be authorized.

Example

Request: AddPhone 1234
Reply: Phones (0) = 890101243456 (1) = (2) = (3) =

Command format

ChangePass aaaa

Parameters

aaaa - is a numeric four-digit password;

Explanation

Changing and viewing the current password.

Example

Request: ChangePass 5678
Reply: Password changed to '5678'

Command format

Phones P1,P2,P3,P4

Parameters

P1,P2,P3,P4 – authorized phone numbers in international format.

Explanation

Getting and setting the list of authorized phones

Example

Request: Phones +7901012345,,,
Reply: Phones (0)=+790101243456 (1)= (2)= (3)=

Data transmission settings

Command format

APN **a,u,p**

Parameters

a – access point name

u – user

p – password

Explanation

Access point settings for a SIM-card (SIM0)

Example

Request: APN internet.beeline.ru,beeline,beeline

Reply: GPRS:APN=internet.beeline.ru, user=beeline, pass=beeline

Command format

APN2 **a,u,p**

Parameters

a – access point name

u – user

p – password

Explanation

Access point settings for a SIM-card (SIM1) or a SIM-microchip

Example

Request: APN2 internet.beeline.ru,beeline,beeline

Reply: GPRS2:APN=internet.beeline.ru, user=beeline, pass=beeline

Command format

OPS0 **n1,n2,n3,n4,n5,n6,n7,n8,n9,n10,n11,n12,n13,n14,n15**

Parameters

n1-n15 – preferred GSM-networks

Explanation

A list of preferred GSM- networks for a SIM-card (SIM0). The network is defined by a mobile country code and a mobile operator code (the list of codes is given in http://www.itu.int/dms_pub/itu-t/opb/sp/T-SP-E.212A-2010-PDF-E.pdf), for example, the Russian Federation code is 250.

Example

Request: OPS0 25001,25099

Reply: OPS0:25001,25099,,,,,,,,,,,,;

Command format

OPS02 n16,n17,n18,n19,n20,n21,n22,n23,n24,n25,n26,n27,n28,n29,n30

Parameters

n16-n30 -- preferred GSM-networks

Explanation

Additional list of preferred GSM-networks for a SIM-card (SIM0).

Example

Request: OPS02 25001,25099

Reply: OPS02:25001,25099,,,,,,,,,,,,;

Command format

OPS1 n1,n2,n3,n4,n5,n6,n7,n8,n9,n10,n11,n12,n13,n14,n15

Parameters

n1-n15 – preferred GSM-networks

Explanation

A list of preferred GSM-networks for a SIM-card (SIM1) or a SIM-microchip.

Example

Request: OPS1 25001,25099

Reply: OPS1:25001,25099,,,,,,,,,,,,;

Command format

OPS12 n16,n17,n18,n19,n20,n21,n22,n23,n24,n25,n26,n27,n28,n29,n30

Parameters

n16-n30 – preferred GSM-networks

Explanation

Additional list of preferred GSM-networks for a SIM-card (SIM1) or a SIM-microchip.

Example

Request: OPS12 25001,25099

Reply: OPS12:25001,25099,,,,,,,,,,,,;

Command format

SIMSwitch mode

Parameters

mode – SIM-cards switching algorithm:

0 – only SIM0 is used

1 – cyclic switching between the SIM-cards, if you cannot send the data for 9 minutes

2 – switching according to the preferred GSM-networks list.

3 – only SIM1 or SIM-microchip is used;

Explanation

Setting of an algorithm of switching between a SIM-card and a SIM-microchip.

Example

Request: SIMSwitch 1

Reply: SIMSwitch: 1;

Command format

Serverip host,port

Parameters

host – domain name of a server or its IP-address;

port – server port.

Explanation

Main server parameters where the monitoring data will be transmitted to.

Example

Request: Serverip m.7gis.ru,60521

Reply: SERVERIP=m.7gis.ru:60521

Request: Serverip 46.146.233.216,60521

Reply: SERVERIP=46.146.233.216:60521

Command format

Serverip2 ip1,ip2,ip3,ip4,port

Parameters

host – domain name of a server or its IP-address;

port – server port.

Explanation

Additional server parameters.

Command format

ServersCfg t

Parameters

t – Time of connection with one server, [sec]. When the value is equal to 0, the data will be transmitted only to the main server.

Explanation

Sets the time of server connection session.

Example

Request: ServerCfg 120

Reply: SERVERCFG:SeansTime=120;

Command format

ID n

Parameters

n - terminal number.

Explanation

Changes terminal number. The same number is used as the device identifier in the EGTS protocol.

Example

Request: ID 123

Reply: ID=123

Command format

Roaming MCC_MNC,Size,Interval

Parameters

MCC_MNC – a mobile code of the country where the data can be transmitted without any limitations (the list of codes is given in http://www.itu.int/dms_pub/itu-t/opb/sp/T-SP-E.212A-2010-PDF-E.pdf), for example, the Russian Federation code is 250 or it may be a combination of mobile country and mobile operator codes. Zero means that there are no special roaming settings;

Size – maximum number of bytes which can be transmitted during one connection session in roaming. When the value is equal to 0, only the first packet is transmitted;

Interval – connections interval in hours.

Explanation

Settings of data transmission in roaming.

Example

Request: Roaming 25099,10000,24

Reply: ROAMING:Home=25099,MaxBytes=10000,Interval=24;

Command format

Protocol n

Parameters

n – version of data transmission protocol:

- 0 – Galileosky protocol;
- 3 – EGTS;
- 4 – Galileosky protocol with compression

Explanation

Choice of monitoring data transmission to the server.

Example

Request: Protocol 0

Reply: PROTOCOL:0;

Command format

Car VIN,N

Parameters

VIN – VIN of the vehicle, is transmitted in EGTS protocol.

N – vehicle`s number plate, is transmitted in EGTS protocol.

Explanation

Settings of the vehicle description.

Example

Request: car 123456789,A000AA00

Reply: CAR:123456789,A000AA00;

User Manual Galileosky 5.1

Command format

MainPack2 bbbbbbbbbbbbbbb

Parameters

bbbbbbbbbbbbbb – tag set from 129 to 256.

If b is replaced by 1, the tag is on.

If b is replaced by 0 the tag is off.

Tag numeration order is given in section [Galileosky protocol data](#).

Explanation

Main packet configuring.

Example

Request: MainPack2 1 10000

Reply: MainPack2=1 10000b

This means that tags 129, 130, 131, 132 are off and tags 133 and 134 are on. All the following tags are off.

Command format

MainPackBit index,value

Parameters

index –tag number, which is on or off for transmission to the server

value – 1 if this tag should be transmitted to the server

0 if this tag should not be transmitted to the server

Tag numeration order is given in section [Galileosky protocol data](#).

Explanation

Main packet configuring.

Example

Initially the second tag is off:

HeadPack=1 100b

Switch on this tag.

Request: HeadPackBit 2,1

Reply: HeadPack=1 100b

Command format

DataKey key

Parameters

Key – data encryption key in hexadecimal form, if it is equal to 0, data are not encoded.

Explanation

Specifies the key that encrypts the transmitted data.

Track parameters setting

Command format

Turning V,A,D,S,dS

Parameters

V – minimum speed that enables drawing of the track at turnings, [km/h];

A – minimum turn angle for the Terminal to record a track point, [°];

D – the distance above which the next packet will be saved to the terminal memory, [m];

S – the speed above which for dS-multiple value track point will be recorded, [km/h];

dS – speeding interval, [km/h].

Explanation

Configures track detail representation.

Example

Request: Turning 3,10,300,60,20

Reply: TURNING:Speed=3,Angle=10,Distance=300,SpeedEx=60,SpeedDelta=20

Command format

WrPeriod x,y

Parameters

x – Period of packet recording in memory in motion, [sec.];

y – Period of packet recording in memory when the vehicle stops, [sec.].

Explanation

Period of packets recording when the vehicle is moving or when it stops.

Example

Request: WrPeriod 60,180

Reply: WRPERIOD move=60 parking=180

Command format

GPS.Correct OnOff,MaxWrong,HDOP,Spd,Acc,Jump,TravelSpeed

Parameters

OnOff –coordinates filtering is on(1) or off(0);

MaxWrong – the number of wrong coordinates to be filtered (the recommended number is 5). This parameter accounts errors of acceleration exceed and jump, for other parameters the coordinates are always filtered;

HDOP – Maximum HDOP above which the coordinates are not updated;

Spd – Maximum speed. When it is exceeded, coordinates are considered false and are not updated, [km/h];

Acc –GPS or GLONASS data based acceleration [m/s²];

Jump – Maximum coordinate jump in the nearest 2 seconds, [m];

TravelSpeed – Minimum speed for coordinates to be updated, [km/h]. This function is not suitable for low speed vehicles (tractors, asphalt placing machines)

Explanation

Allows filtering false coordinates: jumps when the vehicle stops, in or out of tunnels, near high-rise buildings

Example

Request: GPS.CORRECT 1,5,2,150,3,50,3

Reply: GPS.correct: OnOff=1, MaxWrong=5, MaxHDOP=2, MaxSpd=150, MaxAcc=3, MaxJump=50, MaxTravelSpeed=3;

Command format

GPS.Correct2 MaxNoSatTime,MinSatStart,MinSatWork

Parameters

MaxNoSatTime – maximum time without satellite connection when no disconnection is registered, [sec.];

MinSatStart – minimum number of satellites to be connected to when the Terminal is on;

MinSatWork– minimum number of satellites during operation of the Terminal. If the number is smaller, a disconnection will be registered

Explanation

These settings affect coordinates updating, if filtering is on by **GPS.Correct** command.

Example

Request: GPS.CORRECT2 10,5,4

Reply: GPS.correct2:MaxNoSatTime=10,MinSatStart=4,MinSatWork=3;

Command format

AccSens Sens,TO

Parameters

Sens – accelerometer sensitivity.

TO – the time after the vehicle stops, during which coordinates are updated, [sec].

Explanation

This function allows avoiding unnecessary outliers after the vehicle stops.

Default value is 40,300.

Sens value equal to 600 is 1g (g –gravitational acceleration)

Example

Request: AccSens 40,300

Reply: Accelerometer sensitive: sens = 40, time out=300

Command format

Ignition N

Parameters

N – an input used as an ignition sensor:

0 – ignition sensor is not used;

1 – input 0 is used as ignition sensor;

2 – input 1 is used as ignition sensor;

3 – input 2 is used as ignition sensor;

4 – input 3 is used as ignition sensor;

Explanation

If there is no response for a given input, vehicle is considered to be not started, and coordinates are not updated. It allows avoiding outliers after the vehicle stops. Triggering on input is determined by the limits set by InCfg command (section Analog- discrete inputs settings).

Example

Request: Ignition 1

Reply: IGNITION:1;

Command format

Shock Mode,Angle,Timeout,ShockSens

Parameters

Mode – strike determination mode:

0 – strike determination is switched off;

1 – strike determination is switched on, X axis is in vertical position;

2 – strike determination is switched on, Y axis is in vertical position;

3 – strike determination is switched on, Z axis is in vertical position;

Angle – maximum incline angle [0°-180°], value equal to 180 switches off incline determination;

Timeout – maximum allowable time when incline angle is exceeded, [sec.].

ShockSens – maximum acceleration by exceed of which a strike is detected. 600 points – gravitational acceleration.

Explanation

Switching on strike and incline determination mode.

Example

Request: Shock 3,30,5

Reply: Shock: Mode=3,MaxAngle=30,RT=5;

Command format

Mhours LoLevel,HiLevel

Parameters

LoLevel – input voltage + supply voltage by stopped engine, [mV];

HiLevel – input voltage +supply voltage by started engine, [mV];

Explanation

Allows filtering false coordinates after the vehicle stops

Example

Request: mHours 12000,14500

Reply: Mclock: lolevel=12000,hilevel=14500;

Geofences settings

Command format

Dzone Mode

Parameters

Mode – operation mode inside a geofence:

0 – geofence processing is switched off;

1 – coordinates updating prohibition inside a geofence;

2 – GSM/3G-unit switching off inside a geofence, 3 – updating prohibition and GSM/3G-unit switching off at the same time.

Explanation

Allows setting of terminal behavior inside a geofence.

Example

Request: Dzone 3

Reply: Dzone:3;

Command format

DzoneAdd Lat,Lon,R

Parameters

Lat – geofence centre latitude;

Lon – geofence centre longitude;

R – geofence radius in meters.

Explanation

Allows adding a geofence. Each geofence is a circle with the determined center and radius.

Example

Request: DzoneAdd 55.9999,66.123456,100

Reply: DzoneAdd:lat=55.9999,lon=66.123456,rad=100;

Command format

DzoneDel Lat,Lon

Parameters

Lat – geofence center latitude;

Lon – geofence center longitude.

Explanation

Allows deleting the geofence, set by its center coordinates.

Example

Request: DzoneDel55.9999,66.123456

Reply: DzoneDel:lat=55.9999,lon=66.123456;

Command format

DzoneClear

Explanation

This parameter deletes all geofences.

Example

Request: DzoneClear

Reply: Dead zones are cleared

Command format

DzoneCount

Explanation

This parameter allows getting the number of all geofences set in the Terminal.

Example

Request: DzoneCount

Reply: DZONECOUNT:2;

Command format

DzoneInfo N

Parameters

N – Ordinal number of geofence beginning with 0.

Explanation

This parameter gives an access to the geofence's data.

Example

Request: DzoneInfo 0

Reply: DZONEINFO:Lat=10.000000, Lon=20.000000, Rad=30;

Information commands

Command format

Status

Explanation

Allows receiving device status at the moment of sending a command.

Dev – this device number;

Soft – current firmware version;

Pack – last recorded packet serial number;

TmDt – Current time and date;

Per – Current packet saving period (different when the vehicle is moving and stops);

Nav – Coordinates determination accuracy. 0 – coordinates are found.

Lat – Latitude;

Lon – Longitude;

Speed – Linear speed (vehicle speed);

HDOP – Horizontal accuracy (The closer to 1, the better);

SatCnt – Number of available satellites;

A – movement directional angle

Example

Request: Status

Reply: Dev50 Soft=91 Pack=17230 TmDt=10:58:6 20.6.9 Per=60 Nav=0 Lat=60.4007

Lon=31.0070 Speed=0.0194 HDOP=0.88 SatCnt=10 A=27.55

Command format

imei

Explanation

Allows obtaining a unique GSM/3G-unit identifier, 15byte and CCID of SIM-microchip, if there is one.

Example

Request: IMEI

Reply: IMEI 123456789012345, 12345678901234567890

Command format

imsi

Explanation

Allows obtaining a unique IMSI identifier of a SIM-card

Example

Request: IMSI

Reply: IMSI: 123456789012345;

User Manual Galileosky 5.1

Command format

inall

Explanation

Allows analog input values in0..in3 as well as digital fuel level sensor values and temperature, and accelerometer values with respect to three axes (10 bit for each axis starting with the zero bit) being obtained.

Example

Request: inall

Reply: INALL:in0=0,in1=0,in2=0,in3=0, RS232=10,1,Acc=332943891;

Command format

Insys

Explanation

Allows obtaining external source voltage, internal battery voltage, GPS aerial voltage, the main power bus voltage of the Terminal and also the temperature inside the Terminal..

Example

Request: insys

Reply: INSYS: Pow=12438,Vbat=4196,Vant=2921,Vdc=4115,Temper=37

Command format

RS485

Explanation

Allows receiving a value of the digital fuel level sensor connected via the RS485 interface. For each sensor the command prints fuel level and temperature values

Example

Request: RS485

Reply:

RS485 100,0;100,1;100,2;100,3;100,4;100,5;100,6;100,7;100,8;100,9;100,10;
100,11;100,12;100,13;100,14;100,15;

Command format

Temex0

Explanation

Allows finding temperature from the first four external DS18S20 thermometers. Format: the lower byte is the thermometer identifier; the higher byte is the temperature itself. To calculate the temperature the obtained value must be divided by 256 and rounded off to the whole number, with the fractional part deleted.

Example

Request: temex0

Reply: TemEx0: DS0=0,DS1=0,DS2=0,DS3=0

Command format

Temex1

Explanation

Allows finding temperature of the second four external DS18S20 thermometers. Format: the lower byte is the thermometer identifier; the higher byte is the temperature itself. To calculate the temperature the obtained value must be divided by 256 and rounded off to the whole number, with the fractional part deleted.

Example

Request: temex1

Reply: TemEx1: DS4=0,DS5=0,DS6=0,DS7=0

Command format

Hum0

Explanation

Allows finding the temperature of the first four DS1923 humidity sensors.

ID – sensor identifier;

T – temperature in Celsius degrees

H – humidity in %.

Example

Request: Hum0

Reply:ID0=1,T0=20,H0=20.0,ID1=2,T1=30,H1=30.0,ID2=3,T2=25,H2=40.0,ID3=5,
T3=15,H3=50.0

Command format

Hum1

Explanation

Allows finding the temperature of the second four DS1923 humidity sensors.

ID – sensor identifier;

T – temperature in Celsius degrees

H – humidity in %.

Example

Request: Hum1

Reply: ID4=1, T4=20, H4=20.0, ID5=2, T5=30, H5=30.0, ID6=3, T6=25, H6=40.0, ID7=5, T7=15, H7=50.0

Command format

Canibut

Explanation

Allows obtaining current CAN-bus state and iButton decimal value

Example

Request: canib

Reply: CAN_Ib: CANA0=0, CANA1=0, CANB0=0, CANB1=0, iBut=0

Command format

statall

Explanation

Allows obtaining device, inputs, outputs decimal status and mileage according to GPS/GLONASS data.

Example

Request: statall

Reply: StatAll: Dev=1, Ins=2, Outs=7, Mileage=152;

Command format

AccType

Explanation

Allows obtaining accelerometer type. Returns "analog" for analog type and "digital" for digital type.

Example

Request: AccType

Reply: AccType: digital

Command format

LastCmd N

Parameters

N- number of recorded command, beginning from 0

Explanation

Allows overlooking the archive of the last executed commands. Returns the command source, time, date and text of the command.

Example

Request: lastcmd 2

Reply: USB 095659 20140305 ACTIVECAN 1

Service commands

Command format

PIN N

Parameters

N – four-digit PIN-code of SIM-cards.

Explanation

SIM-card PIN-code and password setting for settings access in the Configurator. The default PIN-code is 0. If you enter the wrong code, the Terminal will be blocked for 25 seconds, and then reset. PIN-code is identical for both SIM-cards.

Example

Request: PIN 1234

Reply: PIN:1234;

Command format

Archive type

Parameters

type – data source for sending to the server:

0 – archive from the internal flash-memory;

1 – archive from the microSD card.

Explanation

Selection of data source for sending to the server. After command execution it is necessary to reset the Terminal. Before you select a microSD card, delete the archive, created by earlier firmwares, (EraseTrackSD or delete files from Track catalogue through the Card-Reader).

Example

Request: ARCHIVE 0

Reply: ARCHIVE:0;

Command format

FlashArchive SendOrder

Parameters

SendOrder – order of data transmission from archive to server:

0 – the data are sent deep into the archives; the most current data are sent first, then the oldest ones.

1 – the data are sent in chronological order.

Explanation

Setting of the data transmission order to the server

Example

Request: FLASHARCHIVE 1

Ответ: FLASHARCHIVE: StraightSendOrder=1;

Command format

EraseCfg

Explanation

Setting default configuration.

Example

Request: EraseCfg

Reply: ERASECFG

Command format

EraseTrack

Explanation

Deleting all tracks from the memory.

Example

Request: EraseTrack

Reply: ERASETRACK

Command format

EraseTrackSD

Explanation

Deleting all tracks from the SD memory.

Example

Request: EraseTrackSD

Reply: ERASETRACKSD

Command format

ColdStart

Explanation

GLONASS unit cold start.

Example

Request: ColdStart

Reply: GLONASS cold start

Command format

Reset

Explanation

Allows resetting the device remotely.

Example

Request: Reset

Reply: Reset of device. Please wait 15 seconds...

Command format

Upgrade N

Parameters

Firmware upgrading up to the specified one. If 0 is specified, the Terminal will upgrade firmware up to the last stable one.

Explanation

Firmware upgrading up to the specified one.

Example

Request: Upgrade 47

Reply: UPGRADE SOFT= 47

Command format

SleepMode OffOnStop,DST,GNSS,GPRS,ADC,CAN,RS232,RS485,SD,WakeUp,ST

Parameters

OffOnStop – 0 – do not turn off GPS\GLONASS unit at a stop;

1 – turn off GPS\GLONASS unit at a stop.

DST – Time spent at a stop, after which the Terminal will switch to the deep sleep mode;

GNSS – turn off GPS\GLONASS unit in the deep sleep mode;

GPRS –turn off GSM/3G-unit in the deep sleep mode;

ADC – reduce ADC sampling rate in the deep sleep mode; the maximum frequency that can be measured at inputs is reduced by 2 and the minimum impulse period that can be registered increases twofold;

CAN – turn off the CAN in the deep sleep mode;

RS232 – turn off RS232 in the deep sleep mode;

RS485 – turn off RS485 in the deep sleep mode;

microSD – turn off the microSD card in the deep sleep mode, the reading of trusted iButton keys is supported;

WakeUp – a period in seconds between connections to a server in deep sleep mode;

ST – a length of connection to a server in deep sleep mode.

Explanation

Power saving mode control. In the deep sleep mode no 1Wire sensors sampling and no battery charging are performed.

Example

Request: SLEEPMODE 1,60,1,1,1,1,1,1,3600,600

Reply:SLEEPMODE:OffGNSSOnStop=1,DSTimeout=60,

GNSS=1,GPRS=1,ADC=1,CAN=1,RS232=1, RS485=1,SD=1, GSMWakeUp=3600,

SessionLen=60;

Command format

RemoteConfig OnOff

Parameters

OnOff – turning on the remote configuration function:

- 0 – remote configuration is off;
- 1 – remote configuration is on.

Explanation

Turns on and off the remote configuration (section [Remote configuration](#))..

Example

Request: RemoteConfig 1

Reply: REMOTECONFIG:1;

Voice communication settings

Command format

GSMVolume k,m

Parameters

k – GSM-channel sound gain [1÷100].

m – GSM-channel microphone gain [1÷15].

The greater the parameter, the greater the gain.

Explanation

Allows speakerphone sound gain parameters being customized.

Example

Request: GSMVolume 75,15

Reply: GSMVOLUME=75,15

Command format

AutoAnswer n

Parameters

n – the number of calls before autoanswer. [0÷10]

If the parameter is equal to 0, the function is off.

Explanation

Incoming call results in the terminal automatic answer.

Example

Request: AutoAnswer 1

Reply:: AUTOANSWER=1

User Manual Galileosky 5.1

Command format

Calls N

Parameters

N – the number of call attempts

Example

Request: Call 3

Reply: CALL:3;

Command format

RingTo N

Parameters

N –a telephone number.

Explanation

Making a call from the Terminal to the given telephone number.

Example

Request: RingTo 89119988899

Reply: RINGTO=89119988899

Command format

SendSMS Tel,Msg

Parameters

Tel – a telephone number to which SMS is sent

Msg – SMS template. It may contain parameters to insert current data:

%IMEI – terminal's IMEI, %LAT – latitude, %LON – longitude.

Explanation

Sending SMS to the given telephone number

Example

Request: SendSMS 89119988899, Test

Reply: SMS sheduled

Command format

Tangenta OnOff

Parameters

OnOff – use a push-to-talk;
0 – a speaker and a microphone are connected;
1 – a push-to-talk KMC-25 is connected.

Explanation

Voice communication setting

Example

Request: Tangenta 1
Reply: TANGENTA:1;

Analog-discrete inputs setting

Command format

InCfg_num_in ft,fl,up_low,up_hi,down_low,down_hi,imp_null

Parameters

num_in – an input number, beginning from 0;

ft – filter type

- 0 – mean value computation;
- 1 – pulse count;
- 2 – frequency count
- 4 – Wiegand26 Data0
- 5 – Wiegand26 Data1

fl – filter length. It is used for average and discrete signal function;

up_low – lower limit of a discrete signal triggering, [mV];

up_hi – upper limit of a discrete signal triggering, [mV];

down_low – lower limit of a discrete signal failure, [mV];

down_hi – upper limit of a discrete signal failure, [mV];

imp_null – pulses counter behavior: 1 – counter is set to zero, 0 – counter continues increasing.

Explanation

Allows one of 4 analog/discrete inputs being configured.

Example

Request: InCfg0 0,10,8000,15000,0,3000,0

Reply:

INCFG0:FiltType=0,FiltLen=10,UpLow=8000,UpHi=15000,DownLow=0,DownHi=3000,ImpNull=0;

Command format

PowInCfg fl,up_low,up_hi,down_low,down_hi

Parameters

fl – average length of the filter [1÷50];

up_low – lower limit of a discrete signal triggering, [mV];

up_hi – upper limit of a discrete signal triggering, [mV];

down_low – lower limit of a discrete signal failure, [mV];

down_hi – upper limit of a discrete signal failure, [mV];.

Explanation

Allows configuring the operating limits for the external power input

Example

Request:

PowInCfg 10,8000,15000,0,3000

Reply: POWINCFG:FiltLen=10,UpLow=8000,UpHi=15000,DownLow=0,DownHi=3000

Command format

AccVal

Parameters

Obtaining filtered accelerometer mean-square value by three axes.

Accelerometer sensitivity:

min = 555mV/g; average = 600mV/g; max = 645mV/g;

Where g is gravitational acceleration ($g \approx 9.8 \text{m/s}^2$).

Example

Request: AccVal

Reply: ACCVAL = 625

AccVal = 0.625B. As you can see, the accelerometer is affected only by the gravity force.

Transistor outputs setting

Command format

Out v,s

Parameters

v – output ordinal number (starting with the zero output);
s – desired state (0 – on-state transistor output;
1 – off-state transistor output).

Explanation

Transistor output control.

With one output being controlled, the others outputs' state remains unchanged.

Transistor outputs are off by default.

Example

Request: Out 1, 1

Reply: OUT(1..0) = 10

As you can see, all outputs except 1 are on.

Autoinformers setting

Command format

Autoinformers OnOff,Repeat,Out,FileName

Parameters

OnOff – enable/disable Autoinformers function: 1 – the function is enabled, 0 – the black box function is enabled (the navigation data are duplicated and saved to the external microSD card).

Repeat – determines whether the file should be replayed when the device is in the playback zone. If the value is 0, the file is played only once on entering the zone.

Out – output index, which is inverted during the audio file playing. 0 – no output is inverted, 1 – OUT0, 2 – OUT1, 3 – OUT2, 4 – OUT3, 5 – OUT4.

FileName – a route name. The route is understood as the number of zones to be announced.

Explanation

For more information, see section Autoinformers.

Example

Request: Autoinformers 1,0,0,Marshrut 1,50

Reply: AUTOINFORMER:OnOff=1,Repeat=0,Route=Marshrut 1;.

Digital inputs settings

Command format

RS2320 nf

Parameters

nf – function number

- 0 – no function on RS232;
- 1 – digital fuel level sensor (relative level N);
- 2 - digital fuel level sensor (frequency F);
- 3 – external GLONASS unit;
- 4 – Galileo photo camera
- 5 – Garmin navigator
- 6 – CAN-LOG
- 7 – CUB5 indicator
- 9 – RS232-RS485 adapter;
- 10 – REP-500 energy meter;
- 11 – Carrier DataCOLD500 temperature recorder;
- 12 – CI-5010A weight indicator;
- 13 – PressurePro;
- 14 – ThermoKing temperature recorder;
- 15 – EuroScan temperature recorder;
- 16 - Tenzo-M weight indicator;
- 17 – test of port performance;
- 18 – AWT 640 weight indicator.

Explanation

RS232 port function setting.

Example

Request: RS2320 1

Reply: RS232_0: NumFunc=1;

Command format

CUB5 N0

Parameters

N0 – parameter number displayed on the indicator connected to RS232 port.

Parameters:

- 0 – speed, accurate within 0.1, [km/h];
- 1 – directional angle accurate within 0.1 [°];
- 2 – external supply voltage [mV];
- 3 – internal accumulator voltage [mV];
- 4 – temperature inside the Terminal [°C];
- 5 – mileage according to the GPS/GLONASS data, accurate within 0.1, [km]
- 6 – input IN0;
- 7 – input IN1;
- 8 – input IN2;
- 9 – input IN3;
- 10 – RS232[0];
- 12 – temperature sensor 0 [°C];
- 13 – temperature sensor 1 [°C];
- 14 – temperature sensor 2 [°C];
- 15 – temperature sensor 3 [°C];
- 16 – temperature sensor 4 [°C];
- 17 – temperature sensor 5 [°C];
- 18 – temperature sensor 6 [°C];
- 19 – temperature sensor 7 [°C];
- 20 – CAN. Total fuel consumption [l]
- 21 – CAN. Tank fuel level, accurate within 0.1 [%]
- 22 – CAN. Coolant temperature [°C];
- 23 – CAN. Engine speed;
- 24 – CAN. mileage, accurate within 0.1 [km]
- 25-39 – CAN8BITR0 - CAN8BITR14;
- 40-44 – CAN16BITR0 – CAN16BITR4;
- 45-49 – CAN32BITR0 – CAN32BITR4;
- 50 – RS485[0];
- 51 – RS485[1];
- 52 – RS485[2].

Explanation

Settings of parameters display on the CUB5 indicator.

Example

Request: CUB5 1

Reply: CUB5:RS2320=1, RS2321=0;

Command format

DFilter RS2320

Parameters

RS2320 – filter length for a fuel level sensor connected to RS232 and RS485 ports, the number of successive sensor indications, which are averaged. If the value is equal to 1, there is no filtration.

Explanation

Digital fuel sensors indications filtering.

Example

Request: DFILTER 1,1,1,1,1,1,1,1,1,1,1,1,1,1,1,1

Reply:

DFILTER:RS232_0=1,RS232_1=1,RS485_0=1,RS485_1=1,RS485_2=1,RS485_3=1,RS485_4=1,RS485_5=1,RS485_6=1,RS485_7=1,RS485_8=1,RS485_9=1,RS485_10=1,RS485_11=1,RS485_12=1,RS485_13=1,RS485_14=1,RS485_15=1;

Command format

iButtons ib1,ib2,ib3,ib4,ib5,ib6,ib7,ib8

Parameters

ib1-ib8 – four lower bytes of iButton identification hexadecimal number without the checksum.

For example, full key hexadecimal number:

09 91 02 0C 00 00 00 5C, where

09 – type of device (in this case, it is DS1982, for DS1990 – 01),

91 02 0C 00 00 00 – unique number,

5C – the checksum.

In this case, 91 02 0C 00 must be entered.

Explanation

List of iButton identifiers, the connection state of which is monitored by the terminal.

Example

Request: iButtons 0091022C,0,0,0,0,0,0,0

Reply: IBUTTONS:0091022C,0,0,0,0,0,0,0

Command format

AddKey key1,...,key25

Parameters

key – the lower 4 bytes of the iButton identification number excluding the checksum in hexadecimal form.

For example, full key hexadecimal number:

09 91 02 0C 00 00 00 5C, where

09 – type of device (in this case, it is DS1982, for DS1990 – 01),

91 02 0C 00 00 00 – unique number,

5C – the checksum.

91 02 0C 00 must be entered.

The command can contain a list of up to 25 keys.

Explanation

To add keys to the list of trusted iButton identifiers on a microSD-card.

Example

Request: AddKey 0091022C,0091022D

Reply: Added 2 keys

Command format

DelKey key1,...,key25

Parameters

key – the lower 4 bytes of the iButton identification number excluding the checksum in hexadecimal form.

For example, full key hexadecimal number:

09 91 02 0C 00 00 00 5C, where

09 – type of device (in this case, it is DS1982, for DS1990 – 01),

91 02 0C 00 00 00 – unique number,

5C – the checksum.

91 02 0C 00 must be entered.

The command can contain a list of up to 25 keys.

Explanation

To remove keys from the list of trusted iButton identifiers on a microSD-card.

Example

Request: DelKey 0091022C,0091022D

Reply: Deleted 2 keys

Command format

KeyCount

Explanation

The number of trusted iButton keys on a microSD card.

Example

Request: KeyCount

Reply: KEYCOUNT:12;

Command format

ShowKey N

Parameters

N – The order number of an iButton key in the list on a microSD-card. Numbering starting with 1.

Explanation

To show an identifier of a trusted iButton key on a microSD-card.

Example

Request: ShowKey 1

Reply: SHOWKEY 1:9503276 (0x0091022C)

Command format

RS485FN nf

Parameters

nf – function number:

0 – fuel level sensors and digital Galileosky camera (old version); DBG-S11D, PressurePro gateway device;

1 – RFID reader MATRIX 5;

2 - fuel level sensors, Galileosky camera (current serial production), DBG-S11D, PressurePro gateway device.

Explanation

RS485 port settings.

Example

Request: RS485FN 1

Reply: RS485FN:1;

Command format

IBCFG T1,T2

Parameters

T1 – timeout from iButton detachment to setting to zero of the key code in the memory cell of the Terminal, for keys with the code of more or equal to 100000;

T2 – timeout from iButton detachment to setting to zero of the key code in the Terminal`s memory, for keys with the code of less than 100000.

Explanation

Periods settings of iButton keys codes setting to zero.

Example

Request: IBCFG 4,1500

Reply: IBCFG:Timeout=4,Timeout100000=1500;

Signaling mode setting

Command format

SIGN GWTime,DropAlarmTimeout,UseIB

Parameters

GWTime – duration of the "green wave" which is the time after the signalling starts, during which no sampling of sensors takes place, [sec];

DropAlarmTimeout – time in the alarm mode, after which an automatic switching to the alarm mode is performed. By zero, the Terminal will stay in the signalling mode until the command is sent or until it is switched off using the input, [sec];

UseIB – should iButton keys be used for arming and disarming:

- 0 – no;
- 1 – arming and disarming through the short-time put of one of the trusted iButton keys;
- 2 – arming only having one of the trusted iButton keys, if no key is put, the Terminal is disarmed;
- 3 – arming only having any of the iButton keys, if no key is put, the Terminal is disarmed.
- 4 – disarming only having any of the iButton keys, if no key is put, the Terminal is armed;
- 5 – arming through the short-time put of one of the trusted iButton keys, no disarming after disconnecting the key.
- 6 - arming if any iButton key is put. After disconnecting the key, the Terminal is armed.
- 7 – disarming, only having any of the iButton keys, if no key is put, the Terminal is armed;
- 8 - disarming through the short-time put of any iButton keys;

Explanation

General configurations of signalling.

Example

Request: SIGN 40,60,0

Reply: SIGN:GWTime=40,DropAlarmTimeout=60 ,UseIB=0;

Command format

S

Explanation

Arming.

Example

Request: S

Reply: Signaling is enabling

Command format

DS

Explanation

Disarming.

Example

Request: DS

Reply: Signaling is disabling

Command format

ST

Explanation

Signaling state. Possible states:

Signaling is disabled – signaling is off,

Signaling is enabled – signaling is on,

Alarm – alarm mode.

Example

Request: ST

Reply: Signaling is disabled.

Command format

AddSigPhone phone[,n]

Parameters

phone – a phone number.

n – an optional parameter, added phone number index.

Explanation

Notification phone setting

Example

Request: AddSigPhone 123456789

Reply: SignPhones 123456789;;;

Command format

SINO type,delay,sms,ring,photo,msg

Parameters

type – an input mode:

- 0 – is not used for signaling;
- 1 – input activation results in signaling mode on;
- 2 – input activation results in alert mode on if signaling mode is on;
- 3 – input activation results in alert mode on even if signaling mode is off.

delay – post-activation delay before switching to alert mode, [sec].

sms – enable SMS notification: 1 – yes, 0 – no

ring – enable phone call notification: 1 – yes, 0 – no

photo – take photo: 1 – yes, 0 – no

msg – alert mode message. The message may contain the parameters, which are replaced by the current data: %IMEI – IMEI of the terminal, %LAT – latitude, %LON – longitude.

Explanation

Setting the behavior of an input in signaling mode.

Example

Request: SINO 3,0,1,1,Alarm %IMEI

Reply: SINO:SignType=3,Adelay=0, SMS=1, Ring=1, Photo=0, Msg=Alarm %IMEI;

sin 1, sin2, sin3, sin4, sin5, sin6, sin7 commands are similar to sin0.

Command format

SGPS type,speed,r,t,sms,ring

Parameters

type – operating mode:

- 0 – is not used for signaling;
- 1 – switching to alert mode when the incline angle is exceeded;
- 2 – switching to alert mode if the speeding is exceeded (strike);
- 3 – switching to alert mode in case of incline or strike.

sms – enables SMS notification: 1 – yes, 0 – no

ring – enables phone call notification: 1 – yes, 0 – no

photo – enables making photos: 1 – yes, 0 – no

msg – a message sent in case of switching to alert mode. The following parameters are replaced by the following data in the message: %IMEI – terminal IMEI, %LAT – latitude, %LON – longitude.

Explanation

Setting of the use of GPS data in signaling mode

Example

Request: sgps 1,10,1,10,1,1

Reply: SGPS:SignType=1,Speed=10,R=1,T=10,SMS=0,Ring=0;

Command format

SACC type,sms,ring,photo,msg

Parameters

type – operating mode:

- 0 – is not used for signaling;
- 1 – an incline more than the given angle results in Alarm in Signaling mode;
- 2 – acceleration exceeding (strike) results in Alarm in Signaling mode;
- 3 – both an incline and a strike result in Alarm in Signaling mode.

sms – enables SMS notification: 1 – yes, 0 – no

ring – enables phone call notification: 1 – yes, 0 – no

photo – take photo: 1 – yes, 0 – no

msg – alert mode message. The message may contain the parameters, which are replaced by the current data: %IMEI – IMEI of the terminal, %LAT – latitude, %LON – longitude.

Explanation

Setting of the use of accelerometer data in signaling mode. Operation thresholds are set by SHOCK command (section [Determination of strike and incline](#))

Example

Request: SACC 2,1,1,0,Strike

Reply: SACC:SignType=2,SMS=1,Ring=1,Photo=0,Msg=Strike;

Command format

SOUT0 EMode,ElmpT,ElmpC,DMode,DlmpT,DlmpC,AMode,AlmpT,AlmpC,ADelay

Parameters

EMode – output operating mode by arming:

0 – no reaction,

1 – output is inverted,

2 – output generates pulses,

ElmpT – pulse time during Arming, m/sec.

ElmpC – number of pulses during Arming

DMode – output operating mode by Disarming

0 – no reaction,

1 – output is inverted,

2 – output generates pulses,

DlmpT – pulse time during Disarming, m/sec.

DlmpC – number of pulses during Disarming

AMode – output operating mode by Alarm:

0 – no reaction,

1 – output is inverted,

2 – output generates pulses,

AlmpT – pulse time during Alarm, m/sec.

AlmpC – number of pulses during Alarm.

ADelay – activation delay after Alarm mode is on.

The device rounds off pulse duration to 0.1 sec.

Explanation

Setting the behavior of an output in signaling mode.

Example

Request: SOUT0 2,1,1,2,2,2,1,0,1,20

Reply: SOUT0:EMode=2,ElmpT=1,ElmpC=1,DMode=2,DlmpT=2,DlmpC=2,

AMode=1,AlmpT=0,AlmpC=0,ADelay=20

sout1, sout2, sout3 commands are similar to sout0.

CAN settings

Command format

CanRegime Mode,BaudRate,TimeOut,DoNotCleanAfterTimeOut

Parameters

Mode – operating mode:

- 0 – CAN-interface is off and is not used;
- 1 – CAN-bus scanner (J1939_SCANNER mode);
- 2 – standard FMS filter (FMS mode);
- 3 – J1939 user filter 29 bit (J1939_USER_29bit mode);
- 4 – J1939 user filter 11 bit (J1939_USER_11bit mode);
- 5 – J1979 29bit identifiers (J1979_29bit mode);
- 6 – J1979 11 bit identifiers (J1979_11bit mode);
- 7 – J1979 detection of bus parameters (J1979_SCANNER mode);
- 8 – J1979 user filter 29 bit (J1979_USER_29bit mode);
- 9 – J1979 user filter 11 bit (J1979_USER_11bit mode);
- 10 – J1979 search for responded identifiers (J1979_CHECK_PIDS mode).

BaudRate – data bus rate. It must be the same as the vehicle data bus rate. It can have the following values: from 10000 up to 500000. Typical values: 62500, 125000, 250000, 500000.

TimeOut – measured in msec. For CAN_SCANNER mode it is response latency. If it is too small, not all bus messages will be received. The recommended time for CAN_SCANNER is 2000 msec. For all the rest modes it is time to receive at least one message, otherwise, the value will be set to zero.

DoNotCleanAfterTimeOut – data should not be set to zero by disconnecting CAN-bus.

Explanation

General CAN-bus control.

Example

Example: switching on scanner for a 250000 b/sec bus with the message (answer) latency, equal to 2 sec.

Request: CanRegime 1,250000,2000

Reply:CANREG:Mode=1,BaudRate=250000,TimeOut=2000;

DoNotCleanAfterTimeOut=0;

Command format

ActiveCAN OnOff

Parameters

OnOff – operating mode:

0 – passive mode: packets receiving confirmations are not sent to the CAN-bus. It is a safe mode of operation. It does not interfere with the on-board equipment;

1 – active mode: packets receiving confirmations are sent to the CAN-bus.

Explanation

Control of packets confirmation sending to the CAN-bus.

Confirmation sending may be necessary by connection to the troubleshooting socket if the data cannot be read in passive mode.

Example

Request: ActiveCAN 1

Reply: ACTIVECAN:1;

Command format

CAN8BitR0 ID,Shift,BigEndian

Parameters

ID – captured bus identifier:

Shift – useful data shift in the received packet

BigEndian – byte order, 0 – from the lower byte to the higher, 1 – from the higher to the lower.

Explanation

Single CAN-tag content control.

Example

Request: Can8BitR0 419360256,1,0

Reply: CAN8BITR0:ID=419360256,BigEndian=0;

Commands: **CAN8BitR1**, ..., **CAN8BitR30**, **CAN16BitR0**, ..., **CAN16BitR14**, **CAN32BitR0**, ..., **CAN32BitR14** are similar to **CAN8BitR0** command.

Packet transmission, energy saving, Stels mode settings

Command format: `Stels pday,phours, minutesGSMOn`. See section [Stels mode and packet transmission](#).

Photo camera operation settings

Command format

GetPhoto d,t,n

Parameters

d – photo date, format DDMMYY, where DD – day, MM – month, YY – year;

t – photo time, format HHMMSS, where HH – hours, MM – minutes, SS – seconds;

n – port number to which the camera taking photos is connected:

0 – RS232[0],

1 – RS232[1]

2 – RS485.

Explanation

Request to transmit the nearest to the given time and data photo to the server.

Example

Request: `GetPhoto 050511,052030,0`

Reply: Send of photo is scheduled

Command format

MakePhoto

Explanation

Take a photo and send it to the server

Example

Request: `MakePhoto`

Reply: Photo ok

User Manual Galileosky 5.1

Command format

PhotoCfg t1,t2,mode,res,confirm

Parameters

t1 –periodical shooting interval, [sec]. Photos are saved only to the SD-card, 0 – shooting only by event;

t2 – shooting interval [sec]. Photos are saved to the SD-card and sent to the server, 0 – shooting only by event;

mode – periodical shooting in geofences:

0 – photos are taken regardless of geofences;

1 – photos are taken only inside geofences;

2 – photos are taken only outside geofences.

res – picture resolution:

0 – 640x480 points;

1 – 320x240 points.

confirm – waiting for a confirmation of a picture reception from the server:

0 – do not wait;

1 – wait.

Explanation

Settings of a periodical camera shooting, picture format and image transfer protocol..

Example

Request: PhotoCfg 5,150,0,0,0

Reply: PHOTOCFG:WrPeriod=5,SendPeriod=150,Type=0,Size=0,Confirm=0;

Command format

CleanPhotoQueue n

Parameters

n – port number to which the camera taking photos is connected:

0 – RS232[0],

1 – RS232[1]

2 – RS485.

Explanation

Mark all photos as sent.

Example

Request: CleanPhotoQueue 0

Reply: Photo queue is cleaned

Bootloader

The processor program (firmware) is a set of algorithms developed by Galileosky Ltd specialists. Owing to this program, the central processor receives the data from different system units, processes them logically and mathematically and takes decisions for control commands of controller units to be worked out depending on the situation.

Bootloader is a Terminal`s sub-program allowing the main program part (hereinafter referred to as Firmware) being updated. The firmware can be downloaded from the official site www.galileosky.com.

The main program can be downloaded via the USB or GPRS channel in the Terminal.

USB channel download

Install Configurator for updating via USB-channel, after connecting the Terminal, select "Upgrade firmware".

GPRS channel download

- 1) Connect the Terminal to the external power supply;
- 2) APN settings must conform to the SIM-card inserted in the Terminal, otherwise, the device flashing will not happen, and the Terminal will return to the operating mode;

Give the following command: `UPGRADE firmwareNo` using any of the available channels (SMS, GPRS, USB), where firmwareN^o is the necessary firmware version. `UPGRADE 0` initiates downloading the latest firmware;

- 3) You may see if the flashing is in progress by LEDs blinking;
- 4) In 15-25 minutes (depending on connection conditions and GPRS terms of service by operator) upgrade will be completed, and the Terminal will turn into operation mode automatically.

Using analog inputs to enter bootloader mode

After the device power supply is off, energize all analog-discrete inputs (section [Contacts description](#)) by applying the voltage of $7.0V \pm 0.2V$ until the Terminal enters the bootloader mode. This function is used only during an improper device flashing. An improper firmware is the firmware designed for terminals with the other functional.

LED operation during reflashing

Depending on the GSM/3G-modem and microcontroller units activation stages, the Terminal will go through the following stages:

Yellow LED blinking, times	GSM/3G-modem activation stage
6	Procedure of GSM/3G-unit activation was successful.
5	GPRS/3G-service registration was successful.
4	Firmware update connection to the server.
3	The Terminal switched to downloading mode.
2	Server connection is not lost, and the Terminal is in downloading mode.
1	First request sending was successful.

Blue LED blinking: each successfully received and recorded packet is accompanied by a blue LED light change.

Galileosky Protocol Data

Bit number is entered in mainpackbit and headpackbit commands for selecting parameters, transmitted to the server.

Bit №	Description
1	Hardware version
2	Firmware version
3	IMEI
4	Device's identifier
5	Number of an archive record
6	Greenwich date and time
7	Coordinates in degrees, number of satellites, indication of coordinates determination correctness
8	Speed in km/h and direction in degrees
9	Height, m
10	HDOP
11	Status of device
12	Supply voltage, mV
13	Battery voltage, mV
14	Terminal temperature, °C
15	Acceleration
16	Status of outputs
17	Status of inputs
18	Input voltage 0, mV Depending on settings: <ol style="list-style-type: none"> 1. voltage, mV; 2. number of impulses; 3. frequency, Hz.
19	Input voltage 1, mV Depending on settings: <ol style="list-style-type: none"> 1. voltage, mV; 2. number of impulses; 3. frequency, Hz.
20	Input voltage 2, mV Depending on settings: <ol style="list-style-type: none"> 1. voltage, mV; 2. number of impulses; 3. frequency, Hz.

Bit №	Description
21	Input voltage 3, mV Depending on settings: 1. voltage, mV; 2. number of impulses; 3. frequency, Hz.
22	RS232 0
24	Thermometer 0 identifier and measured temperature, °C
25	Thermometer 1 identifier and measured temperature, °C
26	Thermometer 2 identifier and measured temperature, °C
27	Thermometer 3 identifier and measured temperature, °C
28	Thermometer 4 identifier and measured temperature, °C
29	Thermometer 5 identifier and measured temperature, °C
30	Thermometer 6 identifier and measured temperature, °C
31	Thermometer 7 identifier and measured temperature, °C
32	iButton first key identification number
33	CAN-bus (CAN_A0) and CAN-LOG data. Fuel used by a vehicle from the date of manufacturing, l.
34	CAN-bus (CAN_A1) and CAN-LOG data; Fuel level, %; Temperature of coolant °C; Engine speed, rotations/min.
35	CAN-bus (CAN_B0) and CAN-LOG data. Vehicle`s mileage, m.
36	CAN_B1
37	CAN8BITR0 Or vehicle speed from CAN-LOG, km/h
38	CAN8BITR1 or the 3 rd byte of prefix S CAN-LOG
39	CAN8BITR2 or the 2 nd byte of prefix S CAN-LOG
40	CAN8BITR3 or lower byte of prefix S CAN-LOG
41	CAN8BITR4 or the 3 rd byte of prefix P CAN-LOG
42	CAN8BITR5 or the 2 nd byte of prefix P CAN-LOG
43	CAN8BITR6 or the 1 st byte of prefix P CAN-LOG
44	CAN8BITR7 or lower byte of prefix P CAN-LOG
45	CAN8BITR8 or higher byte of prefix WA CAN-LOG
46	CAN8BITR9 or 4 th byte of prefix WA CAN-LOG
47	CAN8BITR10 or 3 rd byte of prefix WA CAN-LOG
48	CAN8BITR11 or 2 nd byte of prefix WA CAN-LOG
49	CAN8BITR12
50	CAN8BITR13
51	CAN8BITR14
52	Second iButton key identification number
53	Total mileage according to GPS/GLONASS units, m.
54	State of iButton keys, identifiers of which are set by iButtons command.

Bit №	Description
55	Depending on settings: 1. CAN16BITR0 2. the 1st vehicle`s axle load, kg 3. failure code OBD II
56	Depending on settings: 1. CAN16BITR1 2. the 2 nd vehicle`s axle load, kg 3. failure code OBD II
57	Depending on settings: 1. CAN16BITR2 2. the 3 rd vehicle`s axle load, kg 3. failure code OBD II
58	Depending on settings: 1. CAN16BITR3 2. the 4 st vehicle`s axle load, kg 3. failure code OBD II
59	Depending on settings: 1. CAN16BITR4 2. the 5 th vehicles axle load, kg 3. failure code OBD II
60	Depending on settings: 1. CAN32BITR0 2. total time of engine operation, h.
61	Depending on settings: 1. CAN32BITR1 2. CAN-LOG, R prefix, fuel level, l
62	Depending on settings: 1. CAN32BITR2 2. CAN-LOG, user`s prefix
63	Depending on settings: 1. CAN32BITR3 2. CAN-LOG, user`s prefix
64	Depending on settings: 1. CAN32BITR4 2. CAN-LOG, user`s prefix
65	Input voltage 4. Depending on settings: 1. voltage, mV; 2. number of impulses; 3. frequency, Hz.
66	Input voltage 5. Depending on settings: 1. voltage, mV; 2. number of impulses; 3. frequency, Hz.

Bit №	Description
67	Input voltage 6. Depending on settings: 1. voltage, mV; 2. number of impulses; 3. frequency, Hz.
68	Input voltage 7. Depending on settings: 1. voltage, mV; 2. number of impulses; 3. frequency, Hz.
69	Zero DS1923 sensor Identifier, measured temperature °C and humidity %.
70	The 1 st DS1923 sensor Identifier, measured temperature °C and humidity %.
71	The 2 nd DS1923 sensor Identifier, measured temperature °C and humidity %.
72	The 3 rd DS1923 sensor Identifier, measured temperature °C and humidity %.
73	The 4 th DS1923 sensor Identifier, measured temperature °C and humidity %.
74	The 5 th DS1923 sensor Identifier, measured temperature °C and humidity %.
75	The 6 th DS1923 sensor Identifier, measured temperature °C and humidity %.
76	The 7 th DS1923 sensor Identifier, measured temperature °C and humidity %.
77	RS485. A value from fuel level sensor with address 0.
78	RS485. A value from fuel level sensor with address 1.
79	RS485. A value from fuel level sensor with address 2.
80	RS485. Fuel level sensor with address 3. Relative fuel level and temperature. RS485. Fuel level sensor with addresses 4-14, with numbers 81-91. Relative fuel level and temperature.
93	Extended data RS232[0]. Depending on settings: 1. Temperature from fuel level sensors connected to zero RS232 port, °C. 2. Weight, received from weight indicator.
95	RS485. Temperature from fuel level sensor with address 0, °C.
96	RS485. Temperature from fuel level sensor with address 1, °C.
97	RS485. Temperature from fuel level sensor with address 2, °C.
129	CAN8BITR15 Tags CAN8BITR16 - CAN8BITR29 similar to CAN8BITR16 with numbers 130-143
144	CAN8BITR30
145	CAN16BITR5 Tags CAN16BITR6 – CAN16BITR13 similar to CAN16BITR5 with numbers 146-153
154	CAN16BITR14
161	CAN32BITR5 Tags CAN32BITR6 – CAN32BITR13 similar to CAN32BITR5 with numbers 162-169
170	CAN32BITR14
171	REP-500 electricity meter readings
173	Refrigeration unit data
174	EcoDrive and driving style determination
175	PressurePro tires pressure monitoring system, 34 sensors

Additional Information

Certifying

The Terminal is certified to comply with GOST R.

Warranty

RSA "Galileosky", LLC hereby guarantees the realization of consumers' rights provided by the local laws throughout Russia and the CIS.

RSA "Galileosky", LLC guarantees the operability of the terminal subject to compliance with the instructions set out in the above user's manual.

Warranty conditions

The warranty period is 24 months since the day of purchase.

Note: a defective terminal (with cracks and fissures, dents and impact marks and etc.) due to consumer's fault resulting from inappropriate maintenance, storage and transportation is not liable to warranty.

The above also holds for a device without the body or battery.

In case the guarantee document proving the device sale to the customer does not contain the date of purchase, the name and seller's seal, the warranty period starts since the day of production.

The consumer has the right for free maintenance in the manufacturer's service center if a production or design defect appeared during the warranty period. The consumer has the right for maintenance during the whole period of operation of the device. The consumer has all the other rights provided by the laws of the Russian Federation and the CIS.

If the failure cause cannot be found at the moment of appeal, a technical examination is held, which cannot exceed 30 days since the moment of appeal.

The warranty does not apply in case of:

- Inappropriate transportation, storage or maintenance, described in User's Manual;
- Unauthorised opening the device during the warranty period;
- Repairing controlled by someone or some organization not authorised by Galileosky during the warranty period;
- Signs of electrical and/or other damage due to prohibitive mains parameter changes, misapplication and neglect of the device;
- Physical damage of the device body and board, SIM holder, aerials or wires break;
- Traces of oxidation of outer and inner parts or exposure of the device body to moisture;
- Theft or criminal damage of the external aerial or cable;
- Damages caused by foreign objects, substances, liquids, insects coming into body;
- Damage caused by exposure to high temperature or intense microwave radiation;
- Damage caused by elemental forces, fire, social factors, random external factors and accidents;

User Manual Galileosky 5.1

- Damage caused by parameters incompatibility or inappropriate attachment of additional devices or sensors to the terminal;
- Operation of the terminal by the vehicle network voltage deviating from the range mentioned in technical specifications.
- Damages caused by incorrect installation of the Terminal to the vehicle;
- Failure in Terminal's operating due to incompatibility of software version and Terminal version.
- Connection socket, contacts and SIM-holders are not covered under warranty.
- Warranty period for aerials – 6 (six) calendar months from the moment of realization note in device passport, but not more than 8 (eight) calendar months from the moment of device shipping to the Buyer from the Manufacturer storage included in delivery note.
- Warranty period for a processor, GSM module, GLONASS/GPS module – 34 (thirty-four) calendar months from the moment of realization note in device passport, but not more than 36 (thirty-six) calendar months from the moment of device shipping to the Buyer from the Manufacturer storage included in delivery note.

ATTENTION! The manufacturer shall in no case be liable for claims concerning the damage or loss of the data exceeding the cost of the product, as well as claims for incidental, special or consequential damages (including in each case, without limitation, damages for inability to use the equipment, loss of the data, loss of business, loss of profit, loss of savings, loss of time), arising out of the use or inability to use the equipment within legal limits.

ATTENTION! The Warranty does not affect the statutory rights of the consumer, such as the guarantee of satisfactory quality of work or conformity of the product to the purpose for which analogous products are used under normal conditions and service maintenance and also your rights with regard to the seller of the product resulting from the fact of purchase and contract of sale and purchase.

ATTENTION! Terms of Warranty service, which are in conflict with the current law, have no legal effect and are subject to the current law.

ATTENTION! If the Purchaser fails to comply with the Terms of Warranty, the validity of the Warranty is void.

Contacts of Galileosky Technical Support Team
+7 (499) 704 47 99; +7 (342) 270 07 99 add. 2
e-mail: support@7gis.ru