



FMB920 User Manual

V0.30

Table of contents

| | | |
|----------|---|-----------|
| 1 | INTRODUCTION | 9 |
| 1.1 | ATTENTION..... | 9 |
| 1.2 | INSTRUCTIONS OF SAFETY | 9 |
| 1.3 | LEGAL NOTICE | 10 |
| 1.4 | ABOUT DOCUMENT | 10 |
| 2 | BASIC DESCRIPTION | 10 |
| 2.1 | BASIC CHARACTERISTICS | 11 |
| 2.2 | TECHNICAL FEATURES..... | 12 |
| 2.3 | TECHNICAL INFORMATION ABOUT INTERNAL BATTERY..... | 13 |
| 2.4 | ELECTRICAL CHARACTERISTICS..... | 14 |
| 2.5 | ABSOLUTE MAXIMUM RATINGS..... | 14 |
| 3 | CONNECTION, PINOUT, ACCESSORIES..... | 15 |
| 3.1 | HOW TO INSERT SIM CARD INTO FMB920 DEVICE: | 15 |
| 3.2 | HOW TO ADD MICROSD CARD INTO FMB9XX DEVICE | 15 |
| 3.3 | INSTALLING FMB920 DRIVERS | 16 |
| 3.4 | ACCESSORIES..... | 18 |
| 3.5 | TERMINAL LOG FOR FMB DEVICES..... | 20 |
| 3.6 | NAVIGATE LED..... | 21 |
| 3.7 | STATUS LED | 21 |
| 4 | OPERATIONAL BASICS..... | 22 |
| 4.1 | OPERATIONAL PRINCIPALS..... | 22 |
| 4.2 | SLEEP MODES | 22 |
| 4.2.1 | <i>GPS Sleep mode</i> | <i>22</i> |
| 4.2.2 | <i>Deep Sleep mode</i> | <i>22</i> |
| 4.2.3 | <i>Online Deep Sleep mode.....</i> | <i>23</i> |
| 4.3 | VIRTUAL ODOMETER..... | 23 |
| 4.4 | FEATURES..... | 24 |
| 4.4.1 | <i>ECO driving/Green driving Scenarios.....</i> | <i>24</i> |
| 4.4.2 | <i>Over Speeding Scenario.</i> | <i>25</i> |
| 4.4.3 | <i>Jamming detection</i> | <i>25</i> |
| 4.4.4 | <i>Trip.....</i> | <i>25</i> |
| 4.4.5 | <i>DOUT Control Via Call.....</i> | <i>25</i> |
| 4.5 | GPS FUEL CONSUMPTION | 26 |
| 4.6 | SCENARIOS ACCELEROMETER..... | 26 |
| 4.6.1 | <i>Excessive Idling</i> | <i>26</i> |
| 4.6.2 | <i>Unplug Detection.....</i> | <i>26</i> |
| 4.6.3 | <i>Towing Detection.....</i> | <i>26</i> |
| 4.6.4 | <i>Crash Detection</i> | <i>26</i> |
| 4.7 | BLUETOOTH..... | 26 |
| 5 | CONFIGURATION | 27 |
| 5.1 | CONFIGURATOR..... | 27 |
| 5.1.1 | <i>Main Buttons description:</i> | <i>28</i> |
| 5.1.2 | <i>Keyword SMS (GPRS) commands:</i> | <i>28</i> |
| 5.1.3 | <i>Keyword configuration with TCP</i> | <i>29</i> |
| 5.2 | STATUS INFO | 29 |
| 5.3 | SECURITY INFO | 29 |
| 5.4 | SYSTEM SETTINGS..... | 30 |
| 5.5 | RECORDS SETTINGS..... | 32 |
| 5.6 | GSM SETTINGS, GPRS PART..... | 32 |
| 5.7 | GPRS AUTHENTICATION | 33 |

| | | |
|----------|---|-----------|
| 5.8 | GSM SETTINGS, SMS/CALL PART | 33 |
| 5.9 | GSM OPERATORS, ROAMING OPERATOR LIST, BLACKLIST OPERATOR LIST | 35 |
| 5.10 | DATA ACQUISITION MODE SETTINGS | 36 |
| 5.11 | FEATURES SETTINGS..... | 39 |
| 5.11.1 | <i>Green Driving</i> | 39 |
| 5.11.1.1 | Data output..... | 40 |
| 5.11.1.2 | Auto Calibaration..... | 41 |
| 5.11.2 | <i>Over Speeding</i> | 41 |
| 5.11.3 | <i>Excessive Idling</i> | 41 |
| 5.11.4 | <i>Jamming</i> | 41 |
| 5.11.5 | <i>Use authorized numbers to control DOUT via call</i> | 42 |
| 5.11.6 | <i>Trip settings</i> | 42 |
| 5.11.7 | <i>DOUT control depending on functionality priority</i> | 44 |
| 5.12 | AUTOGEOFENCING SETTINGS | 45 |
| 5.13 | MANUAL GEOFENCE..... | 46 |
| 5.14 | GPS FUEL COUNTER..... | 47 |
| 5.15 | SCENARIOS ACCELEROMETER..... | 48 |
| 5.15.1 | <i>Unplug Detection</i> | 48 |
| 5.15.2 | <i>Towing Detection</i> | 48 |
| 5.15.3 | <i>Crash Detection</i> | 49 |
| 5.16 | BLUETOOTH..... | 51 |
| 5.16.1 | <i>General functionality</i> | 51 |
| 5.17 | HOW TO CONNECT BLUETOOTH HANDS FREE ADAPTER TO FMB DEVICE..... | 53 |
| 5.17.1 | <i>Bluetooth settings configuration</i> | 53 |
| 5.17.2 | <i>Connecting Bluetooth Hands Free adapter</i> | 55 |
| 5.18 | DEVICE'S LOG USING YOUR MOBILE PHONE..... | 55 |
| 5.19 | DEVICE DEBUG OVER ANDROID SMARTPHONE..... | 56 |
| 5.20 | HOW TO CONNECT OBD II BLUETOOTH DONGLE TO FMB DEVICE..... | 58 |
| 5.20.1 | <i>Bluetooth settings configuration</i> | 58 |
| 5.20.2 | <i>Connecting to Bluetooth OBD II dongle</i> | 59 |
| 5.20.3 | <i>Supported Bluetooth OBD II dongles</i> | 60 |
| 5.21 | SMS EVENTS..... | 60 |
| 5.22 | I/O SETTINGS | 62 |
| 5.22.1 | <i>Operand On Exit</i> | 62 |
| 5.22.2 | <i>Operand On Entrance</i> | 63 |
| 5.22.3 | <i>Operand On Both</i> | 63 |
| 5.22.4 | <i>Operand Monitoring</i> | 63 |
| 5.22.5 | <i>Operand On Hysteresis</i> | 63 |
| 5.22.6 | <i>Operand On Change</i> | 64 |
| 5.22.7 | <i>Operand On Delta Change</i> | 64 |
| 5.22.8 | <i>Avg const (Averaging parameter description)</i> | 64 |
| 5.23 | ALL I/O ELEMENTS DESCRIPTION | 65 |
| 5.23.1 | <i>Permaement I/O elements</i> | 65 |
| 6 | SMS COMMAND LIST | 66 |
| 6.1 | SMS COMMAND LIST..... | 66 |
| 6.1.1 | <i>getinfo</i> | 68 |
| 6.1.2 | <i>getver</i> | 69 |
| 6.1.3 | <i>getstatus</i> | 69 |
| 6.1.4 | <i>getgps</i> | 69 |
| 6.1.5 | <i>getio</i> | 70 |
| 6.1.6 | <i>ggps</i> | 70 |
| 6.1.7 | <i>radio #</i> | 70 |
| 6.1.8 | <i>getparam</i> | 70 |
| 6.1.9 | <i>setparam</i> | 70 |
| 6.1.10 | <i>flush #,#,#,#,#,#</i> | 70 |
| 6.1.11 | <i>countrecs</i> | 71 |
| 6.1.12 | <i>deleterecords</i> | 71 |

| | | |
|----------|---|-----------|
| 6.1.13 | <i>setdigout</i> | 71 |
| 6.1.14 | <i>battery</i> | 71 |
| 6.1.15 | <i>fc_reset</i> | 72 |
| 6.1.16 | <i>towingreact</i> | 72 |
| 6.1.17 | <i>odoset:#</i> | 72 |
| 6.1.18 | <i>odoget</i> | 72 |
| 6.1.19 | <i>btgetlist #</i> | 72 |
| 6.1.20 | <i>obdinfo</i> | 72 |
| 6.1.21 | <i>faultcodes</i> | 72 |
| 6.1.22 | <i>setkey # #</i> | 73 |
| 6.1.23 | <i>delkey # #</i> | 73 |
| 6.1.24 | <i>bbread #</i> | 73 |
| 6.1.25 | <i>bbinfo #</i> | 73 |
| 6.1.26 | <i>sdformat</i> | 73 |
| 7 | PARAMETER LIST | 73 |
| 7.1 | SYSTEM PARAMETERS | 73 |
| 7.1.1 | <i>Sleep Mode (ID=102)</i> | 73 |
| 7.1.2 | <i>Sleep timeout (ID=103)</i> | 74 |
| 7.1.3 | <i>Movement Source (ID=100)</i> | 74 |
| 7.1.4 | <i>Static Navigation (ID=106)</i> | 74 |
| 7.1.5 | <i>Static Navigation Settings (ID=112)</i> | 74 |
| 7.1.6 | <i>Saving/Sending without time synchronization (ID=107)</i> | 75 |
| 7.1.7 | <i>GNSS Source (ID=109)</i> | 75 |
| 7.1.8 | <i>Ignition settings (ID=101)</i> | 75 |
| 7.1.9 | <i>High voltage level (ID=104)</i> | 76 |
| 7.1.10 | <i>Low voltage level (ID=105)</i> | 76 |
| 7.1.11 | <i>Movement Start Delay(s) (ID=19001)</i> | 76 |
| 7.1.12 | <i>Movement Stop Delay(s) (ID=19002)</i> | 76 |
| 7.1.13 | <i>Led indication (ID=108)</i> | 77 |
| 7.1.14 | <i>Synchronization settings (ID=900)</i> | 77 |
| 7.1.15 | <i>NTP Resync (ID=901)</i> | 77 |
| 7.1.16 | <i>NTP server 1 (ID=902)</i> | 77 |
| 7.1.17 | <i>NTP server 2 (ID=903)</i> | 77 |
| 7.1.18 | <i>Battery charge mode (ID=110)</i> | 78 |
| 7.2 | RECORDS PARAMETERS | 78 |
| 7.2.1 | <i>Sorting (ID=1002)</i> | 78 |
| 7.2.2 | <i>Open Link Timeout (ID=1000)</i> | 78 |
| 7.2.3 | <i>Server Response Timeout (ID=1001)</i> | 78 |
| 7.3 | GPRS PARAMETERS | 79 |
| 7.3.1 | <i>GPRS content activation (ID=2000)</i> | 79 |
| 7.3.2 | <i>APN Name (ID=2001)</i> | 79 |
| 7.3.3 | <i>APN username (ID=2002)</i> | 79 |
| 7.3.4 | <i>APN Password (ID=2003)</i> | 79 |
| 7.3.5 | <i>Domain (ID=2004)</i> | 80 |
| 7.3.6 | <i>Target Server Port (ID=2005)</i> | 80 |
| 7.3.7 | <i>Protocol (ID=2006)</i> | 80 |
| 7.3.8 | <i>Backup Server Domain (ID=2007)</i> | 80 |
| 7.3.9 | <i>Backup Server Port (ID=2008)</i> | 80 |
| 7.3.10 | <i>Backup Server Protocol (ID=2009)</i> | 81 |
| 7.3.11 | <i>Backup Server Mode (ID=2010)</i> | 81 |
| 7.3.12 | <i>GPRS Authentication parameters (ID=2016)</i> | 81 |
| 7.4 | SMS/CALL SETTINGS | 81 |
| 7.4.1 | <i>SMS data sending settings (ID=3000)</i> | 81 |
| 7.4.2 | <i>Data send number (ID=3001)</i> | 81 |
| 7.4.3 | <i>Authorized phone numbers (ID=4000-4009)</i> | 82 |
| 7.4.4 | <i>GSM Predefined Numbers (ID=6000-6009)</i> | 82 |
| 7.4.5 | <i>SMS Login (ID=3003)</i> | 82 |

| | | |
|----------|---|----|
| 7.4.6 | SMS Password (ID=3004)..... | 83 |
| 7.4.7 | Incoming call action (ID=3005)..... | 83 |
| 7.4.8 | SMS Event Time Zone (ID=3006)..... | 83 |
| 7.4.9 | Hands Free Call Settings (ID=3007) | 83 |
| 7.4.10 | GSM number index (ID=3008) | 83 |
| 7.4.11 | Roaming Operator List (ID=5000-5049) | 84 |
| 7.4.12 | Black List (ID=5500-5549)..... | 84 |
| 7.5 | DATA ACQUISITION MODES PARAMETERS..... | 84 |
| 7.5.1 | Home Network GSM operator code "Vehicle on STOP" parameters..... | 84 |
| 7.5.1.1 | Min Period (ID=10000)..... | 84 |
| 7.5.1.2 | Min Saved Records (ID=10004)..... | 84 |
| 7.5.1.3 | Send Period (ID=10005)..... | 84 |
| 7.5.2 | Home Network GSM operator code "Vehicle MOVING" parameters..... | 85 |
| 7.5.2.1 | Min Period (ID=10050)..... | 85 |
| 7.5.2.2 | Min Distance (ID=10051) | 85 |
| 7.5.2.3 | Min Angle (ID=10052)..... | 85 |
| 7.5.2.4 | Min Speed Delta (ID=10053)..... | 86 |
| 7.5.2.5 | Min Saved Records (ID=10054)..... | 86 |
| 7.5.2.6 | Send Period (ID=10055)..... | 86 |
| 7.5.3 | Roaming Network GSM operator code "Vehicle on STOP" parameters..... | 86 |
| 7.5.3.1 | Min Period (ID=10100)..... | 86 |
| 7.5.3.2 | Min Saved Records (ID=10104)..... | 87 |
| 7.5.3.3 | Send Period (ID=10105)..... | 87 |
| 7.5.4 | Roaming Network GSM operator code "Vehicle MOVING" parameters..... | 87 |
| 7.5.4.1 | Min Period (ID=10150)..... | 87 |
| 7.5.4.2 | Min Distance (ID=10151) | 87 |
| 7.5.4.3 | Min Angle (ID=10152)..... | 88 |
| 7.5.4.4 | Min Speed Delta (ID=10153)..... | 88 |
| 7.5.4.5 | Min Saved Records (ID=10154)..... | 88 |
| 7.5.4.6 | Send Period (ID=10155)..... | 88 |
| 7.5.5 | Unknown Network GSM operator code "Vehicle on STOP" parameters..... | 89 |
| 7.5.5.1 | Min Period (ID=10200)..... | 89 |
| 7.5.5.2 | Min Saved Records (ID=10204)..... | 89 |
| 7.5.5.3 | Send Period (ID=10205)..... | 89 |
| 7.5.6 | Unknown Network GSM operator code "Vehicle MOVING" parameters..... | 89 |
| 7.5.6.1 | Min Period (ID=10250)..... | 89 |
| 7.5.6.2 | Min Distance (ID=10251) | 90 |
| 7.5.6.3 | Min Angle (ID=10252)..... | 90 |
| 7.5.6.4 | Min Speed (ID=10253)..... | 90 |
| 7.5.6.5 | Min Saved Records (ID=10254)..... | 90 |
| 7.5.6.6 | Send Period (ID=10255)..... | 91 |
| 7.6 | FEATURES PARAMETERS..... | 91 |
| 7.6.1 | Green driving parameters..... | 91 |
| 7.6.1.1 | Green driving priority (ID=11000)..... | 91 |
| 7.6.1.2 | Max Acceleration Force (ID=11004) | 91 |
| 7.6.1.3 | Max Braking Force (ID=11005)..... | 92 |
| 7.6.1.4 | Max Cornering (ID=11006)..... | 92 |
| 7.6.1.5 | Green/Eco driving (ID=11007) | 93 |
| 7.6.1.6 | Green Driving Duration (ID=11008) | 93 |
| 7.6.1.7 | Green driving digital output control settings (ID=11003) | 94 |
| 7.6.1.8 | Green driving Digital output on duration (ID=11001)..... | 94 |
| 7.6.1.9 | Green driving Digital output off duration (ID=11002) | 95 |
| 7.6.1.10 | Green driving Send SMS to (ID=7034) | 95 |
| 7.6.1.11 | Green driving SMS text (ID=8034) | 96 |
| 7.6.2 | Overspeeding scenario parameters..... | 96 |
| 7.6.2.1 | Overspeeding priority (ID=11100) | 96 |
| 7.6.2.2 | Max allowed Speed (ID=11104) | 97 |
| 7.6.2.3 | Overspeeding output control (ID=11103)..... | 97 |
| 7.6.2.4 | Overspeeding Digital output on duration (ID=11101) | 97 |
| 7.6.2.5 | Overspeeding Digital output off duration (ID=11102) | 98 |
| 7.6.2.6 | Overspeeding Send SMS To (ID=7032) | 98 |
| 7.6.2.7 | Overspeeding SMS Text (ID=8032) | 98 |

| | | |
|----------|--|-----|
| 7.6.3 | <i>Jamming scenario parameters</i> | 99 |
| 7.6.3.1 | Jamming priority (ID=11300) | 99 |
| 7.6.3.2 | Jamming Eventual records (ID=11303) | 99 |
| 7.6.3.3 | Jamming Output Control (ID=11304)..... | 100 |
| 7.6.3.4 | Time Until Jamming Event Detection(ID=11305)..... | 100 |
| 7.6.3.5 | Jamming DOUT on duration [ms] (ID=11301)..... | 100 |
| 7.6.3.6 | Jamming DOUT off duration [ms] (ID=11302) | 101 |
| 7.6.4 | <i>Trip scenario parameters</i> | 101 |
| 7.6.4.1 | Trip priority (ID=11800) | 101 |
| 7.6.4.2 | Eventually Records (ID=11801) | 101 |
| 7.6.4.3 | Trip mode (ID=11802)..... | 102 |
| 7.6.4.4 | Start Speed (ID=11803)..... | 102 |
| 7.6.4.5 | Ignition Off Timeout (ID=11804)..... | 102 |
| 7.6.4.6 | Eco Score allowed events (ID=700)..... | 103 |
| 7.6.4.7 | Trip Send SMS To (ID=7031) | 103 |
| 7.6.4.8 | Trip SMS Text (ID=8031) | 103 |
| 7.6.4.9 | Odometer distance calculation source (ID=11806) | 104 |
| 7.6.4.10 | Total Odometer value (11807)..... | 104 |
| 7.6.5 | <i>DOUT control via call scenario parameters</i> | 104 |
| 7.6.5.1 | Digital Output control (ID=12000) | 104 |
| 7.6.5.2 | DOUT deactivation (ID=12001) | 104 |
| 7.6.5.3 | Duration timeout (ID=12002) | 105 |
| 7.7 | AUTOGEOFENCING SCENARIO PARAMETERS | 105 |
| 7.7.1 | <i>AutoGeofencing priority (ID=20000)</i> | 105 |
| 7.7.2 | <i>Eventual Records (ID=20002)</i> | 105 |
| 7.7.3 | <i>Activation Timeout (ID=20003)</i> | 106 |
| 7.7.4 | <i>Deactivate by (ID=20005)</i> | 106 |
| 7.7.5 | <i>AutoGeofence event generating (ID=20001)</i> | 106 |
| 7.7.6 | <i>Radius (ID=20004)</i> | 107 |
| 7.7.7 | <i>AutoGeofence Send SMS to (ID=7030)</i> | 107 |
| 7.7.8 | <i>SMS Text (ID=8030)</i> | 107 |
| 7.8 | MANUAL GEOFENCE | 108 |
| 7.8.1 | <i>First Geozone parameters</i> | 108 |
| 7.8.1.1 | #1 Geozone Manual Geofencing priority (ID=20100) | 108 |
| 7.8.1.2 | #1 Geozone Manual Geofence event generating (ID=20101)..... | 108 |
| 7.8.1.3 | #1 Geozone Eventual Records (ID=20102)..... | 109 |
| 7.8.1.4 | #1 Geozone Frame border (ID=20103) | 109 |
| 7.8.1.5 | #1 Geozone Shape type (ID=20104) | 110 |
| 7.8.1.6 | #1 Geozone Radius (ID=20105)..... | 110 |
| 7.8.1.7 | #1 Geozone X1 (ID=20106) | 111 |
| 7.8.1.8 | #1 Geozone Y1 (ID=20107) | 111 |
| 7.8.1.9 | #1 Geozone X2 (ID=20108) | 112 |
| 7.8.1.10 | #1 Geozone X1 (ID=20109) | 112 |
| 7.8.1.11 | #1 Geozone OverSpeeding (ID=20110)..... | 113 |
| 7.8.1.12 | #1 Geozone Max allowed speed (ID=20111) | 113 |
| 7.8.2 | <i>Other Geozones</i> | 114 |
| 7.8.2.1 | Send sms to #1-5 Geozone (ID=7025-7029), #6-50 Geozone (ID=7071-7115)..... | 114 |
| 7.8.2.2 | SMS Text #1-5 Geozone (ID=8025-8029), #6-50 Geozone (ID=8071-8115) | 114 |
| 7.9 | GPS FUEL COUNTER | 115 |
| 7.9.1 | <i>City Consumption L/100km (ID=11900)</i> | 115 |
| 7.9.2 | <i>Highway Consumption L/100km (ID=11901)</i> | 115 |
| 7.9.3 | <i>Average Consumption L/100km (ID=11902)</i> | 116 |
| 7.9.4 | <i>City Speed [km/h] (ID=11903)</i> | 116 |
| 7.9.5 | <i>Highway Speed [km/h] (ID=11904)</i> | 117 |
| 7.9.6 | <i>Average Speed [km/h] (ID=11905)</i> | 117 |
| 7.9.7 | <i>Correction coefficient (ID=11906)</i> | 118 |
| 7.9.8 | <i>Fuel Consumption on Idling [L/h] (ID=11907)</i> | 118 |
| 7.9.9 | <i>Higher Speeds Add [%] (ID=11908)</i> | 119 |
| 7.9.10 | <i>Highway Consumption every km/h (ID=11909)</i> | 119 |
| 7.10 | SCENARIOS ACCELEROMETER | 120 |
| 7.10.1 | <i>Unplug Detection</i> | 120 |

| | | |
|-----------|--|-----|
| 7.10.1.1 | Scenario settings (ID=11500) | 120 |
| 7.10.1.2 | Eventual records (ID=11501) | 120 |
| 7.10.1.3 | Unplug detection mode (ID=11502) | 120 |
| 7.10.1.4 | Unplug send sms to (ID=7067) | 120 |
| 7.10.1.5 | SMS Text (ID=8067) | 121 |
| 7.10.2 | <i>Towing Detection</i> | 121 |
| 7.10.2.1 | Scenario setting (ID=11600) | 121 |
| 7.10.2.2 | Eventual Records (ID=11601) | 121 |
| 7.10.2.3 | Activation Timeout (min) (ID=11602) | 122 |
| 7.10.2.4 | Event Timeout (s) (ID=11603) | 122 |
| 7.10.2.5 | Towing Make Call(Sms Event Number ID) (ID=11604) | 122 |
| 7.10.2.6 | Treshold (mg) (ID=11605) | 123 |
| 7.10.2.7 | Angle (deg) (ID=11606) | 123 |
| 7.10.2.8 | Duration (msec) (ID=11607) | 123 |
| 7.10.2.9 | Towing Send SMS (ID=7066) | 124 |
| 7.10.2.10 | SMS Text (ID=8066) | 124 |
| 7.10.3 | <i>Crash Detection</i> | 125 |
| 7.10.3.1 | Scenario settings (ID=11400) | 125 |
| 7.10.3.2 | Duration [ms] (ID=11401) | 125 |
| 7.10.3.3 | Treshold [mG] (ID=11402) | 125 |
| 7.10.3.4 | Crash trace (ID=11406) | 125 |
| 7.10.3.5 | Crash sms send to (ID= 7037) | 125 |
| 7.10.3.6 | SMS Text (ID=8037) | 126 |
| 7.10.4 | <i>Excessive idling</i> | 126 |
| 7.10.4.1 | Excessive idling priority (ID=11200) | 126 |
| 7.10.4.2 | Eventual records (ID=11203) | 126 |
| 7.10.4.3 | Excessive idling minimum stop duration (ID=11205) | 127 |
| 7.10.4.4 | Excessive idling minimum move duration (ID=11206) | 127 |
| 7.10.4.5 | Excessive idling output control (ID=11204) | 128 |
| 7.10.4.6 | Excessive idling output on duration (ID=11201) | 128 |
| 7.10.4.7 | Excessive idling output off duration (ID=11202) | 129 |
| 7.10.4.8 | Excessive idling Send SMS To (ID=7033) | 129 |
| 7.10.4.9 | Excessive idling SMS Text (ID=8033) | 130 |
| 7.11 | BLUETOOTH | 130 |
| 7.11.1.1 | BT Radio (ID=800) | 130 |
| 7.11.1.2 | Local name (ID 801) | 130 |
| 7.11.1.3 | Local PIN (ID=802) | 131 |
| 7.11.1.4 | Security mode (ID=803) | 131 |
| 7.11.1.5 | External MAC (ID=804) | 131 |
| 7.11.1.6 | External name (ID=805) | 132 |
| 7.11.1.7 | External PIN (ID=806) | 132 |
| 7.11.1.8 | Connection mode (ID=807) | 132 |
| 7.11.1.9 | Authorized devices MAC list (ID=830 - 834) | 133 |
| 7.12 | I/O PARAMETERS | 133 |
| 7.12.1 | <i>I/O#1 property parameter priority Ignition (ID=50000)</i> | 133 |
| 7.12.2 | <i>I/O#1 operand (ID=50001)</i> | 133 |
| 7.12.3 | <i>I/O#1 High level (ID=50002)</i> | 134 |
| 7.12.4 | <i>I/O#1 Low level (ID=50003)</i> | 134 |
| 7.12.5 | <i>I/O#1 Event only (ID=50004)</i> | 134 |
| 7.12.6 | <i>I/O#1 averaging length (ID=50005)</i> | 135 |
| 7.12.7 | <i>I/O#1 send SMS (ID=7000)</i> | 135 |
| 7.12.8 | <i>I/O#1 SMS text (ID=8000)</i> | 135 |
| 7.12.9 | <i>I/O elements parameters and types.</i> | 136 |
| 7.13 | OBD II (BLUETOOTH) | 140 |
| 7.13.1 | <i>1st OBD II (Bluetooth) property parameter priority (ID=40100)</i> | 140 |
| 7.13.2 | <i>1st OBD II (Bluetooth) property parameter operand (ID=40101)</i> | 141 |
| 7.13.3 | <i>1st OBD II (Bluetooth) property parameter High level (ID=40102)</i> | 141 |
| 7.13.4 | <i>1st OBD II (Bluetooth) property parameter Low level (ID=40103)</i> | 142 |
| 7.13.5 | <i>1st OBD II (Bluetooth) property parameter Event only (ID=40104)</i> | 142 |
| 7.13.6 | <i>1st OBD II (Bluetooth) property parameters Send SMS to (ID=7038)</i> | 142 |
| 7.13.7 | <i>1st OBD II (Bluetooth) property parameters SMS Text (ID=8038)</i> | 143 |
| 7.13.8 | <i>All OBD II (Bluetooth) I/O elements parameters property ID</i> | 143 |

| | | |
|-----------|--|------------|
| 8 | MOUNTING RECOMMENDATIONS..... | 144 |
| 8.1 | CONNECTING WIRES..... | 144 |
| 8.2 | CONNECTING POWER SOURCE..... | 144 |
| 8.3 | CONNECTING IGNITION WIRE..... | 145 |
| 8.4 | CONNECTING GROUND WIRE..... | 145 |
| 9 | FMB920 INSTALLATION INSTRUCTION | 146 |
| 10 | EC DECLARATION OF CONFORMITY..... | 147 |
| 11 | CHANGE LOG | 149 |

1 INTRODUCTION

1.1 Attention



Do not disassemble the device. If the device is damaged, the power supply cables are not isolated or the isolation is damaged, before unplugging the power supply, do not touch the device.



All wireless data transferring devices produce interference that may affect other devices which are placed nearby.



The device must be connected only by qualified personnel.



The device must be firmly fastened in the predefined location.



The programming must be performed using a second class PC (with autonomic power supply).



The device is susceptible to water and humidity.



Any installation and/or handling during a lightning storm are prohibited.

1.2 Instructions of safety

This chapter contains information on how to operate FMB920 safely. By following these requirements and recommendations, you will avoid dangerous situations. You must read these instructions carefully and follow them strictly before operating the device!

The device uses SELV limited power source. The nominal voltage is 12 V DC. The allowed range of voltage is 6 V...30 V DC.

To avoid mechanical damage, it is advised to transport the FMB920 device in an impact-proof package. Before usage, the device should be placed so that its LED indicators are visible, which show the status of operation the device is in.

When connecting the connection (1x5) cables to the vehicle, the appropriate jumpers of the power supply of the vehicle should be disconnected.

Before dismounting the device from the vehicle, the 1x5 connection must be disconnected.

The device is designed to be mounted in a zone of limited access, which is inaccessible for the operator. All related devices must meet the requirements of standard EN 60950-1.

The device FMB920 is not designed as a navigational device for boats.

1.3 Legal Notice

Copyright © 2016 Teltonika. All rights reserved. Reproduction, transfer, distribution or storage of part or all of the contents in this document in any form without the prior written permission of Teltonika is prohibited.

Other products and company names mentioned here may be trademarks or trade names of their respective owners.

The manufacturer reserves the right to make changes and/or improvements at any time in design, functionality, parameters and electrical characteristics without any prior notice and without incurring obligations.

1.4 About document

This document contains information about the architecture, possibilities, mechanical characteristics, and configuration of the FMB920 device.

Acronyms and terms used in document:

PC – Personal Computer;

GPS – Global Positioning System;

GPRS – General Packet Radio Service;

GNSS – Global Navigation Satellite System ;

GSM – Global System for Mobile Communications;

SMS – Short Message Service;

AC/DC – Alternating Current/Direct Current;

I/O – Input/Output;

Record – AVL data stored in FMB920 memory. AVL data contains GNSS and I/O information;

AVL packet - data packet which is being sent to the server during data transmission.

2 BASIC DESCRIPTION

FMB920 is tracking terminal with GNSS and GSM connectivity, which is able to collect device coordinates and transfer them via GSM network to server. This device is perfectly suitable for applications, which need location acquirement of remote objects.

Package contents¹

The FMB920 device is supplied to the customer in a cardboard box containing all the equipment that is necessary for operation. The package contains:

Already implemented FMB920 device into case;

Top and bottom device cover parts;

Input and output power supply cable with a 1x5 connection pins, which is already installed into device.

¹ Package content depends on Order Code, and can be customized by customer needs.

2.1 Basic characteristics

GSM / GPRS / GNSS features:

- Teltonika TM2500 quad band module (GSM 850 / 900 / 1800 / 1900 MHz);
- GPRS class 12;
- SMS (text, data).
- Integrated GNSS receiver
- Up to -162 dBm GNSS receiver sensitivity.

Hardware features:

- Built-in movement sensor;
- Built-in Bluetooth 3.0;
- Internal High Gain GNSS antenna;
- Internal High Gain GSM antenna;
- microSD card reader (up to 32Gb, FAT32);
- 170 mAh Li-ion rechargeable 3.7 V battery.

Interface features:

- Power supply: 10 ÷ 30V;
- 1 digital input;
- 1 analog input;
- 1 open collector digital output (connecting external relays, LED, buzzers etc.);
- 2 LEDs indicating device status.

Special features:

- Fast position fix;
- High Quality track even in high density urban canyon;
- Ultra small case;
- Ready for harsh environment;
- Color ribbon non-detachable cable;
- Easy to mount in limited access areas;
- Firmly fasten;
- High gain internal GNSS and GSM antennas;
- 2 LED status indication;
- Real-Time tracking;
- Smart data acquisition based on:
 - Time;
 - Angle;
 - Distance;
 - Ignition or any other I/O event;
- Sending acquired data via GPRS;
- GPRS and SMS I/O events;
- Virtual odometer;
- Jamming detection
- Configurable using Secured SMS Commands;
- Overvoltage protection.

Table 1 FMB920 Supply voltage

| Description | Voltage | Duration |
|---------------------------------------|---------|----------------|
| Normal operation | 10-30V | Unlimited |
| Protection turns on, device turns off | 34V | Unlimited |
| Maximum voltage | <70V | Unlimited |
| Maximum voltage impulse | 90V | 5 milliseconds |

2.2 Technical features

Table 1. FMB920 specifications

| Part name | Physical specification | Technical details |
|----------------|------------------------|---|
| Navigation LED | LED | <p>Power supply 10...30 V DC 2 W Max</p> <p>Energy consumption¹:</p> <p>GPRS: --- 63.48 mA r.m.s Max., Nominal: --- average 24.40 mA r.m.s, Nominal while charging: --- 120mA r.m.s.</p> <p>GPS Sleep: --- average 5.58 mA, Deep Sleep: --- average 4.06 mA² Online Sleep: --- average 4.62 mA Ultra Sleep: --- average 2.08 mA,</p> <p>Battery charge current: --- average 140 mA, Rated current: --- 250 mA,</p> <p>Operation temperature: -25 °C ... +55 °C</p> <p>Storage temperature: -40°C ... +70 °C</p> <p>Storage relative humidity 5 ... 95 % (no condensation)</p> <p>Internal fuse: 3A, 125V</p> <p>Weight: 54 g.</p> |
| Modem LED | LED | |
| Socket | Soldered inner socket | |
| USB | Micro USB socket | |

¹Energy consumption has been tested at 12V voltage with no battery charging.

²When in Deep Sleep mode no data storing and sending is activated.

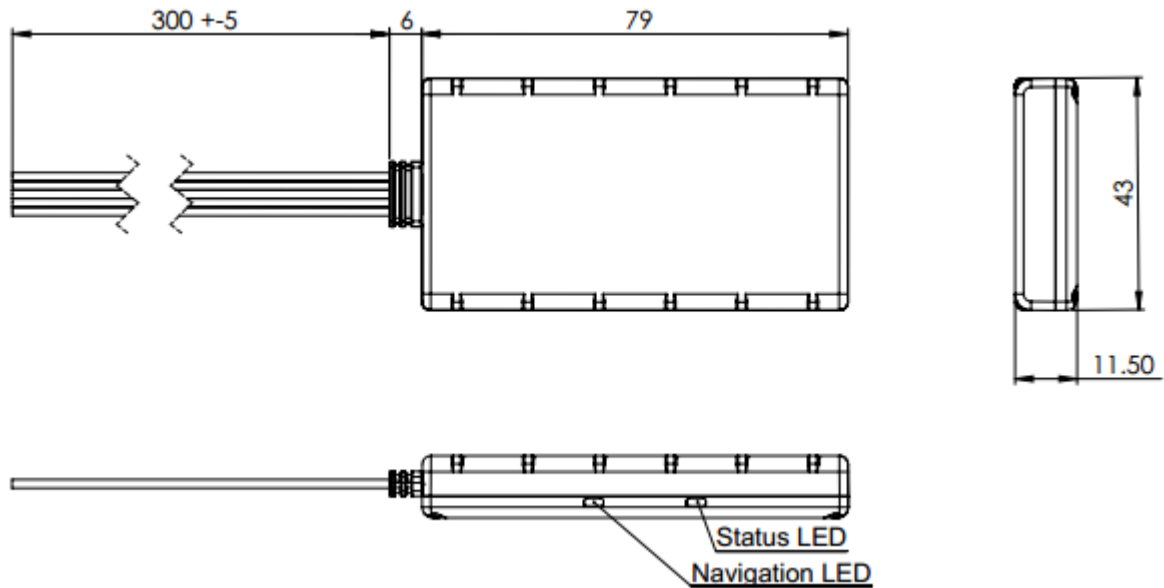

Figure 1 FMB920 view & dimensions (tolerance $\pm 2\text{mm}$)

2.3 Technical Information about internal battery

Table 2. Li-Polymer rechargeable battery, 3.7 V, 170 mAh..

| Internal back-up battery | Battery voltage V | Nominal capacity (mAh) | Power(Wh) | Charging temperature °C |
|---------------------------------|-------------------|------------------------|-----------|-------------------------|
| Li-Polymer rechargeable battery | 3.75~3.90 | ≥ 170 | 0.64 - 66 | 0 – 45 |

FMB920 internal battery is used for detecting external voltage disconnection.



CAUTION: RISK OF EXPLOSION IF BATTERY IS REPLACED BY AN INCORRECT TYPE. DISPOSE OF USED BATTERIES ACCORDING TO THE INSTRUCTIONS.

Battery Disposal instructions:



Battery should not be disposed of with general household waste. Bring damaged or worn-out batteries to your local recycling center or dispose them to battery recycle bin found in stores.

Warranty: batteries are covered by 6 month warranty support.

2.4 Electrical characteristics

| CHARACTERISTIC DESCRIPTION | VALUE | Min. | Typ. | Max. | Unit |
|---|-------|------|------|----------------|------|
| | | | | | |
| Supply Voltage: | | | | | |
| Supply Voltage (Recommended Operating Conditions) | 10 | | | 30 | V |
| Digital Output (Open Drain grade): | | | | | |
| Drain current (Digital Output OFF) | | | | 120 | μA |
| Drain current (Digital Output ON, Recommended Operating Conditions) | | | | 3,3 | mA |
| Static Drain-Source resistance (Digital Output ON) | | | | 300 | mΩ |
| Digital Input: | | | | | |
| Input resistance (DIN1) | 47 | | | | kΩ |
| Input Voltage (Recommended Operating Conditions) | 0 | | | Supply voltage | V |
| Input Voltage threshold (DIN1) | | | 2,5 | | V |
| Analog Input: | | | | | |
| Input Voltage (Recommended Operating Conditions) | 0 | | | 30 | V |
| Input resistance | | | 150 | | kΩ |
| Measurement error on 12V | | | 0,9 | | % |
| Additional error on 12 V | | | 108 | | mV |
| Measurement error on 30 V | | | 0,33 | | % |
| Additional error on 30 V | | | 88 | | mV |

2.5 Absolute Maximum Ratings

| CHARACTERISTIC DESCRIPTION | VALUE | Min. | Typ. | Max. | Unit |
|--|-------|------|------|------|------|
| | | | | | |
| Supply Voltage (Absolute Maximum Ratings) | -32 | | | 32 | V |
| Drain-Source clamp threshold voltage (Absolute Maximum Ratings), ($I_{\text{drain}} = 2\text{mA}$) | | | | 36 | V |
| Digital Input Voltage (Absolute Maximum Ratings) | -32 | | | 32 | V |
| Analog Input Voltage (Absolute Maximum Ratings) | -32 | | | 32 | V |

3 CONNECTION, PINOUT, ACCESSORIES

3.1 How to insert SIM card into FMB920 device:

① Remove FMB920 cover

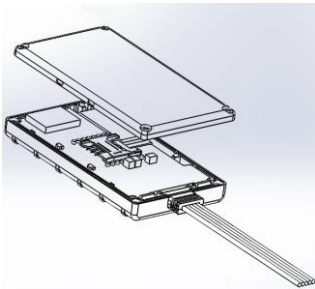

② Insert SIM card as shown

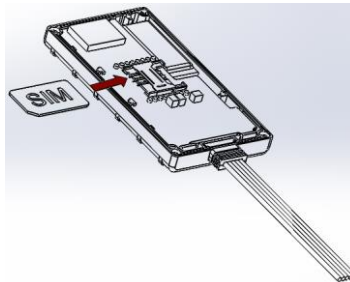

③ Attach cover

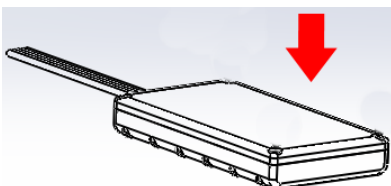

④ Device is ready

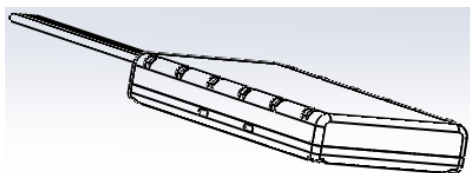

Note: SIM card insertion/removal must be performed when FMB device is powered off – external voltage and battery disconnected. Otherwise SIM card might be damaged or FMB device will not detect it.

3.2 How to add MicroSD card into FMB9XX device

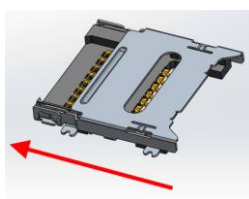

① Push MicroSD card lock case

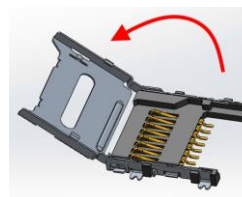

② Open MicroSD card locker

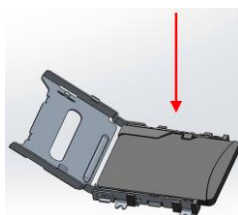

③ Correctly insert microSD card into slot

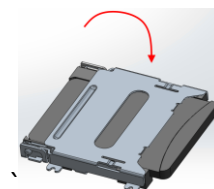

④ Close microSD card locker

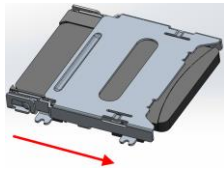

⑤ Push microSD card lock case to locked position

3.3 Installing FMB920 drivers

Table 3. Software requirements:

| Operating system (OS) | Version | MS .NET Framework version |
|---|-------------------|---|
| Windows XP with SP3 or later | 32 bit and 64 bit | MS .NET Framework 4 https://www.microsoft.com/en-US/Download/confirmation.aspx?id=17718 http://avl1.teltonika.lt/downloads/software/Framework/.NET%20Framework%204/dotNetFx40_Full_x86_x64.exe |
| | 32 bit 64 bit | With MS .NET Framework 4 update KB2468871-v2 update https://www.microsoft.com/en-us/download/details.aspx?id=3556 http://avl1.teltonika.lt/downloads/software/Framework/.NET%20Framework%204%20update%20KB2468871-v2/ NDP40-KB2468871-v2-x86.exe NDP40-KB2468871-v2-x64.exe or NDP40-KB2468871-v2-IA64.exe |
| Windows Vista Windows 7 Windows 8.1 Windows 10 | 32 bit and 64 bit | MS .NET Framework 4.6.2 https://www.microsoft.com/en-us/download/confirmation.aspx?id=53344 http://avl1.teltonika.lt/downloads/software/Framework/.NET%20Framework%204.6.2/NDP462-KB3151800-x86-x64-AIIO-ENU.exe |

Drivers:

Please download COM Port drivers from Teltonika website:
http://avl1.teltonika.lt/downloads/FMB9XY/MS_USB_ComPort_Driver_exe_v1.1032.3.zip

Installing drivers:

Extract and run FP_INBOX_InstallDriver_v1.1032.3.exe. This driver is used to detect FMB920 device connected to the computer. Click 'Next' in driver installation window (figures below):

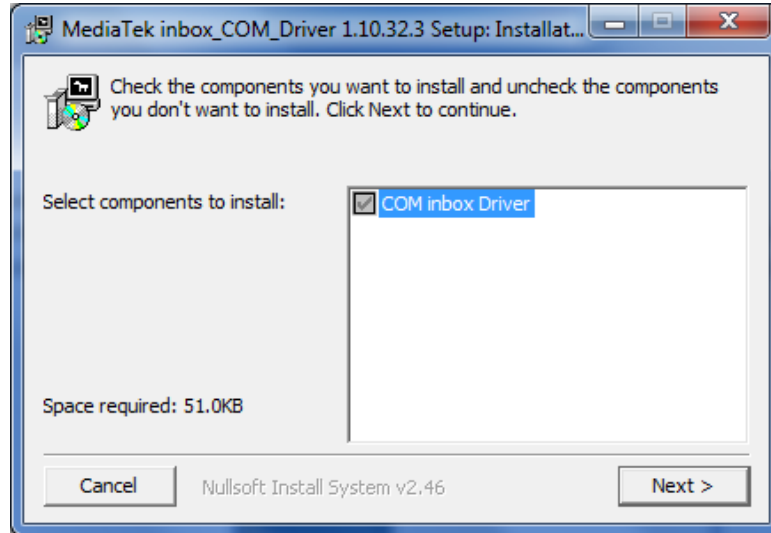

Figure 2 Driver installation window

This will launch device driver installation wizard. In the following window click 'Install' button:

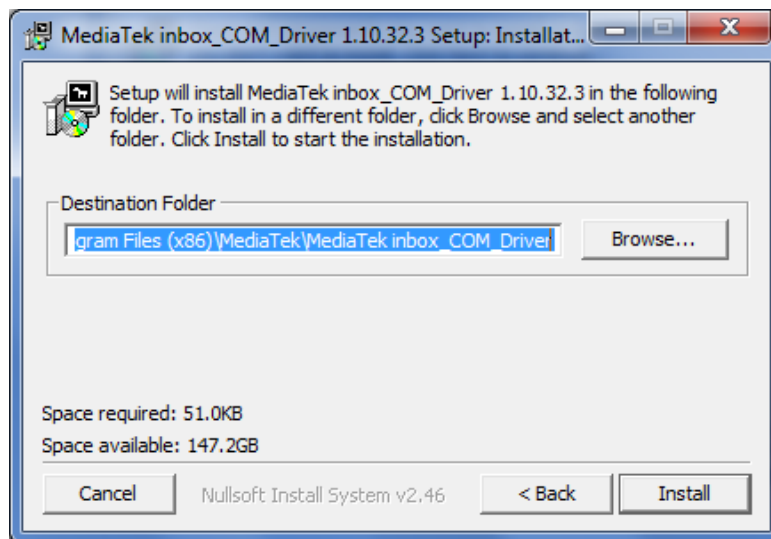

Figure 3 Driver installation window

Setup will continue installing drivers and will display a window about successful process at the end. Click 'Finish' to complete setup:

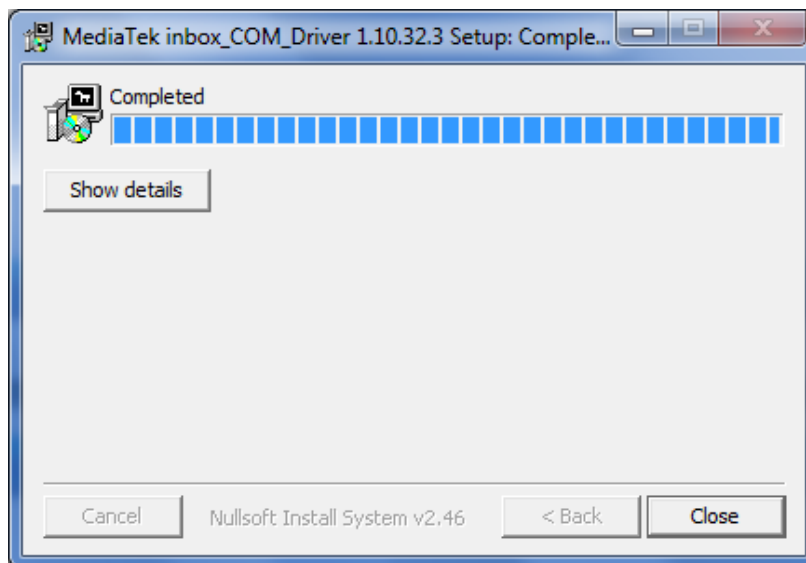

Figure 4 Driver installation window

You have now installed drivers for FMB920 device successfully.

Table 4 FMB920 pinout description

| Pin Nr. | Pin Name | Description |
|---------|------------------------|---|
| 1 | VCC (10÷30)V DC (+) | Power supply for module. Power supply range (10...30) V DC (+) |
| 2 | GND(VCC(10÷30)V DC)(-) | Ground pin. (10÷30)V DC (—) |
| 3 | DIN 1 | Digital input, channel 1. DEDICATED FOR IGNITION INPUT |
| 4 | AIN 1 | Analog input, channel 1. Input range: 0-30V DC |
| 5 | OUT 1 | Digital output, channel 1. Open collector output. Max. --- 3,3 A. |

3.4 Accessories



Note: Accessories are not included in device package, please order them separately.

Alarm buttons, door sensors, etc.

Alarm buttons, door sensors, ignition, etc. return two states: high or low voltage. Digital inputs are used to read this information. Figure below shows how to connect alarm button, door sensor, etc.

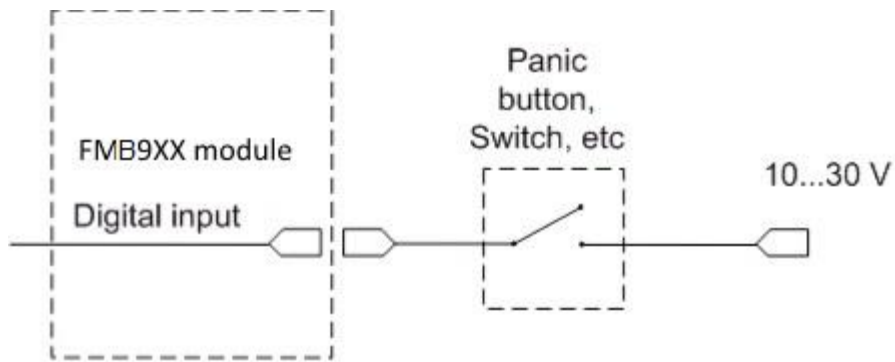

Figure 5 Panic button connection

In cases when sensor output signal is negative, an additional relay has to be installed to convert negative signal to positive.

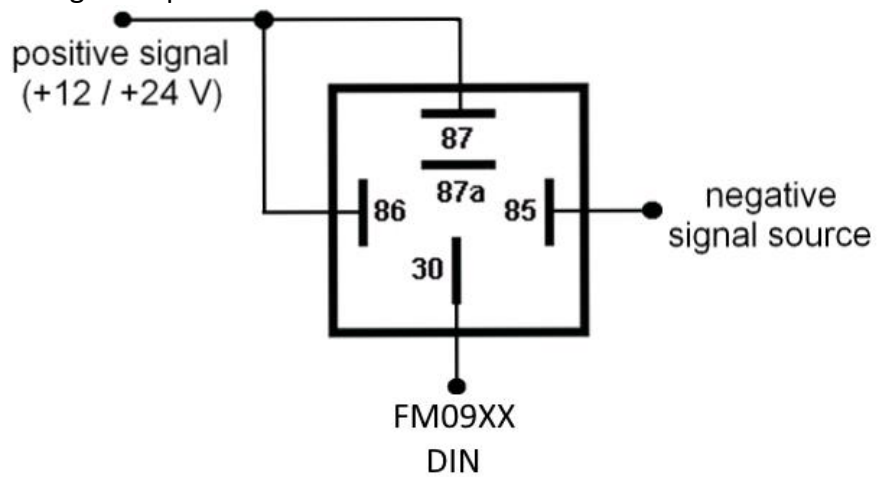

Figure 6 Inverting relay connection

Immobilizer relay

When connected as shown below, FMB920 disables engine starter when output is ON. More details about relays can be found below.

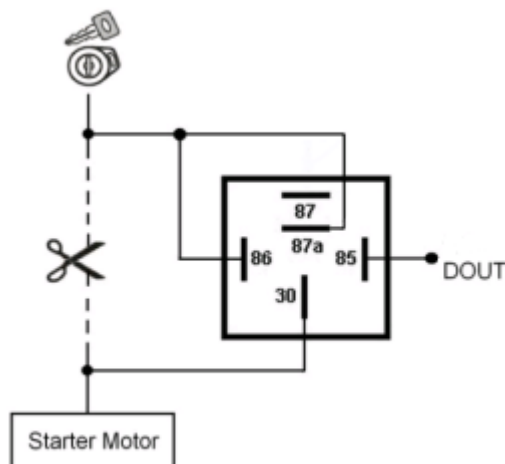

Figure 7 Immobilizer relay connection

Relays

An ordinary automotive relay is used to invert input signal or to immobilize engine starter. Note, that they are available as 12 V or 24 V.

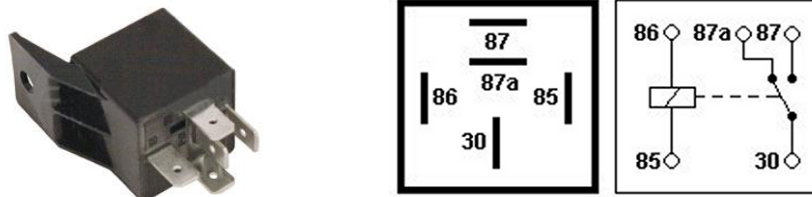

Figure 8 Automotive relay pinout

3.5 Terminal log for FMB devices

FMB device is able to transmit its current state when it is connected to PC using USB cable. It is used to detect errors and provide information for solution when device is operating as unexpected. Required Terminal application can be downloaded here:

<http://avl1.teltonika.lt/Downloads/Software/Terminal.zip>

After connecting FMB device to PC, it creates two ports:

- MTK USB Debug Port – used for modem trace;
- **MTK USB Modem Port** – used for Terminal log.

If connected FMB device is not recognized by PC, please install appropriate drivers. Here is download link:

<http://avl1.teltonika.lt/Downloads/FMB9XY/>

After selecting your port (usually lower number port) click connect and then click on 'Start Log' button. If log is not running, please send .log:1 command (see picture below).

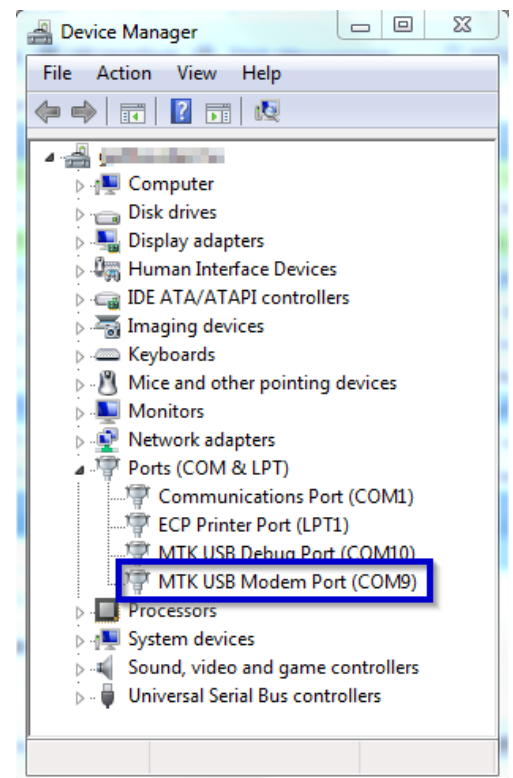

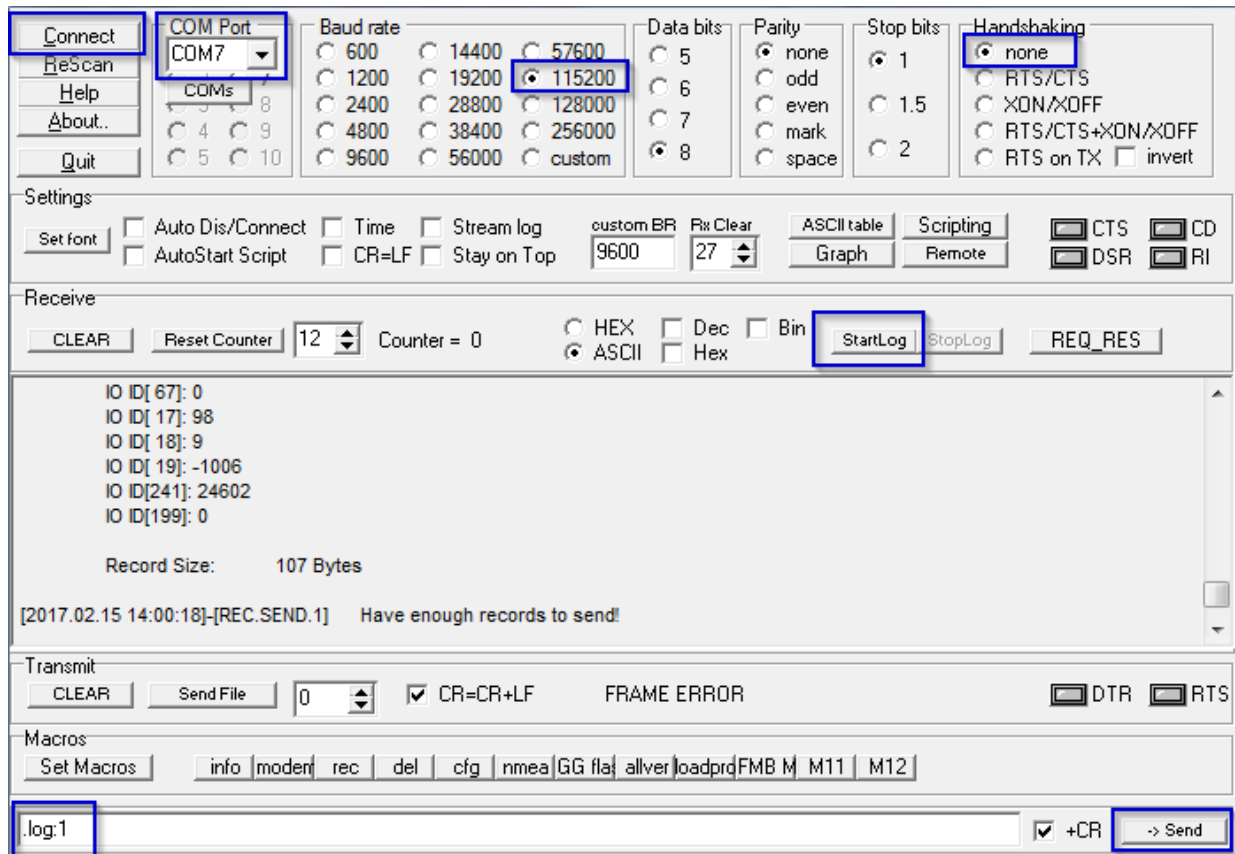

3.6 Navigate LED

| Behavior | Meaning |
|-------------------------|---|
| Permanently switched on | GNSS signal is not received |
| Blinking every second | Normal mode, GNSS is working |
| Off | GNSS is turned off because: <ul style="list-style-type: none"> • Deep sleep mode Or <ul style="list-style-type: none"> • GNSS antenna short circuited |

3.7 Status LED

| Behavior | Meaning |
|--------------------------------|--|
| Blinking every second | Normal mode |
| Blinking every 2 seconds | Deep sleep mode |
| Blinking fast for a short time | Modem activity |
| Blinking fast constantly | Boot mode |
| Off | <ul style="list-style-type: none"> • Device is not working Or <ul style="list-style-type: none"> • Device firmware being flashed |

4 OPERATIONAL BASICS

4.1 Operational principals

FMB920 module is designed to acquire records and send them to the server. Records contain GNSS data and I/O information. Module uses GNSS receiver to acquire GNSS data and is powered with three data acquiring methods: time-based, distance-based and angle-based. Note, that if FMB920 loses connection to GNSS satellites, it continues to make records, however coordinate in these records remains the same (last known coordinate). All data is stored in flash memory and later can be sent via GPRS.

GPRS and SMS settings are described in later sections. FMB920 communicates with server using special data protocol.

FMB920 can be managed by SMS commands. SMS Command list is described in

| | | |
|----|-----------|--|
| 26 | ICCID | Integrated Circuit Card Identifier |
| 27 | SD Status | 0 – SD card not inserted 1 – SD card inserted |
| 28 | Eco Score | Eco driving score during particular trip, 0 - 10 |

SMS COMMAND LIST section. Module configuration can be performed only via SMS.

4.2 Sleep modes

There are three sleep modes: GPS sleep, Deep sleep and Online sleep mode.

4.2.1 GPS Sleep mode

FMB920 is able to go to GPS sleep mode if such mode is enabled.

Sleep mode timeout (defined period in minutes) starts counting when device is in STOP mode. After timeout is reached and all conditions for GPS sleep mode are met, device goes to sleep mode. While in GPS sleep mode, FMB920 turns GPS module off and it is still making new periodic records. As a result power usage decreases, in turn saving vehicle battery.

FMB920 can enter GPS sleep mode if **ALL** of these conditions are met:

- FMB920 has to be configured to work in GPS Sleep mode and start sleep timeout is reached;
- Device must be synchronized time with GNSS satellites and have GPS fix;
- No movement by configured movement source or movement sensor is detected;
- Ignition (configured Ignition Source) is off.
- Forced wakeup is not set;
- Have no SMS to read;

FMB920 exits GPS sleep mode when if **ONE** of following conditions are true:

- Movement by movement source or movement sensor is detected;
- Ignition (configured Ignition Source) is turned on.

4.2.2 Deep Sleep mode

While in deep sleep mode, FMB920 sets GNSS receiver to sleep mode and turns off GSM/GPRS module (it is not possible to wake up device via SMS). Despite records with last known coordinate are being saved and send to AVL server (GSM/GPRS module is turned on to send data and after that it is turned off again), power usage is decreased to save vehicle's

battery. Note, that power saving depends on two configurable parameters: send period and min. record saving period in “X on Stop Mode”.

FMB920 can enter deep sleep mode if **ALL** of these conditions are met:

- FMBXX has to be configured in Deep Sleep Mode and Sleep timeout is reached
- Device must be synchronized time with GNSS satellites and have GPS fix;
- Ignition (configured Ignition Source) is off.
- Movement by accelerometer or configured movement source is not detected;
- Min. Record Saving Period (Data Acquisition Mode settings) must be bigger than Active Data Link Timeout parameter, that FMB920 could close GPRS link.
- Send period (Data Acquisition Mode settings) minus Active Data Link Timeout must be more than 90 sec., that FMB920 could close GPRS link for at least 90 sec.
- Forced wakeup is not set;
- Have no SMS to read;
- Data socket(s) are close;
- Data sending is not in progress;
- FOTA is not in progress;

FMB920 exits deep sleep mode when if **ONE** of following conditions are true:

- Movement by accelerometer or configured movement source is detected;
- Ignition (configured Ignition Source) is turned on.

4.2.3 Online Deep Sleep mode

In this mode device works as in Deep Sleep mode, but without deregistering from GSM network. GSM part stays powered, so this increases power consumption. In this mode, device should receive/send SMS and make/receive calls. Also not closes GPRS context, if previously opened.

Conditions to enter Online Sleep mode is the same as entering Deep Sleep mode.

FMB920 exits Online Sleep mode when if **ONE** of following conditions are true:

- Movement by accelerometer or configured movement source is detected;
- Ignition (configured Ignition Source) is turned on.

4.3 Virtual odometer

Virtual odometer is used to calculate traveled distance in FMB920 as separate I/O elements. When FMB920 detects movement, it starts counting distance using GNSS signal: every second it checks current location and calculates distance between current and previous point. It keeps adding these intervals until it is time to make a record, then FMB920 records its location and adds odometer value, which is equal to the sum of all distances, measured every second. There are two odometers I/O elements: Total odometer and Trip odometer.

Total odometer counts all distance traveled by vehicle. After device restart the value in this I/O element will not be erased. Total odometer value can be changed by SMS command “odomet” (SMS Command list is described in

| | | |
|----|-------|------------------------------------|
| 26 | ICCID | Integrated Circuit Card Identifier |
|----|-------|------------------------------------|

| | | |
|----|-----------|--|
| 27 | SD Status | 0 – SD card not inserted 1 – SD card inserted |
| 28 | Eco Score | Eco driving score during particular trip, 0 - 10 |

SMS COMMAND LIST section).

Trip odometer is Trip scenario element and it can be selected from two modes: Continuous and Between Records. Both modes requires ignition (configured ignition source) to be turned on.

When Between Records mode is selected, when record is made, odometer resets to zero and distance calculation starts all over again.

When Continuous odometer mode is selected, all distance calculations is counted from records and sums them to one distance. Continuous odometer stops counting, when vehicle is at stop and ignition is turned off.

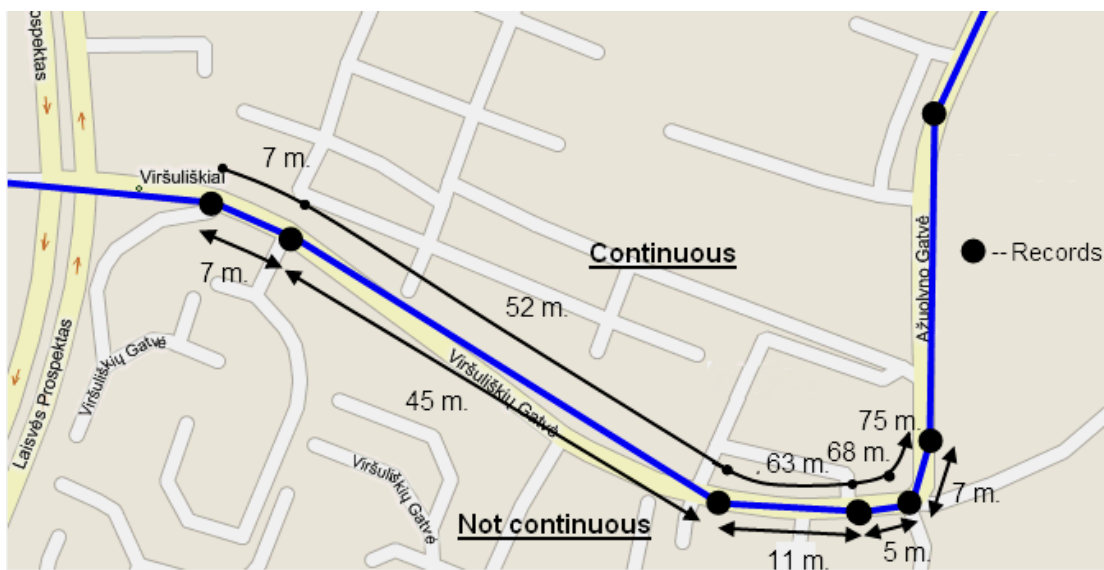

Figure 9 Odometer continuous and Not continuous distance counting parameter example

4.4 Features

Using available features can greatly increase FMB920 usability options.

4.4.1 ECO driving/Green driving Scenarios

Four scenarios are available on FMB920 device.

Digital Output is used by scenarios – ECO driving/Green driving **and/or** Over Speeding;



ECO driving/Green driving Scenarios. Helps to prevent and inspect driver about harsh driving. Eco driving scenario continuously monitors: accelerating, braking and cornering forces depending on build in accelerometer or Green driving depending on GPS. The device inspects driver if needed. Monitoring sensitivity is configurable.

DOUT1 is controlled by scenario for user needs, buzzer or LED for example. Output activation time after harsh event is also configurable.

To save GPRS traffic ECO driving/Green driving event will be **generated (included into records) only** when FMB920 measured values are higher than those set in configuration, without additional I/O settings.

To prevent generating false events, harsh acceleration and harsh braking is monitored only when following conditions are fulfilled:

- Ignition is ON (configured Ignition Source)
- Vehicle speed is equal or higher than 10km/h

Harsh cornering is monitored only when following conditions are fulfilled:

- Ignition is ON (configured Ignition Source)
- Vehicle speed is equal or higher than 30km/h

ECO driving or Green driving Scenario? Eco driving is based on accelerometer value and Green driving based on GPS position.



PLEASE NOTE that Eco Driving functionality generally is dependent on accelerometer. Device must be on plain/horizontal surface to calibrate itself correctly. It calibrates once it is powered up.

4.4.2 Over Speeding Scenario.

Helps to prevent from exceeding fixed speed and inspects driver if needed. DOUT1 is controlled by scenario for user needs, to manage buzzer, LED, etc.

4.4.3 Jamming detection

Jamming detection shows when GSM signal jamming occurs. DOUT1 is controlled by scenario for user needs, to manage buzzer, LED, etc.

4.4.4 Trip

Trip customizable feature enables user extended monitoring of performed trips (from engine start at present location to engine stop at arrived location), log their start and stop points, view driven total distance³ and calculate eco score value.



Note: Scenarios and Trip feature are activated (DOUTs are activated) only if ignition is on.

³ Continuous odometer – total driven distance, works only in TRIP mode. Continues distance is counted only for ONE trip. If trip is finished (stop point is detected), odometer resets to 0 (zero). Next trip will start counting from the beginning.

4.4.5 DOUT Control Via Call

Activates DOUT on incoming call



Note: in Excessive Idling, Jamming and Trip scenarios if Eventual Records is enabled Event will be **generated (included into send records) only** when scenario starts and finishes. If Eventual Records is disabled scenario status value is sent in each AVL record.

4.5 GPS Fuel Consumption

This functionality is meant to calculate fuel consumption based on set consumption values in different situations.

4.6 Scenarios Accelerometer

4.6.1 Excessive Idling

Informs you if your vehicle is stationary but engine is on for selected period of time to help you to save fuel.

4.6.2 Unplug Detection

Unplug detection scenario generates event when FMB920 is unplugged from external power and plugged into external power.

4.6.3 Towing Detection

Towing detection feature helps to inform driver about car departing. FM962 generates event when car is being towed or lifted, for example in case of vehicle evacuation.

4.6.4 Crash Detection

If Crash detection is enabled, it monitors acceleration on each axis, which helps to detect an accident.

If Crash trace is disabled crash detection event will be generated (included into send record) only when scenario starts and finishes.

If Crash trace is enabled FMB920 will collect acceleration data every 40 msec. Buffer is big enough to hold data for 5 seconds and on Crash Event detection, records will be generated from this buffer, following these conditions:

- Every second Acceleration changed more then > 50mG Data will be collected and records generated 5 seconds after the event using the same conditions.
- Every generated record will have accelerometer X Y Z values included.
- Each record will have accurate timestamps in milliseconds.



Note: in Unplug Detection and Towing Detection scenarios if Eventual Records is enabled Event will be **generated (included into send records) only** when scenario starts and finishes. If Eventual Records is disabled scenario status value is sent in each AVL record.

4.7 Bluetooth

Bluetooth can work in two modes - *slave* or *master*.

While working as *master* mode - Bluetooth can connect to defined "*hand free*" or "*OBDII*" system.

While working as *slave* mode - Bluetooth can accept incoming connection from external device.

FMBXX supports one connection at a time.

NOTE: FMB920 can see up to 10 available devices. If there are more than 10, with each scanning the list may change.

5 CONFIGURATION

5.1 Configurator

New FMB920 module has default factory settings. Settings should be changed according to your application and your GSM operator information.

FMB920 configuration may be performed via SMS commands or configurator.

FMB920 has one user editable profile.

It can be configured to acquire and send data to server. If device is not able to send data to server, GSM is not available FMB920 will start storing records to flash memory. It is possible to store up to 122880 data records with 64mb SD memory card. It will send data later when GPRS is available again. Note that FMB920 can have memory full of records. In such case it will start deleting oldest records in order to save new ones. Sending all data records to server may take some time.

FMB920 configuration is performed via FMB920 Configurator program. Contact sales manager to get the latest FMB920 Configurator version. FMB920 configurator operates on Microsoft Windows OS and uses MS .NET Framework. For Windows XP you will need MS .NET Framework 4 (with MS .NET Framework 4 update KB2468871-v2) for Windows Vista, Windows 7, Windows 8.1, Windows 10 MS .NET Framework 4.6.2 or later. Please ensure that suitable MS .NET Framework version for your OS is installed on your PC before starting configurator. Latest MS .Net Framework version can be downloaded from official Microsoft web page.

Module configuration is performed over USB cable. Configuration process starts from starting FMB920 Configurator program and then connecting to FMB920 device via Connect button located in Online menu part. FMB920 has one user editable profile, which can be loaded from device, and saved. User can also revert to default settings, by pressing Reset to defaults button. After any modification of configuration settings it has to be saved to FMB920 device, otherwise it will not be written to device.

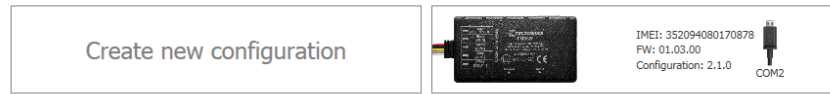

Figure 10 FMB920 configurator window when selecting the connection method

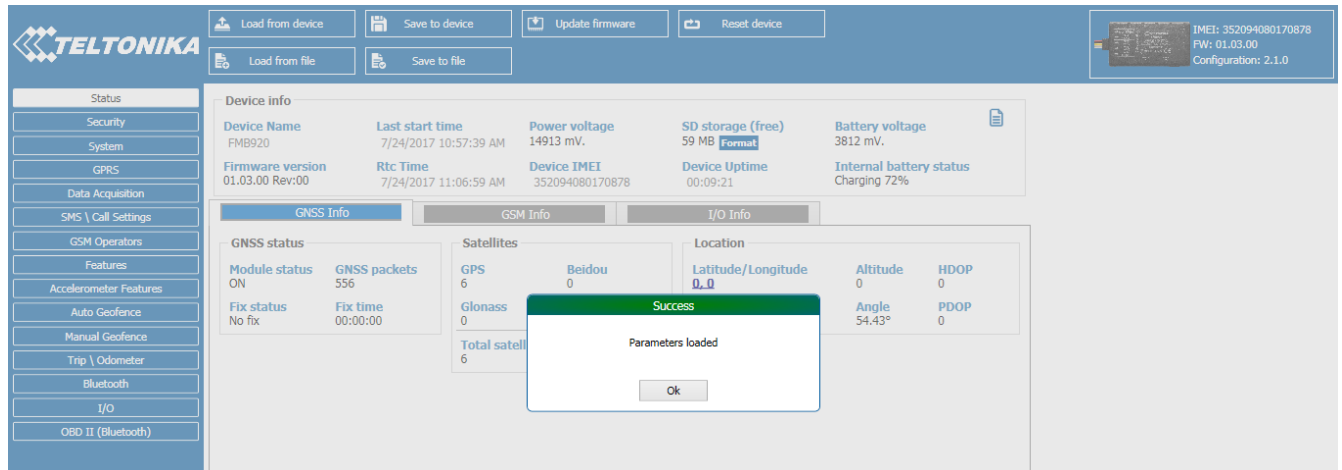

Figure 11 FMB920 configurator main window when connected to it and successfully loaded parameters

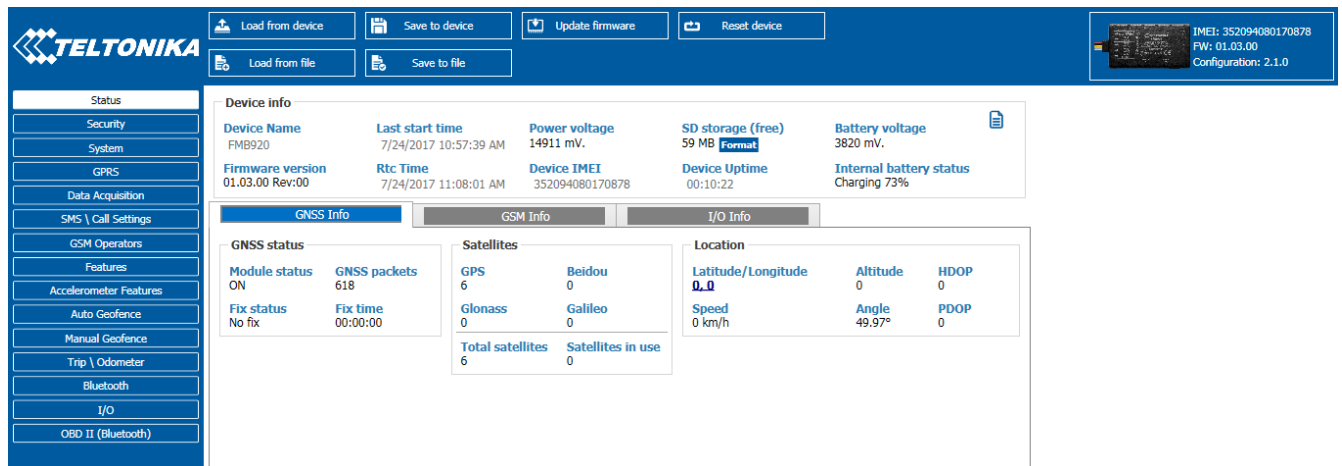

Figure 12 FMB920 configurator status column

5.1.1 Main Buttons description:

- 'Connect to device' (Figure 10) – connects device.
- 'Load from device' – loads configuration from device.
- 'Save to device' – save configuration to device.
- 'Load from file' – load configuration from file.
- 'Save to file' – save configuration to file.
- 'Update firmware' – update firmware on device.
- 'Reset device' – reset device configuration to default.

5.1.2 Keyword SMS (GPRS) commands:

"setkey <oldkeyword> <newkeyword>" - Set new or change the keyword. Configuration should be not locked. Example:

New keyword (set):

```
<name>{space}<pass>{space}setkey{space}{space}<newkeyword>
```

Change keyword (change):

```
<name>{space}<pass>{space}setkey{space}<oldkeyword>{space}<newkeyword>
```

"delkey <keyword>" - Deletes current keyword. Configuration keyword should be configured and not locked.

Example:

```
<name>{space}<pass>{space}delkey{space}<keyword>
```

5.1.3 Keyword configuration with TCP

If configuration has keyword, it will be saved to configuration file.

After TCP configuration: if keyword in configuration file does not match keyword in device, configurator will ask which keyword must be used for device.

If device is locked, keyword cannot be changed with TCP configuration.

5.2 Status info

Status info monitoring FMB920 real time information in 5 different positions: Device info, GNSS info, GSM info, OBD info and I/O info. All this information can be saved into .HTML format with a button which is in device info table top right corner.

In device info user can see device name, firmware version, last device start time, RTC Time, power voltage (mV), device IMEI, SD card free space, Device uptime, Battery voltage (mV) and internal battery status.

In GNSS info user can see:

- Real time GNSS status information: module status (ON, deep/GPS/Online sleep mode), how much GNSS packets device got from startup, what is fix status and what was last GNSS fix time.
- Satellites information: how many and what type of satellites are visible. How many satellites are used for location positioning.
- Location information: latitude, longitude, altitude, angle, HDOP, PDOP and speed.

In GSM Info user can see:

- GSM status: modem status, SIM status, GPRS status, actual operator code and GSM signal level.
- GPRS traffic: how much data has been send from device and received from device.
- Sockets information: what server domain and port is used.
- Records: how much records were send to server from last data reset, when last record send to server was and when was last server response.
- SMS count: how much FMB920 received SMS and how much SMS was send from device.

In OBD info user can see (if device connected to car with OBD II Bluetooth dongle adapter) car's VIN code and used OBD protocol.

In I/O info user can see all I/O element values from all configurable I/O elements.

5.3 Security info

In security section user can see SIM card and configurator keyword security information.

- User can see SIM state and SIM current status. If used SIM card with PIN code user can enter it here. How much attempts left to enter pin code is showed to.
- For configuration security keyword can be set to configurator. Keyword can be saved in configuration file (.cfg), so there is no need to connect the device to the configurator to configure keyword. Min keyword length is 4 symbols and max length is 10 symbols. Only uppercase and lowercase letters and numbers are supported. Keyword can be configured to .config configuration file when device is not connected to device.

5.4 System settings

System settings have 9 configurable parameters:

- Sleep settings, where user can choose sleep mode;
- Ignition source, where user can choose between power voltage, digital input 1, accelerometer and engine RPM as ignition sources. More than one ignition source can be selected at the same moment. User can select movement start and movement stop delay time (in seconds): those parameters are used when ignition source is accelerometer. Into ignition status take the following functionalities: power manager, eco driving, excessive idling, fuel consumption, over speeding, towing and trip functionalities.
- Object Motion Detection Settings, where user can configure 4 ways how FMB920 will detect stopped movement, and change its working mode (for working modes, read section 5.10). Other functionalities that depend from movement source: power manager, fuel consumption and trip.
- Static navigation settings, where user can turn static navigation on or off. Additional, user can chose from what source (movement or ignition) static navigation can be deactivated/activated;
- Records Settings, where user can enable or disable records when GPS is not available (no time synchronization);
- GNSS source Settings, where user can choose satellite system.
- LED indication, where user can turn on or off indication leds.
- Battery charge mode, where user can choose when battery will be charged: on need (battery will be charged anytime when it need to be charged) and after ignition ON (battery will be charged only when ignition is on).
- Time synchronization settings, where user can choose from what source (or sources) FMB920 time will be synchronized. User has choice to use only one synchronization source by GNSS. When selected synchronization from NTP, time will be synchronized from NTP server and from GNSS. When selected synchronization from NITZ, time will be synchronized from GSM operator and GNSS. When selected synchronization from NITZ+NTP, time will be synchronized from all three sources (if it is necessary). Every time GNSS fix will be acquired time will be synchronizes (if needed). User can select from what NTP server (possible to configure two servers) time will be synchronized and what time period (in hours) is used to resynchronize time.

Table 5 Configuration parameters

| Movement Source | Vehicle on Stop mode | Vehicle Moving mode |
|----------------------------|---|--|
| Ignition (recommended) | If ignition (ignition source) is logic low | If ignition (ignition source) is logic high |
| Movement (movement sensor) | Internal movement sensor does not detect movement | Internal movement sensor detects movement |
| GPS | GPS fix is available and vehicle speed is lower than 5 km/h | GPS fix is available and vehicle speed is higher than 5 km/h |
| | While GPS fix is unavailable, Object Motion Detection Settings are working like in Msensor mode | |
| CAN speed | If speed from BT OBDII dongle is equal 0 km/h | If speed from BT OBDII dongle is higher than 0 km/h |

Static Navigation Mode is a filter, which filters out track jumps when the object is stationary. If Static navigation filter is disabled, it will apply no changes on GPS data. If Static navigation filter is enabled, it will filter changes in GPS position if no movement (configured movement source) or ignition (configured ignition source) is detected (depends on what static navigation settings is selected: movement, ignition or both sources). It allows filtering GPS jumps when object is parked (is not moving) and GPS position is still traced.

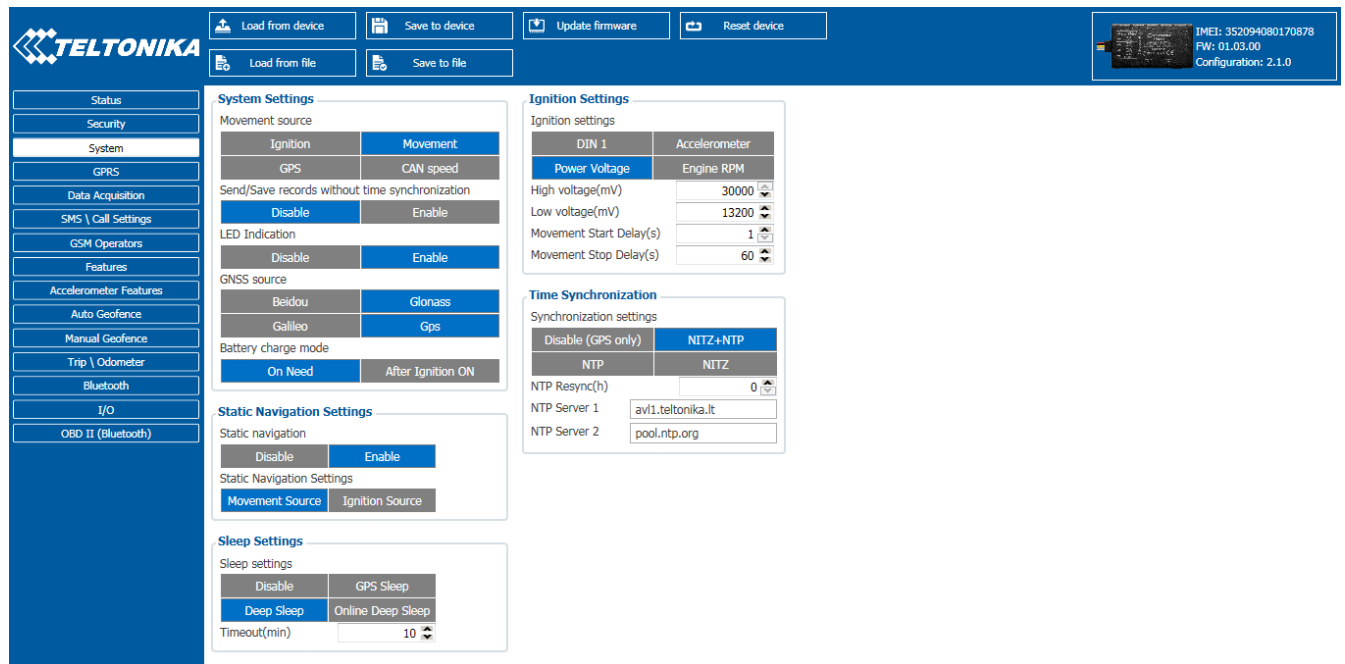

Figure 13 System settings configuration

In GNSS source Settings user can configure which GNSS system or systems to use.

User has choice to use only one system of GPS, Glonass, Galileo or Beidou. Also it is able to chose two or three systems together. One exception is that you can not combine Beidou and Glonass systems together.

List of configurable GNSS sources:

Beidou only
Glonass only

ID:01
ID:02

GNSS source

| | |
|---------|---------|
| Beidou | Glonass |
| Galileo | Gps |

| | |
|---------------------|-------|
| Galileo only | ID:04 |
| Galileo+Beidou | ID:05 |
| Galileo+Glonass | ID:06 |
| GPS only | ID:08 |
| GPS+Beidou | ID:09 |
| GPS+Glonass | ID:10 |
| GPS+Galileo | ID:12 |
| GPS+Galileo+Beidou | ID:13 |
| GPS+Galileo+Glonass | ID:14 |

Example of good configuration

List of **NON**-configurable GNSS sources:

- Glonass+Beidou
- Galileo+Glonass+Beidou
- GPS+Glonass+Beidou
- GPS+Galileo+Glonass+Beidou

GNSS source

| | |
|---------|---------|
| Beidou | Glonass |
| Galileo | Gps |

Example of bad configuration

5.5 Records settings

Here user can modify if FMB920 device will send newest records first, meaning, that the most important thing is to know recent position of car, older records are being sent right after newest records arrive to AVL application.

Activate Data Link Timeout is used to set timeout of link between FMB920 and AVL application termination. If FMB920 has already sent all records it waits for new records before closing link. If new records are generated in the period of this timeout, and minimum count to send is reached, they are sent to AVL application. This option is useful when GSM operator charge for link activation.

Server Response Timeout is used to set time period waiting for response from server side.

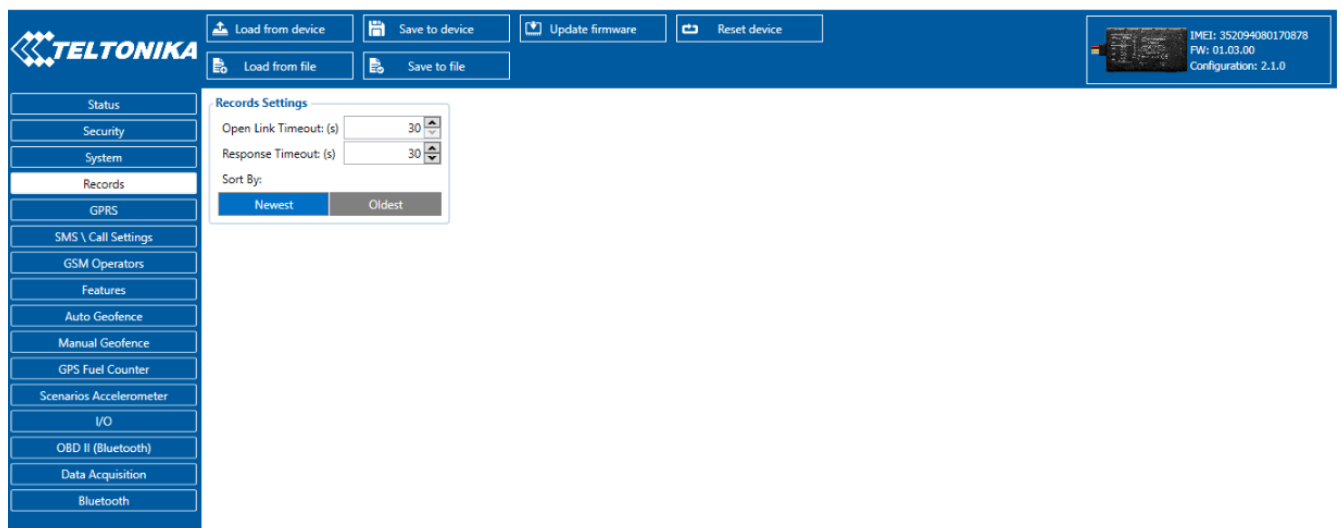

Figure 14 Records settings configuration

5.6 GSM settings, GPRS part

'GPRS' defines main parameters for FMB920: GSM operator APN and GPRS username and password (optional – depending on operator), destination server IP and port, and allows to set

protocol used for data transfers – TCP or UDP. Also all server setting and backup server mode can be selected for backup server configuration.

Backup server has 3 different modes:

- Disable: backup server is not used.
- Backup: send to backup server if main server not available (Failed to open Link) or, main server response timeout is detected 5 times in row.
- Duplicate: send records to both servers (main and backup), delete record from sd card (or RAMS) only if both servers accepted records.

5.7 GPRS Authentication

How configurable parameters: GPRS Authentication. Parameter possible values: 0 – Normal (PAP) and 1 – Secured (CHAP).

These are the Password Authentication Protocol (PAP), and the Challenge Handshake Authentication Protocol (CHAP). When a connection is established, each end can request the other to authenticate itself, regardless of whether it is the client or the server.

PAP - The client authenticates itself by sending a user name and an (optionally encrypted) password to the server, which the server compares to its secrets database.

CHAP - The client uses the hostname to look up the appropriate secret, combines it with the challenge, and encrypts the string using a one-way hashing function.



NOTE: This functionality is implemented from firmware: FMB.Ver.03.06.01.Rev.00, configurator: FMB.Configurator_v0.10.25

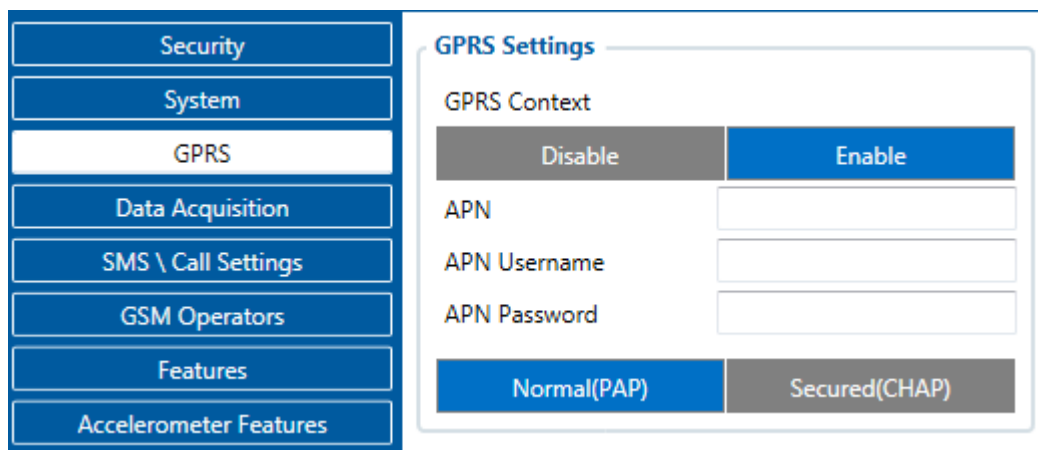

Figure 15 GPRS configuration

5.8 GSM settings, SMS/Call part

Essential fields in ‘SMS’ part is ‘Login’ and ‘Password’. The login and password are used with every SMS sent to FMB920. If login and password are not set, in every SMS sent to FMB920 device two spaces before command have to be used (<space><space><command>).

Command structure with set login and password:

<login><space><password><space><command>, example: “asd 123 getgps”

Phone numbers have to be written in international standard, with using “+” or without using it (in both cases number will be recognized, but when number is without “+” symbol, it will not generate IDD Prefix, which depends on location of phone). If no numbers are entered, configuration and sending commands over SMS are allowed from all GSM numbers.

SMS data sending settings allows or does not allow sending AVL data using binary SMS. AVL data will be send by SMS only when there are no GPRS connection. This setting does not affect replies to SMS request messages – answers are always sent back to sender telephone number.

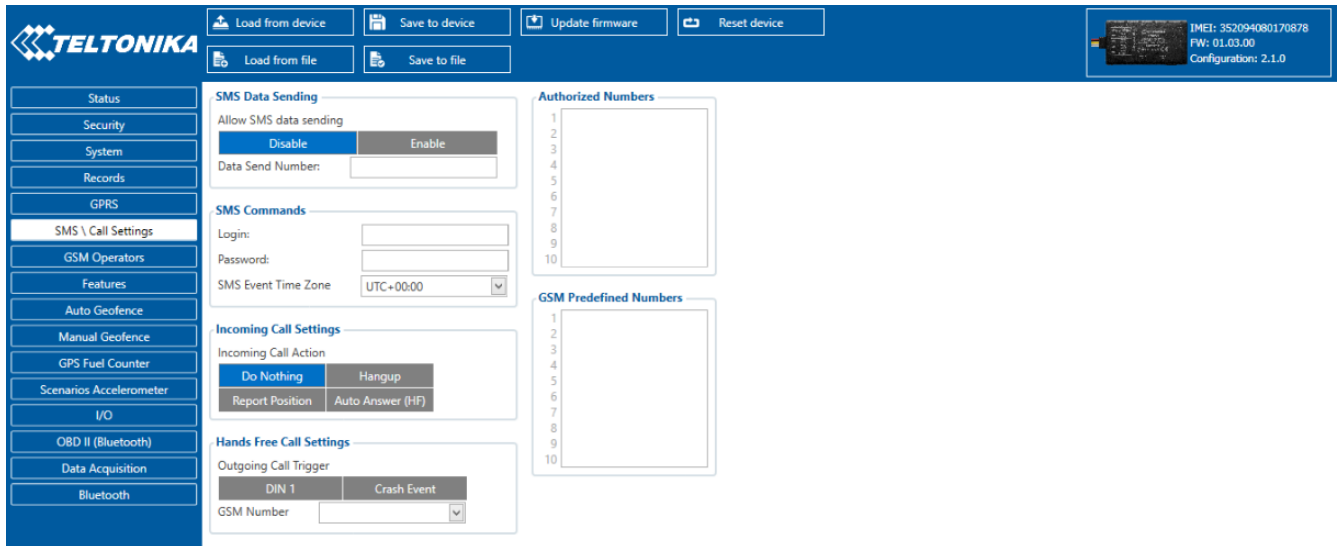

Figure 16 SMS \ call Settings configuration

Incoming Call Settings

This parameter defines device action during incoming call:

- Do Nothing
- Hang up – automatically hang up incoming call
- Report Position – Report position to calling number via SMS
- Auto Answer (HF) – Auto answer incoming call if hands free device is connected.

Hands free call functionality

When FMBXX is connected to hands free headset it can call to user defined GSM numbers.

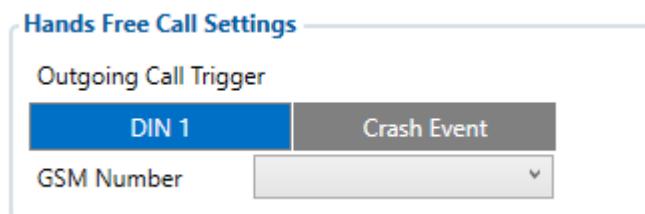

Figure 17 Hands Free Call Settings configuration

Outgoing Call Trigger parameter determines which event will triggers call. FMBXX supports four different call triggers:

- None selected – disables call trigger functionality.
- DIN1 – first digital input event triggers call to user selected GSM number.

- Crash Event – crash event triggers call to user selected GSM number.
- DIN1 and Crash Event – both events triggers call to user selected GSM number.

SMS Event Time Zones

FMB9XX works with synchronized GPS time which is UTC+0, with this option customer can configure his time zone and get SMS with correct time.



Note: Please do not set Data Send Number to some cell phone number, because it will not understand binary SMS. When sending a binary SMS to a phone number, which is a server phone number, the server can interpret and understand binary code, so the data can be read and you can view it on the server.



SMS login and password and authorized number list are used to protect FMB920 module from unauthorized access. Module accepts messages only from a list of authorized numbers and with proper module login and password. Phone numbers have to be written in international standard, with using “+” or without using it (in both cases number will be recognized). If no authorized numbers are entered, module accepts messages from all numbers.

5.9 GSM Operators, Roaming Operator list, Blacklist Operator list

Operators list – FMB920 can work in different modes (use different settings) according to the operator list defined. Operator list is used for Data Acquisition Mode switching (see chapter 5.10 Data Acquisition Mode settings for more details). Modes are changed based on GSM operator FMB920 is connected to.

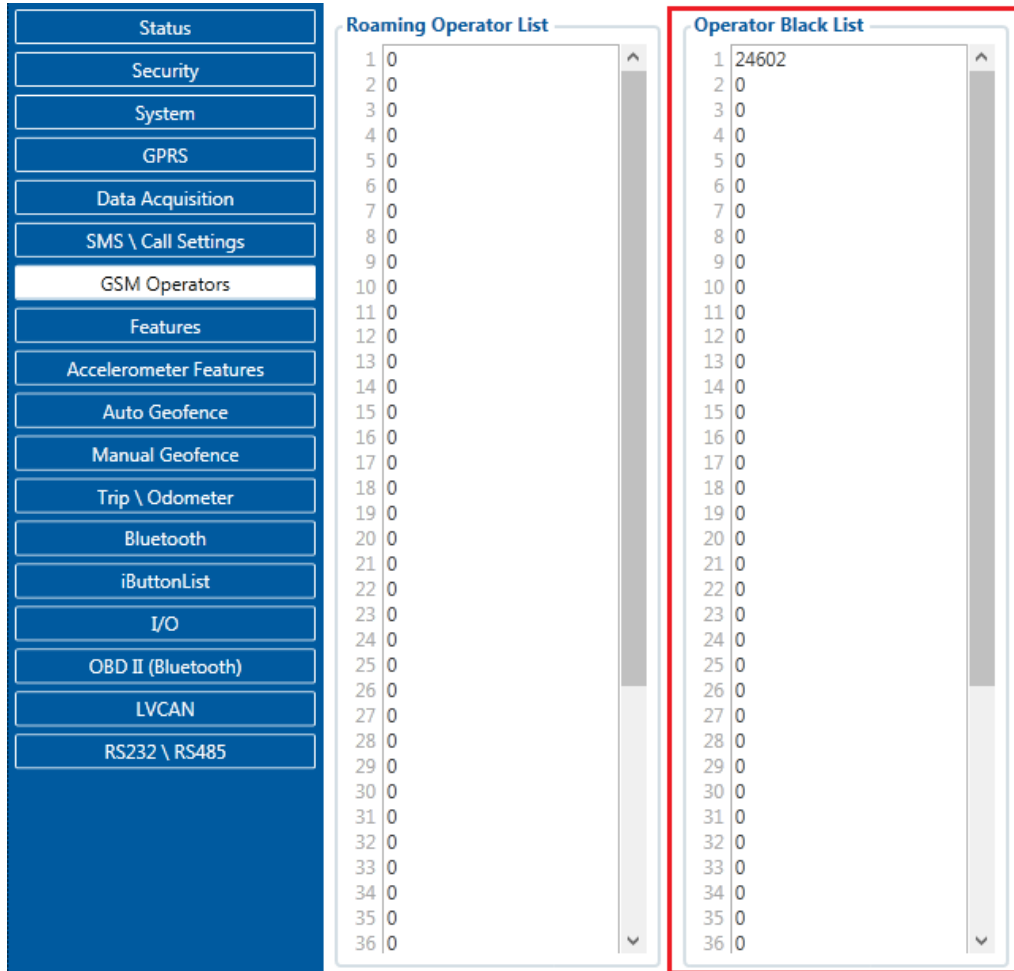

Figure 18 Roaming Operator list configuration

If roaming operator list is left empty, FMB920 will automatically detect home operator. If home operator will be written to roaming operator list any part, it will be detected as home operator, not roaming. Any not written operator in roaming operator list (not home operator) will be recognized as unknown operator and FMB920 will work in **Unknown mode** (make sure it is configured to allow data sending – GPRS context is enabled).

Operator Blacklist - if user wants that FMB920 do not connect and work with a particular operator it must be written to Operator BlackList. Total 50 operators can be written to this list.

Operator Blacklist working: Operator search procedure is initiated as normal every 15 minutes. If device connects to operator from black list – best operator search procedure is initiated instantly. Depending on White list device finds new operator to connect to. If no operator was found in configured White list – device tries to connect to operator with strongest signal, except if it's in Black list, then second best operator connection would be initiated and so on. During the time when device is connected to Black list operator - no GPRS connection would be initiated and no data would be send via GPRS.

5.10 Data Acquisition Mode settings

Data Acquisition Modes are an essential part of FMB920 device, it is also highly configurable.

By configuration user defines how records will be saved and sent. There are three different modes: Home, Roaming and Unknown. All these modes with configured data acquisition and

send frequencies depend on current GSM Operator defined in Roaming Operator list (see section 5.9) and are switched when GSM operator changes (e.g. vehicle passes through country boarder).

If current GSM operator is defined as Home Operator, device will work in Home Data Acquisition mode, if current operator is defined as Roaming Operator, device will work in Roaming Data Acquisition mode, and if current operator code is not written in Roaming Operator list, device will work in Unknown Acquisition mode.

This functionality allows having different AVL records acquire and send parameters values when object is moving or stands still. Vehicle moving or stop state is defined by Stop Detection Source parameter. There are 3 ways for FMB920 to switch between Vehicle on Stop and Vehicle Moving modes see section 5.4.

FMB920 has 6 different modes. Operational logic is shown in Figure 19.



If home operator will be written to roaming operator list any part, it will be detected as home operator, not roaming.

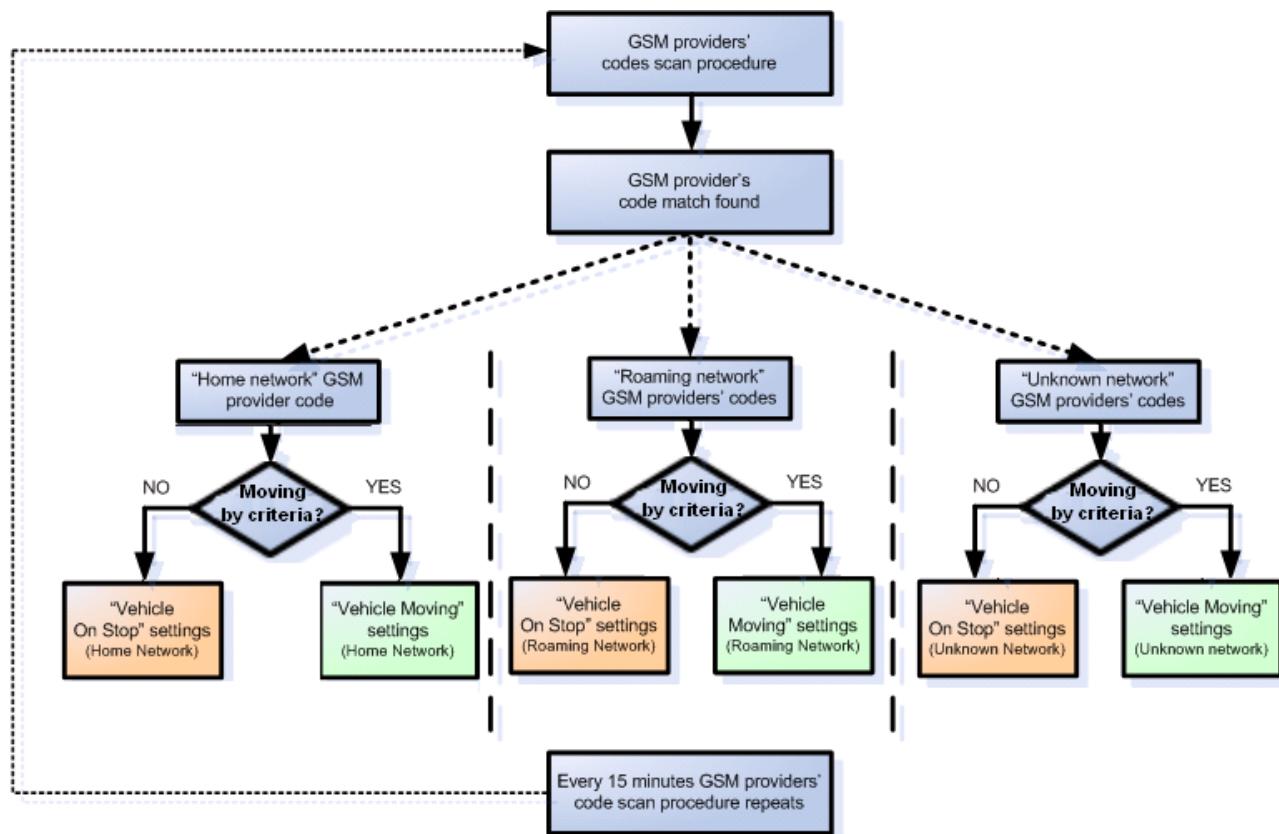

Figure 19 Data Acquisition Mode configuration

Operator search is performed every 15 minutes. Depending on current GSM operator, Home, Roaming or Unknown mode can be changed faster than every 15 minutes. This process is separate from operator search. Movement criteria are checked every second.

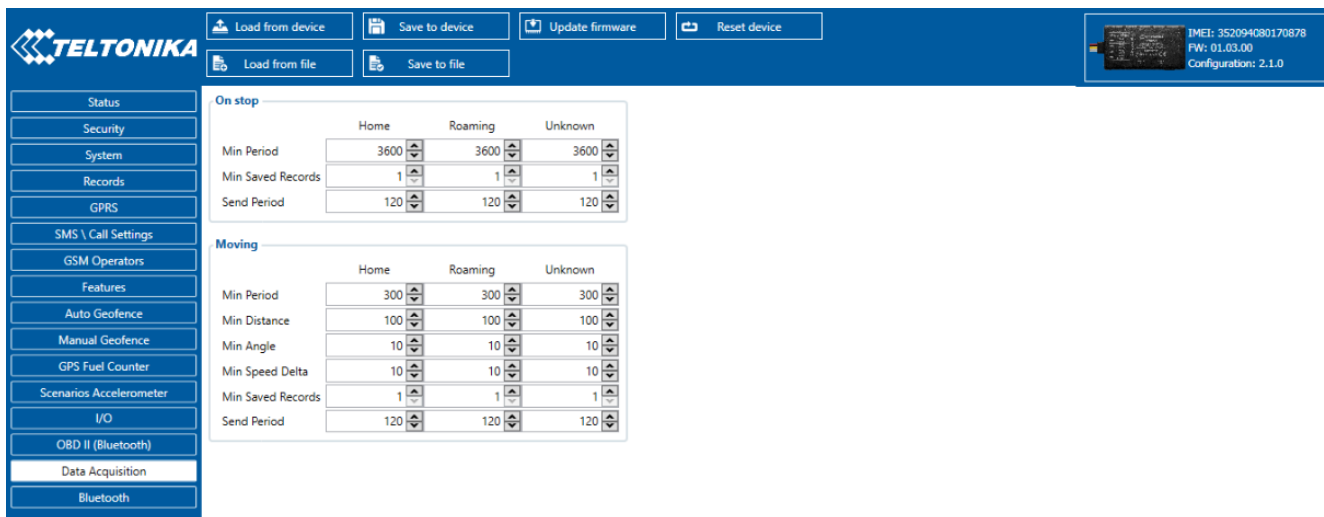

Figure 20 Data Acquisition Mode configuration

‘Min Saved Records’ defines minimum number of coordinates and I/O data that should be transferred with one connection to server. If FMB920 does not have enough coordinates to send to server, it will check again after time interval defined in ‘Sending Period’.

Send period – GPRS data sending to server period. Module makes attempts to send collected data to server every defined period. If it does not have enough records (depends on parameter Min. Saved Records described above), it tries again after defined time interval.



Note: Keep in mind that FMB920 operates in **GMT:0** time zone, without daylight saving.

FMB920 is able to collect records using four methods at the same time: time, distance, angle and speed based data acquisition:
 Time based data acquiring (Min. period) – records are being acquired every time when defined interval of time passes. Entering zero disables data acquisition depending on time.

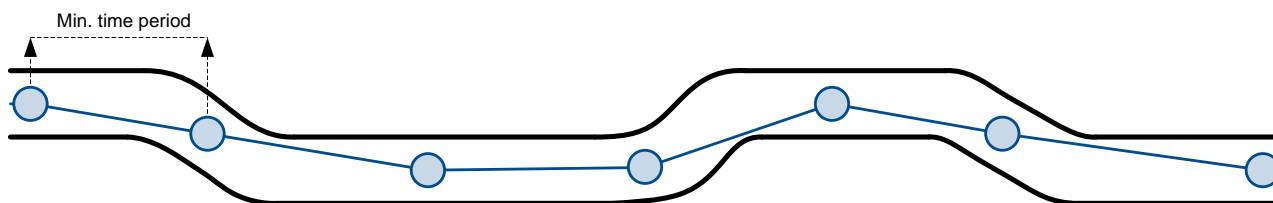

Distance based data acquiring (Min. distance) – records are being acquired when the distance between previous coordinate and current position is greater than defined parameter value. Entering zero disables data acquisition depending on distance.

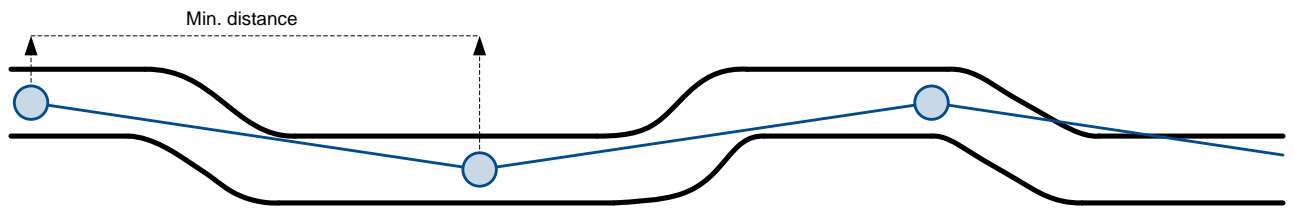

Angle based data acquiring (Min. angle) – records are being acquired when angle difference between last recorded coordinate and current position is greater than defined value. Entering zero disables data acquisition depending on angle.

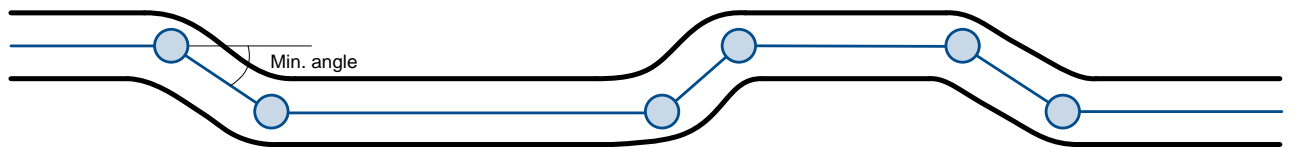

Speed based data acquiring (Min. Speed Delta) – records are being acquired when speed difference between last recorded coordinate and current position is greater than defined value. Entering zero disables data acquisition depending on speed.



5.11 Features settings

In Features window five different scenarios are available.

| Scenario | Priority | Max Acceleration (m/s ²) | Max Braking (m/s ²) | Max Cornering (m/s ²) | Max Speed (km/h) | Time To Stopped (s) | Time To Moving (s) | DOUT ON Duration (ms) | DOUT OFF Duration (ms) | Start Speed (km/h) | Ignition OFF Timeout (s) |
|------------------|--------------|--------------------------------------|---------------------------------|-----------------------------------|------------------|---------------------|--------------------|-----------------------|------------------------|--------------------|--------------------------|
| Green Driving | Disable | 2.2 | 2.5 | 2.1 | | 5 | 2 | 200 | 200 | | |
| | Low Priority | | | | | | | | | | |
| Over Speeding | Disable | | | | 90 | | | 200 | 200 | | |
| | Low Priority | | | | | | | | | | |
| Excessive Idling | Disable | | | | | 5 | 2 | 200 | 200 | | |
| | Low Priority | | | | | | | | | | |
| Jamming | Disable | | | | | | | 200 | 200 | | 60 |
| | Low Priority | | | | | | | | | | |
| Trip | Disable | | | | | | | | | 5 | 60 |
| | Low Priority | | | | | | | | | | |

Figure 21 Scenarios configuration

5.11.1 Green Driving

Scenario is activated and DOUT1 is ON, when vehicle exceeds on of Max. Acceleration, Max Braking or Max Cornering parameters value. You can configure all three parameters in m/s^2 (meter per second squered) units. Scenario is activated until current Acceleration, Braking or Cornering value decreases below parameter value.

Event Duration settings, if enabled, additional record with Green/Eco Driving event duration (ms) will be saved and send to server.

Parameters used with Green Driving functionality.

Green Driving

Scenario Settings

| | |
|---------------|----------------|
| Disable | Low Priority |
| High Priority | Panic Priority |

Max Acceleration (m/s^2)

Max Braking (m/s^2)

Max Cornering (m/s^2)

Source

| | |
|-----|---------------|
| GPS | Accelerometer |
|-----|---------------|

Green Driving Duration

| | |
|---------|--------|
| Disable | Enable |
|---------|--------|

Output Control

| | |
|------|--------|
| None | DOUT 1 |
|------|--------|

DOUT ON Duration (ms)

DOUT OFF Duration (ms)

Send SMS To

SMS Text

Figure 22 Green Driving configuration parameters

Table 6 Green Driving parameters description

| Green driving configuration parameter name | Description |
|--|--|
| Scenario settings | Enable/Disable Green driving functionality. |
| Max Acceleration Force | Value which can be reached while accelerating without triggering harsh acceleration event. |
| Max Braking Force | Value which can be reached while braking without triggering harsh braking event. |
| Max Cornering Force | Value which can be reached while cornering without triggering harsh cornering event. |

| | |
|--------|---|
| Source | From what source (GPS or accelerometer) data will be collected. |
|--------|---|

5.11.1.1 Data output

Green driving functionality generates events on three cases. If vehicles:

- Acceleration exceeds defined parameter value
- Deceleration (braking) exceeds defined value
- Cornering force exceeds defined value

Program continuously monitors and process data from accelerometer/GPS than decides whether harsh event is detected or not. If any of three cases are satisfied event is generated. Record is saved and sent to server (FMB920 must be configured properly). Event value is multiplied by 10 before sending/saving record to get more precision when displaying **data***.

Digital output No.1 is activated for a period of time to warn driver. Output on-time should/can be configured separately for each case.

***Example.** If acceleration harsh event of 3.55 m/s² detected. Record with value $3.55 * 10 = 35.5 \approx 36$ will be saved and sent to server.

5.11.1.2 Auto Calibration

1. Vehicle stopped
2. Road is straight
3. Send SMS "auto_calibrate:set"
4. Accelerate to > 30 km/h for 5 sec.
5. FMB will send response when calibration is success.

Calibration is saved to Internal Flash, after restart should be the same

To check autocalibration status send: auto_calibrate:get

5.11.2 Over Speeding

Scenario is activated and DOUT1 is ON, when vehicle speed exceeds parameter value. Scenario is activated until current speed decreases below parameter value.

5.11.3 Excessive Idling

Scenario is activated and DOUT1 is ON, when vehicle stops for specific amount of time. You can configure time it takes to turn on this scenario (Time to Stopped). Scenario is activated until vehicle starts moving and keeps moving (moving is detected only from accelerometer) for amount of time that is configured. You can configure time it takes to turn OFF this scenario (Time to Stopped).

5.11.4 Jamming

Scenario is activated and DOUT1 IS ON, then jamming is detected.

Jamming timeout time can be configures. After Jamming trigger count configured timeout (in seconds), DOUT1 control and jamming event will be generated after this timeout. If Jamming ends during timeout counting no event will be generated and output will not be controlled.

You can configure eventual records parameter: when he is disabled scenario status value will be appeared in each AVL record, and when he is enabled scenario status value will be appended only to eventual records.

5.11.5 Use authorized numbers to control DOUT via call

Scenario is activated and DOUT1 IS ON, when call is received from number who is in authorized numbers list.

Call control

- When FMBXX is configured to control *DOUT1* device waits incoming call from configured secure number. If call is received FMBXX turns on *DOUT1* for user defined *Duration timeout (s)*. If *Duration timeout* set to „0“(s), *DOUT1* will be OFF.
- *DOUT1* can be turned off by *Duration timeout (s)* or by *DIN1 (DOUT deactivation settings)*.
- *DOUT1* can be turned off before *Duration timeout (s)* by selected *DIN (DOUT deactivation settings)*.
- *DOUT1* always will be ON, if *DOUT deactivation* set to *DIN1* for example, but *DIN1* will be never turned ON or set *Duration timeout* to *Max* value (2147483647) it is about 68 years.

In all scenarios Digital Output can be controlled independent from scenario.

DOUT ON Duration parameter shows for how long DOUT is set on after scenario is activated. DOUT OFF Duration parameter shows how much time should pass after DOUT is set off till next event can be generated. These parameters must be configured in ms.

5.11.6 Trip settings

Trip window offers user to configure Trip feature. If Trip is enabled configuration of parameters are enabled.

Start Speed (km/h) – GPS speed has to be greater than the specified Start Speed in order to detect Trip Start.

Ignition OFF Timeout (s) – timeout to wait if ignition (configured ignition source) was off, to detect Trip stop.

Distance counting mode – Between Records or Continuous can be chosen. For this feature I/O Trip Odometer must be enabled.

Eco Score allowed events – how much ECO events is allowed in 100 km. I/O Eco score must be enabled to get value into server. ECO scoring is differentiated by separate Trips.

There are six ECO evaluation events:

1. Harsh acceleration
2. Harsh braking
3. Harsh cornering

4. Over-speeding (count only events with value 1 (start) and ignore value 0(end))
5. Excessive Idling (count only events with value 1 (start) and ignore value 0(end))
6. High RPM

Eco score value can be from 10 (excellent) to 0.00 (very bad):

1. Excellent 8.00 – 10
2. Good 6.00 – 7.99
3. Not Good 4.00 – 5.99
4. Bad 2.00 – 3.99
5. Very Bad 0.00 – 1.99

Score evaluation is calculated like this:

$$\text{Eco score} = 10 / ((\text{Total events}) / (\text{Trip distance in km} * \text{Allowed events per km}))$$

$$\text{Allowed events per km} = (\text{Allowed events} / 100)$$



Note: when Total events < 1, we ignore formula and then Eco score is equal to 10.

If Allowed events is configured to 0, then

If (Total events > 0) Eco score value will be 0, else Eco score value will be 10.



Note: Score is updated every 1km driven or 5 minutes of trip duration.

If I/O Trip Odometer is enabled and Continuous distance counting variable (Mode) is set to Continuous, **Trip distance** is going to be counted continuously (**from Trip start to Trip stop**). This value is written to I/O Trip Odometer value field. When Trip is over and next Trip begins, Trip Odometer value is reset to zero. When the next trip starts counting continuously starts from the beginning again.

If I/O Trip Odometer is enabled and Continuous Distance Counting variable (Mode) is set "Between Records", then the distance is going to be counted only between every record made. This value is written to I/O Trip Odometer value field and reset to zero every new record until Trip stops. If later all Odometer values are summed up manually, the user gets the distance driven during the whole period of the Trip.

Trip

Scenario settings

| | |
|---------------|----------------|
| Disable | Low Priority |
| High Priority | Panic Priority |

Eventual Records

| | |
|---------|--------|
| Disable | Enable |
|---------|--------|

Mode:

| | |
|------------|-----------------|
| Continuous | Between Records |
|------------|-----------------|

Start Speed:(km/h)

Ignition OFF Timeout:(s)

Eco Score allowed events

Send SMS To

Sms text

Figure 23 Trip configuration

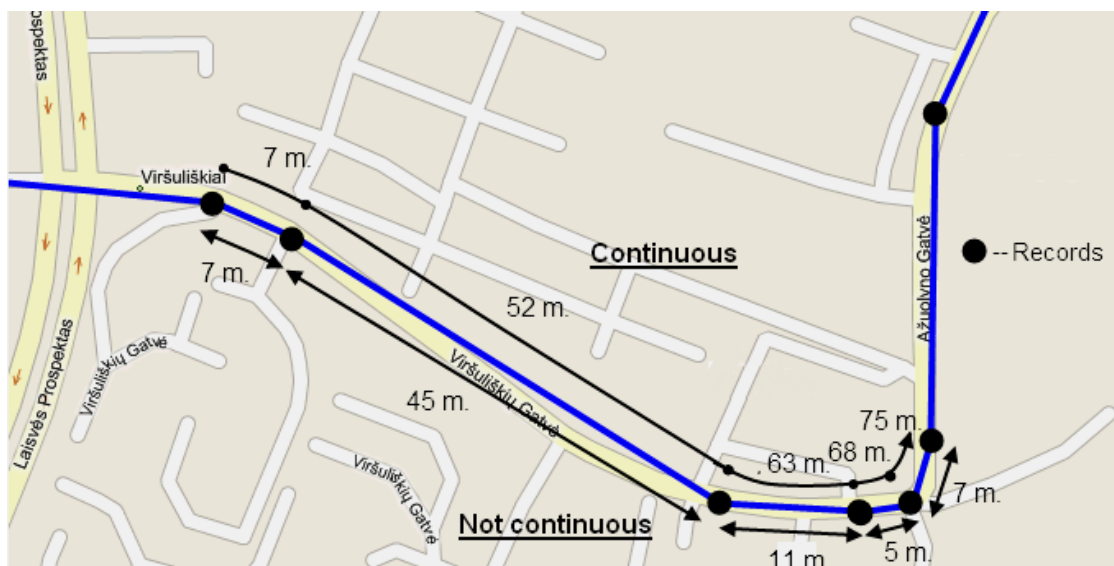

Figure 24 Trip continuous distance counting parameter example

5.11.7 DOUT control depending on functionality priority

All DOUT control functionalities now have their own priority (non-configurable). Depending on priority DOUT control may be overtaken by higher priority functionality without finishing previous scenario.

DOUT control scenarios and functionalities by priority:

1. DOUT control via call
2. Green Driving
3. Jamming
4. Overspeeding
5. Idling

6. DOUT control via SMS (lowest priority)

For example, if jamming will be detected during Overspeeding, then Jamming functionality will control DOUT.

5.12 AutoGeofencing settings

AutoGeofence – the last known position after movement = off. If your car's being taken away – you can be notified. The shape and size of the geofence zones are parameters. It is possibility to state whether entering in or out of the geofence triggers an asynchronous message.

AutoGeofencing option can be configured by following parameters visible in figure 25 below.

Activation Timeout (s) – when ignition is turned off and activation timeout passes, as AutoGeofence will be created around vehicle last position with set radius value.

Radius (m) – radius of circle with center device coordinates after activating AutoGeofence feature.

Deactivate By:

Digital Input 1 – If DIN1 voltage becomes equal or higher than 7,5 V it will disable AutoGeofence Zone.

Power Voltage – if power voltage become higher that low voltage level (Ignition settings) it will disable AutoGeofence Zone.

Engine RPM – If engine RPM became higher that 0 it will disable AutoGeofence Zone.

Feature – Priority of generated event, which will be applied to saved record.

Enter Event – Event generation on Geofence entrance.

Exit Event – Event generation on Geofence exit.

On Both - Event generation on Geofence entrance Or exit

Eventual Records – Enable or Disable Eventual Records functionality.

Note that AutoGeofencing does not require entering coordinates, instead it requires GPS visibility. If vehicle stopped and activation timeout has passed, an AutoGeofence will be created around vehicle's last position with set Radius value.

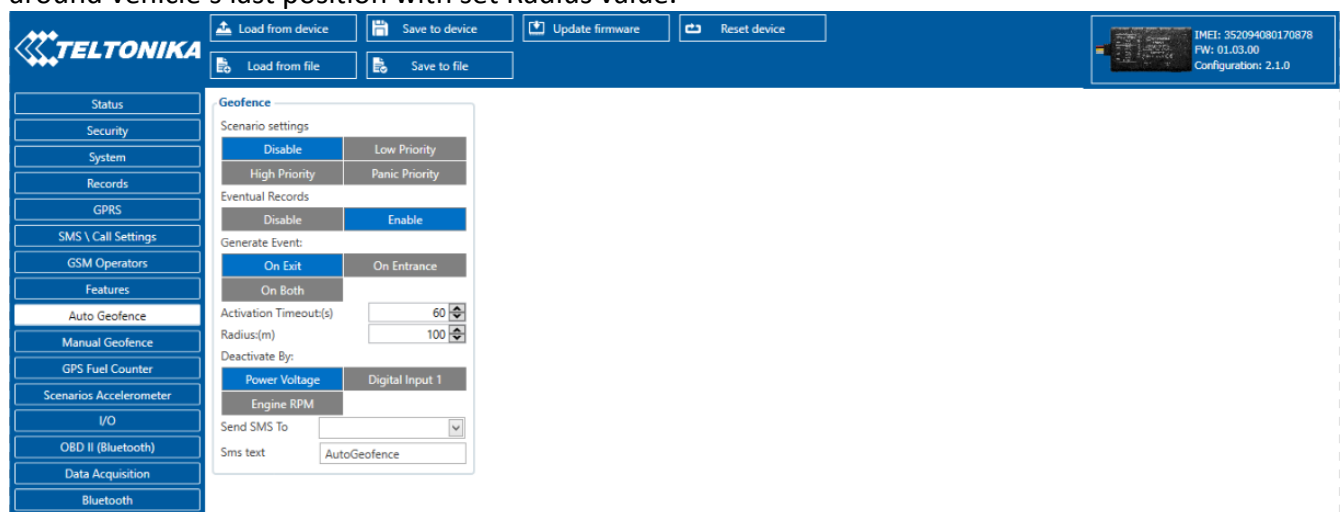

Figure 25 Auto Geofence configuration

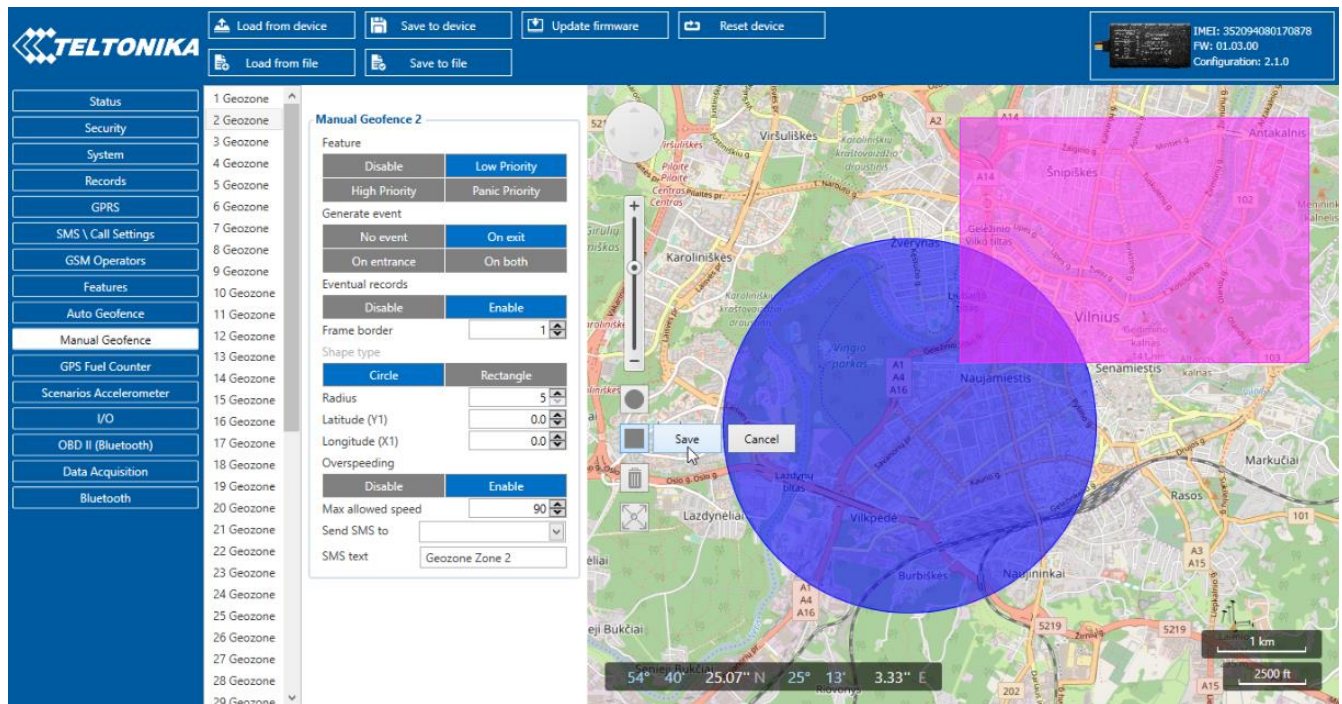

Figure 27 Geofence configuration

5.14 GPS Fuel Counter

Configuration of Fuel Consumption

- To configure this parameters use fuel consumption norm which are presented in your car technical documentation. By default speeds for this fuel consumption norms are: City – 30 km/h, Average - 60km/h, Highway - 90 km/h. If you want, you can change it.
- When speed are higher than highway fuel consumption speed, we add for highway fuel consumption x % of highway fuel consumption every y km/h, by default FMB920 add 20% every 50 km/h. It means that fuel consumption is $(1.2 * \text{Highway Fuel Consumption})$ on 140 km/h speed, $(1.4 * \text{Highway Fuel Consumption})$ on 190 km/h speed.
- Correction coefficient is use for correction every value of fuel consumption which is send to server ($\text{Used Fuel} * \text{Correction coefficient}$). By default it is 1, min 0.01 and max 2. For example when correction coefficient is 1 and FMB920 calculate that used fuel of 35 m distance is 20 ml, to server will be sent value: 20 ml, if correction coefficient is 1.2 to server will be sent value: $20 * 1.2 = 24$ ml.
- Fuel consumption on idling used to calculate fuel consumption when ignition is on, but vehicle speed is 0 km/h. By default it is 1 l/h, min 0 and max 5 l/h. Almost in all diesel cars this parameter is less than 1.0 l/h. In gasoline cars this parameter is about 1.5 – 2.0 l/h.

GpsFuelCounter

| | |
|----------------------------------|---------------------------------|
| City Consumption:(L/100km) | <input type="text" value="0"/> |
| Highway Consumption:(L/100km) | <input type="text" value="0"/> |
| Average Consumption:(L/100km) | <input type="text" value="0"/> |
| City Speed:(km/h) | <input type="text" value="30"/> |
| Highway Speed:(km/h) | <input type="text" value="90"/> |
| Average Speed:(km/h) | <input type="text" value="60"/> |
| Correction Coefficient | <input type="text" value="1"/> |
| Fuel Consumption on Idling:(L/h) | <input type="text" value="1"/> |
| Higher Speeds add:(%) | <input type="text" value="20"/> |
| Highway Consumption every:(km/h) | <input type="text" value="50"/> |

Figure 28 GPS Fuel Counter configuration

5.15 Scenarios Accelerometer

5.15.1 Unplug Detection

Unplug Detection. Eventual event will be generated when FMB920 is unplugged from external power or plugged back again. User can select detection type: simple – used in cars, where power voltage is not dependant on ignition (recommended); advanced – used in cars, where power voltage is disconnected when ignition is switched off.

Unplug

Scenario settings

| | |
|---|---|
| <input checked="" type="button" value="Disable"/> | <input type="button" value="Low Priority"/> |
| <input type="button" value="High Priority"/> | <input type="button" value="Panic Priority"/> |

Eventual Records

| | |
|--|--|
| <input type="button" value="Disable"/> | <input checked="" type="button" value="Enable"/> |
|--|--|

Unplug Detection Mode:

| | |
|--|---|
| <input checked="" type="button" value="Simple"/> | <input type="button" value="Advanced"/> |
|--|---|

Send SMS To

Sms text

Figure 29 Unplug detection configuration

5.15.2 Towing Detection

FMB920 activates towing function when these conditions are met:

- Ignition (configured Ignition Source) is OFF.
- Activation Timeout (set in Towing detection features) is reached.

When Activation Timeout is reached and Ignition is still in OFF state, FMB920 monitors accelerometer data. If Acceleration or Angle value reaches configured threshold for configured Duration (in ms), check Ignition state. If Ignition is still OFF during configured "Ignition check after Event Timeout" time, then event is generated. If configured - sends sms event or makes a call. Function will be reactivated after FMB920 again detects change of Ignition state from ON to OFF.

Activation timeout – Activation timeout is time after which FMB920 turns ON Towing detection function if other requirement is met (Ignition OFF state detected). It is measured in minutes.

Event timeout – defines time period (in seconds) to check ignition state when Acceleration or Angle value reach. If towing event is generated during this time period, it is skipped. It allows filtering out redundant towing events while entering the car.

Make Call to – if function enabled makes call to specified phone number (configured in predefined numbers).

Threshold and Angle – values used to detect towing when ignition is OFF.

Duration – defines time period to check Acceleration and Angle values.

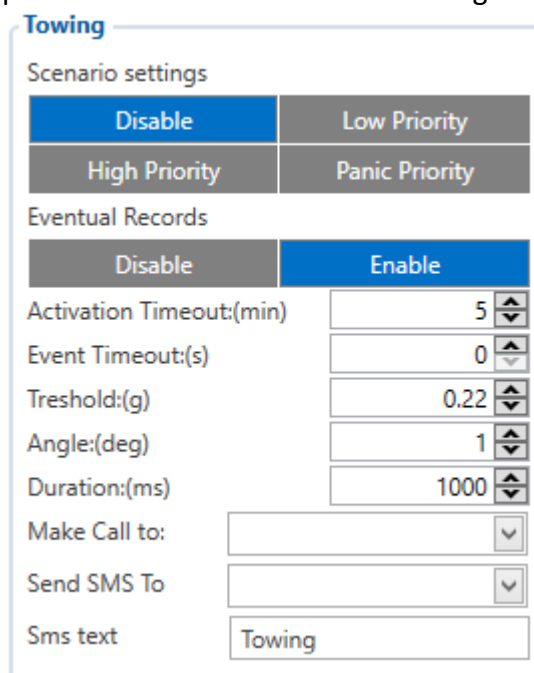

Towing

Scenario settings

| | |
|---------------|----------------|
| Disable | Low Priority |
| High Priority | Panic Priority |

Eventual Records

| | |
|---------|--------|
| Disable | Enable |
|---------|--------|

Activation Timeout:(min)

Event Timeout:(s)

Treshold:(g)

Angle:(deg)

Duration:(ms)

Make Call to:

Send SMS To

Sms text

Figure 30 Towing detection configuration

5.15.3 Crash Detection

Crash Detection functionality can be set according to these settings:

- Threshold (mg)
- Duration (ms)

If accident happens and FMB920 detects acceleration value higher than set threshold value during set time period, then device will generate an event. Threshold and duration values are set depending of accident power which you want to detect. FMB920 can detect a slight tapping on the device (Threshold=100mg, Duration=1ms) or can detect severe accident (Threshold=4000mg, Duration=5ms).

Crash Trace operation:

If trace is enabled FMB will collect acceleration data every 40 msec., and in the deep-sleep mode too. Buffer is big enough to hold data for 5 seconds and on Crash Event detection, records will be generated from this buffer, following these conditions:

- Every second Acceleration changed more then > 50mG.
- Data will be collected and records generated 5 seconds after the event using the same conditions.
- Every generated record will have accelerometer X Y Z values included.

- Each record will have accurate timestamps in milliseconds. Usually between 20 to 30 records is generated on crash event detection.

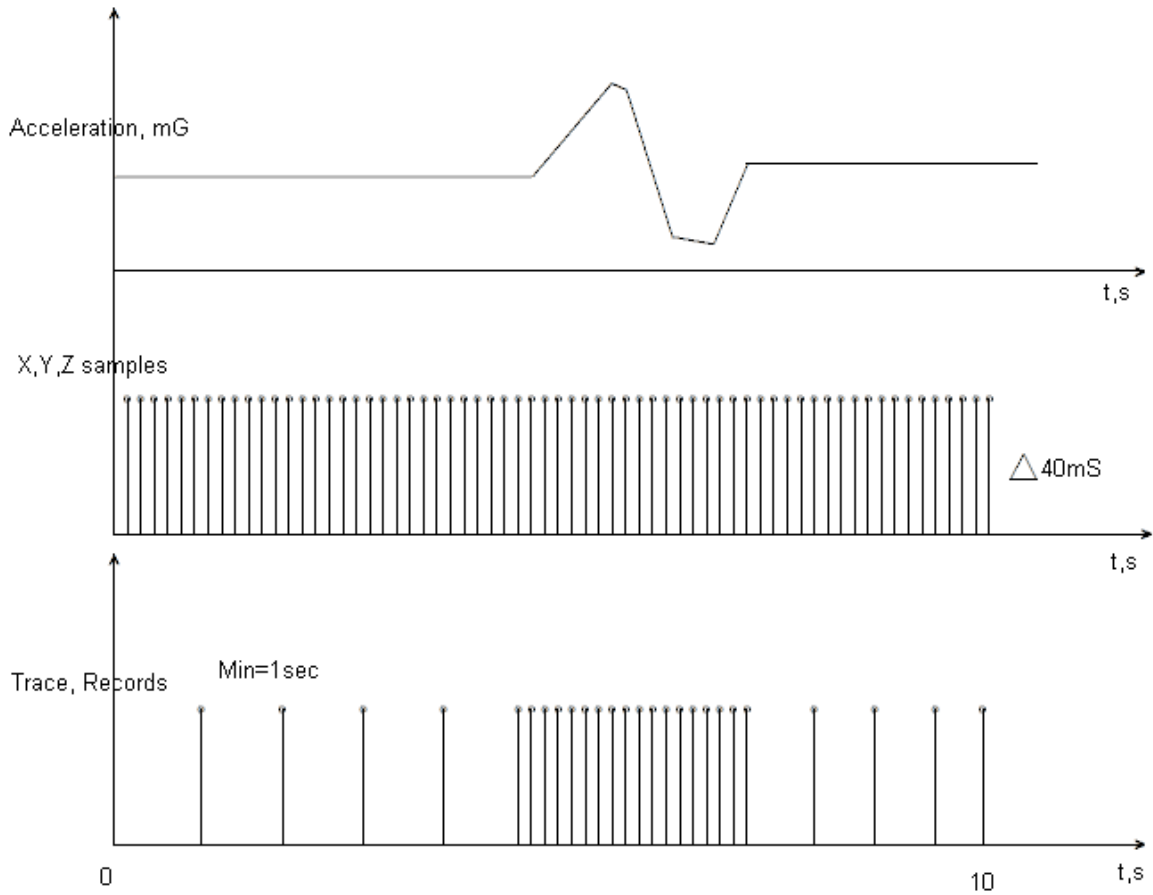

Figure 31 example of Crash Trace logic

5.16 Bluetooth

General

BT Radio

| | |
|------------------|-----------------|
| Disable | Enable (hidden) |
| Enable (visible) | |

Local Name

Local PIN

Security Mode

| | |
|---------------|----------------|
| PIN only | PIN + MAC list |
| MAC list only | None |

Auto Connect to External Device

Connection Mode

| | |
|-------|------------|
| None | Hands Free |
| OBDII | Data Link |

External MAC

External Name

External PIN

Authorized Devices MAC List

| | |
|---|--|
| 1 | |
| 2 | |
| 3 | |
| 4 | |
| 5 | |

Figure 32 Bluetooth general functionality

5.16.1 General functionality

General functionality configures Bluetooth to work in *slave* mode. This mode allows any external device to connect to FMBXX.

Parameter *BT Radio* allows user to select if he wants to enable or disable Bluetooth. There are three different scenarios:

- Disabled – Bluetooth functionality will be disabled.
- Enable (hidden) – Bluetooth functionality will be enabled, but none of external devices will be able to detect FMBXX but will be able to connect.



NOTE: FMBXX supports ONE connection at a time.
NOTE: FMB920 can see up to 10 available devices. If there are more than 10, with each scanning the list may change.

- Enable (visible) – Bluetooth functionality will be enabled and any external device will be able to detect and connect to FMBXX.
- *Local Name* parameter lets user to declare visible name of FMBXX to external devices.
- *Local PIN* parameter lets user to configure Bluetooth PIN of FMBXX device.

FMBXX Bluetooth has several different *security modes*:

- PIN only – while external device trying to connect to FMBXX only *Local PIN* will be reacquired to complete connection.
- PIN + MAC list – while external device trying to connect to FMBXX *Local PIN* and *Authorized Devices MAC List* will be checked. If external device MAC ID is in the list and correct *Local PIN* is entered then connection will be established, else FMBXX will reject connection.
- MAC list only – while external device trying to connect to FMBXX only *Authorized Devices MAC List* will be checked. If external device MAC ID is in the list then connection will be established, else FMBXX will reject connection.
- None – while external device trying to connect to FMBXX neither *Local PIN* or *Authorized Device MAC list* will be checked.

Auto Connection to External Device functionality

Auto connection functionality configures FMBXX as *master* device, this allows FMBXX connect to external device. FMBXX currently supports these modes:

- None – disables auto connection functionality.
- Hands Free – FMBXX starts to search external hands free headset. If FMBXX finds device which matches user defined *External MAC* or *External Name* then FMBXX will try to pair with that external device. If external device asks for PIN then FMBXX will send user defined *External PIN*. After successfull pairing FMBXX will connect to paired device.



NOTE: FMBXX supports ONE connection at a time.

NOTE: FMB920 can see up to 10 available devices. If there are more than 10, with each scanning the list may change.

- OBDII – FMBXX starts to search external OBDII Bluetooth dongle. If FMBXX finds device which matches user defined *External MAC* or *External Name* then FMBXX

will try to pair with that external device. If external device asks for PIN then FMBXX will send user defined *External PIN*. After successful pairing FMBXX will connect to paired device.

- Data Link – BT Data link mode is enabled by Configurator “Data Link” parameter: When Data Link is configured and FMB has a link with server, paired device could send messages via Bluetooth SPP profile directly to server. Messages will be encoded by codec12.



NOTE: FMBXX supports ONE connection at a time.

NOTE: FMB920 can see up to 10 available devices. If there are more than 10, with each scanning the list may change.

External Name parameter works as substring, this allows user to enter part of the full external device name. For example, if external device name is "HandsFreeHeadset" and user enters "HandsFree" in *External Name* parameter window then FMBXX will be allowed to connect to external device named "HandsFreeHeadset".

5.17 How to connect Bluetooth Hands Free adapter to FMB device

5.17.1 Bluetooth settings configuration

These are instructions how to easily prepare Bluetooth Hands Free device connection to FMB device. First we need to configure FMB device Bluetooth settings for proper connection to this hands-free unit. These are required steps:

1. Connect FMB device to PC using USB cable.
2. Launch **FMB Configurator** and connect to device as shown in **Figure 33** below.



Figure 33 FMB920 configurator connected devices window

3. After successful connection to device wait few moments while device load current configuration, then go to Bluetooth section that visible at **Figure 34**

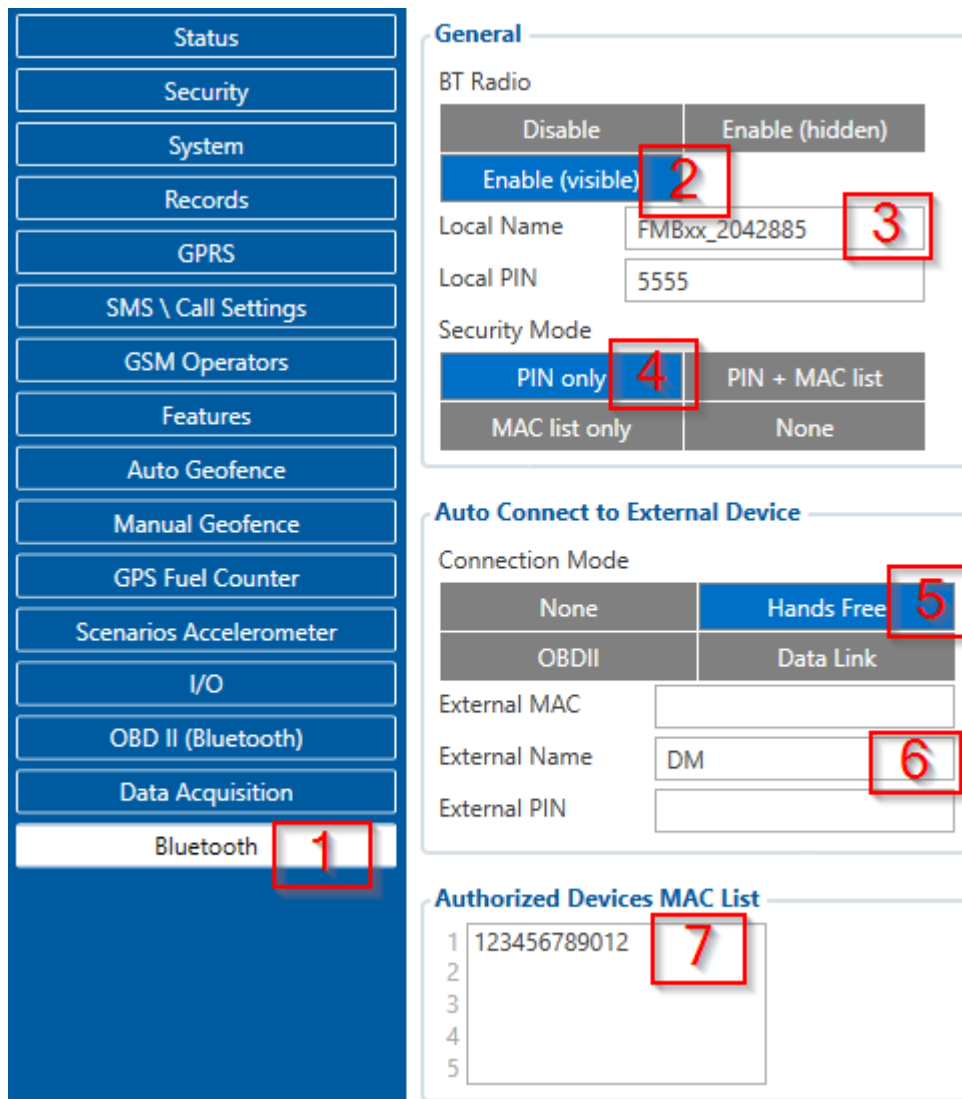

Figure 34 1- Bluetooth settings; 2 - Enable Bluetooth; 3 - Bluetooth local name; 4 - Bluetooth security mode; 5 - Hands Free connection mode; 6 - External Bluetooth device name; 7 - Authorized Devices MAC List;

4. When device configuration is loaded press „**Bluetooth**“ settings (**Figure 34** 1 position).
5. Turn on BT Radio by pressing „**Enable (visible)**“ (**Figure 34** 2 position). „**Local name**“ (**Figure 34** 3 position) automatically will be “FMBxx_last 7 imei digits”, you can leave it or type your own name.
6. Set Security Mode (**Figure 34** 4 position) to “**PIN only**” or “**None**” (you could select “**PIN + MAC list**” or “**MAC list only**” security mode but in this case you need to type external device MAC address in “**Authorized Devices MAC List**” (**Figure 34** 7 position).
7. Set connection mode to “**Hands Free**” (**Figure 34** 5 position).
8. Set „**External Name**“ (**Figure 34** 6 position) as your Hands Free device name for proper device identification and connection to it. In this example Hands Free headset name is „DMH10“ but at least 2 characters are needed to recognize it and connect to it. For better and faster adapter identification in network you could enter a full device name. You could check your Hands Free adapter Bluetooth name by scanning nearby Bluetooth devices using mobile phone or computer with Bluetooth adapter.

9. Go to “SMS \ Call Settings” in left menu and set “Incomming Call Action” to “Do Nothing” visible at **Figure 35**.

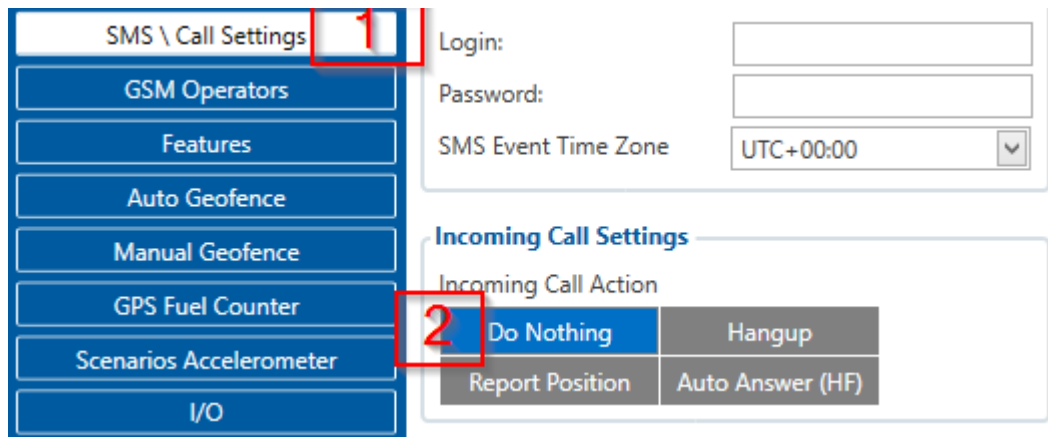

Figure 35 Incoming Call Action settings

10. After all these steps press „Save to device“ to save configuration.
11. Now you can disconnect FMB device from a configurator.

5.17.2 Connecting Bluetooth Hands Free adapter

After this configuration you could connect your Hands Free device to FMB device. Turn on Hands Free device then turn on its Bluetooth connection for pairing following your model instructions⁴. Hands Free adapter should make a special sound in ear from speaker or its led identification should change to inform about successful connection⁵. To check if adapter is successfully connected, call to FMB device, Hands Free device should start ringing. If you later restart FMB device it will automatically connect to this adapter.

5.18 Device's log using your mobile phone.

When FMB device starts, automatically Bluetooth is ON too. Take your mobile phone, go to settings>Bluetooth and turn it on. Scan for near by devices, find you device in list, distinguish device by last IMEI numbers on device module. Press pair, wait until device will ask to enter pairing password, type: 5555. Paired device will show up in paired device list. Now download from play store/app store terminal for Bluetooth. E.g BlueTerm. Run app, click find>connect to your paired device. Now we need to send command to FMB920 from Bluetooth terminal, type: .log:1

Device will respond Debug enabled and FMB920 log will how up. Do not forget to start save log file to mobile phone.

⁴ Hands Free device Bluetooth connection pairing instructions depends on specific model.

⁵ Hands Free device notification about paired Bluetooth connection depends on specific model.

5.19 Device debug over Android smartphone

1. Scan for visible BT devices using your Android smartphone and connect to your FMB device.

Default FMB BT name: **FMBxx_last_7_imei_digits**

Default PIN code: **5555**

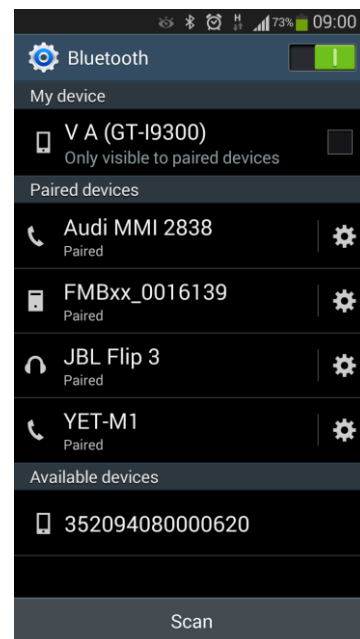

2. Download “Bluetooth Terminal” application. You can use link or QR code shown here:

<https://play.google.com/store/apps/details?id=com.hatflabs.btt>



3. Run Bluetooth Terminal. In menu press “Connect” button and select paired FMB device. To start log check CR and enter the command in terminal: **.log:1**

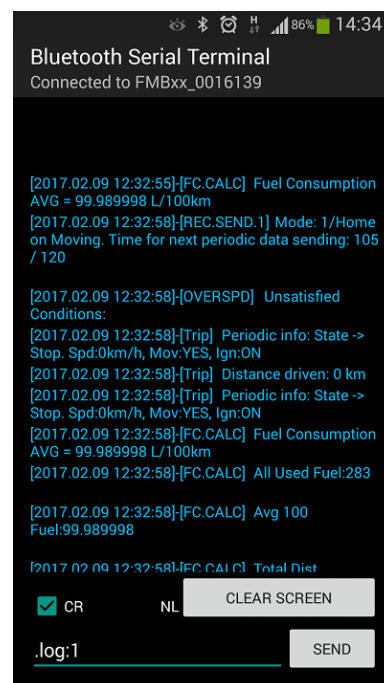

4. Wait ~10 minutes and press “Save” button in menu. You will find saved log file in device

folder (My Files/Bluetooth Terminal), select log files and press button Share via Email and send them to the Teltonika support.

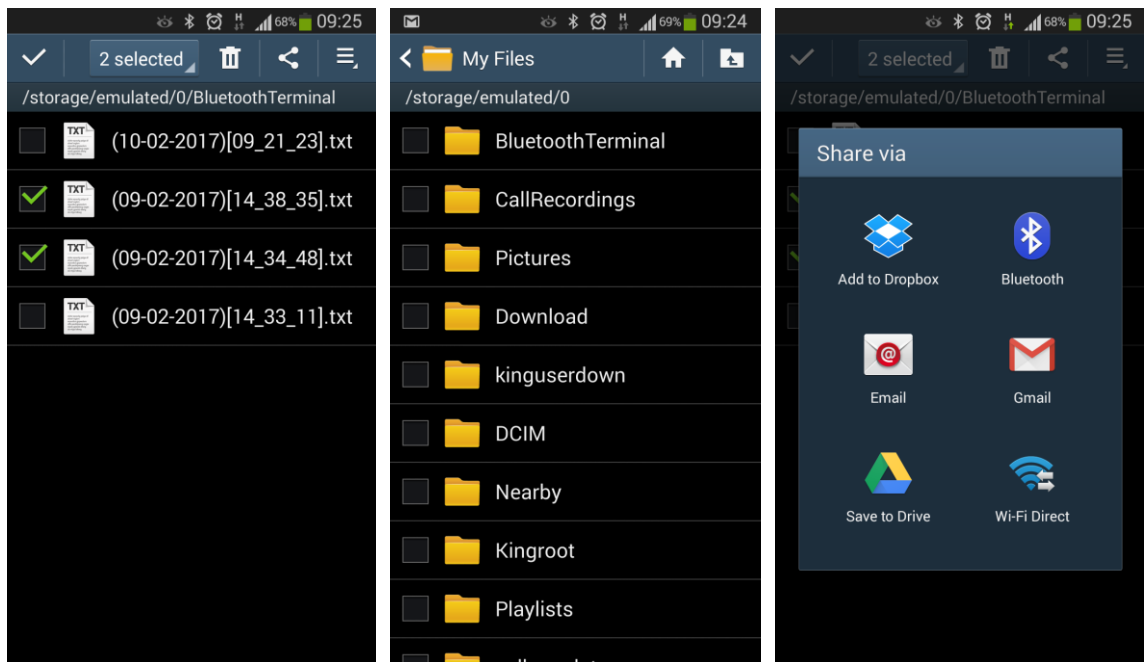

In order to pair FMB device with Android smartphone, make sure that BT radio is enabled (visible) in device configuration. It can be checked via SMS command too:

getparam 800

The answer has to be 2, which means "Enabled and visible".

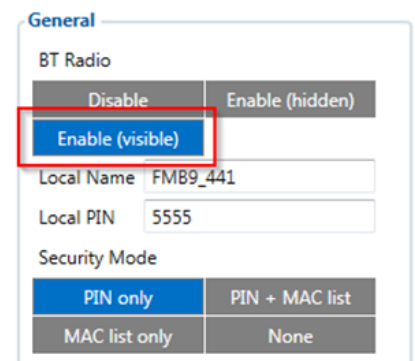

Note: Unfortunately it is not possible to do the same on iPhone, because there is no native SPP Bluetooth profile support in iPhone.



5.20 How to connect OBD II Bluetooth Dongle to FMB device

5.20.1 Bluetooth settings configuration

These are instructions how to easily prepare Bluetooth Dongle connection to FMB device. First we need to configure FMB device Bluetooth settings for proper connection to this unit. These are required steps:

1. Connect FMB device to PC using USB cable.
2. Launch **FMB Configurator** and connect to device as shown in **Figure 33** below.

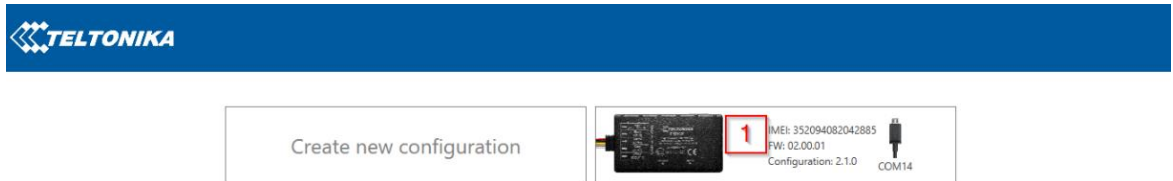

Figure 36 FMB920 configurator connected devices window

3. After successful connection to device wait few moments while device load current configuration, then go to Bluetooth section that visible at **Figure 37**.

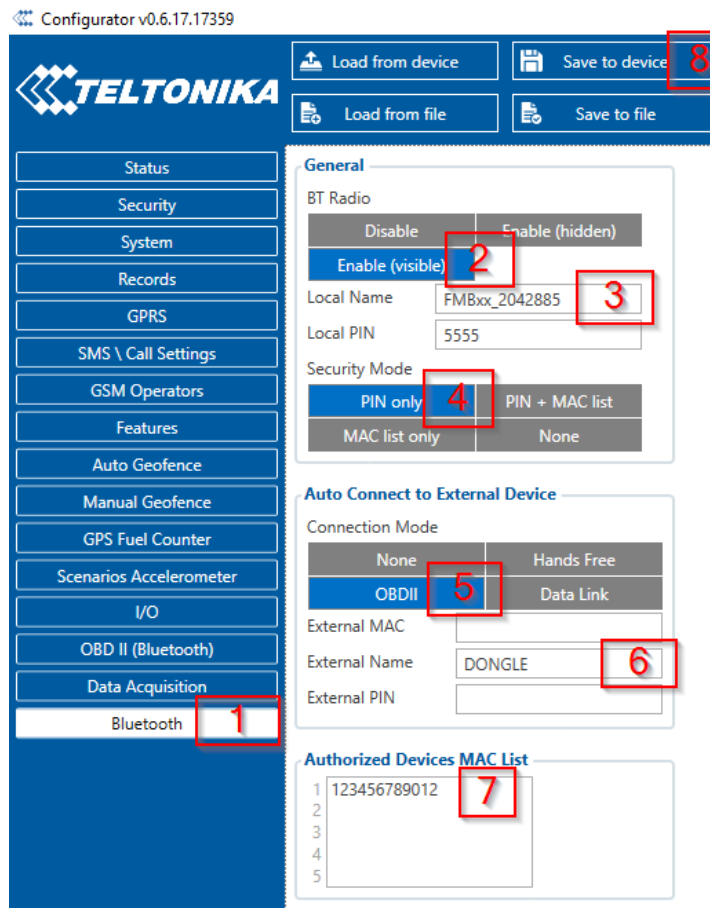

Figure 37 1- Bluetooth settings; 2 - Enable Bluetooth; 3 - Bluetooth local name; 4 - Bluetooth security mode; 5 - OBD II connection mode; 6 - External OBD II Bluetooth device name; 7 - Authorized Devices MAC List; 8 - Save device configuration

4. When device configuration is loaded press „Bluetooth“ settings (Figure 37 1 position).
5. Turn on BT Radio by pressing „Enable (visible)“ (Figure 37 2 position). „Local name“ (Figure 34 3 position) automatically will be „FMBxx_last 7 imei digits“, you can leave it or type your own name.
6. Set Security Mode (Figure 37 4 position) to „PIN only“ or „None“ (you could select „PIN + MAC list“ or „MAC list only“ security mode but in this case you need to type external device MAC address in „Authorized Devices MAC List“ (Figure 37 7 position).
7. Set connection mode to „OBDII“ (Figure 37 5 position).
8. Set „External Name“ as your Bluetooth OBD II device name for proper device identification and connection to it. In this example OBD II device name is „DONGLE“ but at least 2 characters are needed to recognize it and connect to it. For better and faster adapter identification in network you could enter a full device name. You could check your OBD II adapter Bluetooth name by scanning nearby Bluetooth devices using mobile phone or computer with Bluetooth adapter.
9. Go to „OBD II (Bluetooth)“ in left menu and select priority and others parameters visible at Figure 38.

| Input name | Units | Priority | Low level | High level | Event only | Operand | Send SMS to | SMS Text |
|-----------------------------|-------|---------------------|-----------|------------|------------|------------|-------------|------------------------------|
| Number Of DTC | | None Low High Panic | 0 | 0 | Yes No | Monitoring | | Number of DTC |
| Engine Load | % | None Low High Panic | 0 | 0 | Yes No | Monitoring | | Calculated engine load value |
| Coolant Temperature | °C | None Low High Panic | 0 | 0 | Yes No | Monitoring | | Engine coolant temperature |
| Short Fuel Trim | % | None Low High Panic | 0 | 0 | Yes No | Monitoring | | Short term fuel trim 1 |
| Fuel Pressure | kPa | None Low High Panic | 0 | 0 | Yes No | Monitoring | | Fuel pressure |
| Intake MAP | kPa | None Low High Panic | 0 | 0 | Yes No | Monitoring | | Intake MAP |
| Engine RPM | rpm | None Low High Panic | 0 | 0 | Yes No | Monitoring | | Engine RPM |
| Vehicle speed | km/h | None Low High Panic | 0 | 0 | Yes No | Monitoring | | Vehicle speed |
| Timing advance | ° | None Low High Panic | 0 | 0 | Yes No | Monitoring | | Timing advance |
| Intake air temperature | °C | None Low High Panic | 0 | 0 | Yes No | Monitoring | | Intake air temperature |
| MAF | g/sec | None Low High Panic | 0 | 0 | Yes No | Monitoring | | MAF rate |
| Throttle position | % | None Low High Panic | 0 | 0 | Yes No | Monitoring | | Throttle position |
| Run time since engine start | s | None Low High Panic | 0 | 0 | Yes No | Monitoring | | Run time since engine start |
| Distance traveled MIL on | km | None Low High Panic | 0 | 0 | Yes No | Monitoring | | Distance traveled MIL on |
| Relative fuel rail pressure | kPa | None Low High Panic | 0 | 0 | Yes No | Monitoring | | Relative fuel rail pressure |
| Direct fuel rail pressure | kPa | None Low High Panic | 0 | 0 | Yes No | Monitoring | | Direct fuel rail pressure |
| Commanded EGR | % | None Low High Panic | 0 | 0 | Yes No | Monitoring | | Commanded EGR |
| EGR error | % | None Low High Panic | 0 | 0 | Yes No | Monitoring | | EGR error |
| Fuel level | % | None Low High Panic | 0 | 0 | Yes No | Monitoring | | Fuel level |

Figure 38 OBD II Bluetooth settings.

10. After all these steps press „Save to device“ to save configuration (Figure 37 8 position).
11. Now you can disconnect FMB device from a configurator.

5.20.2 Connecting to Bluetooth OBD II dongle

After this configuration you could connect your car OBD II dongle to FMB device. Turn on ignition then turn on its Bluetooth connection. For pairing follow your dongle instructions⁶. OBD II device notification about paired Bluetooth connection depends on specific model. If you later restart FMB device it will automatically connect to this dongle.

⁶ OBD II dongle Bluetooth connection pairing instructions depends on specific model.

5.20.3 Supported Bluetooth OBD II dongles

FMB module works with Bluetooth OBD II dongles which are made with **ELM327** or **STN1110** chips.

Comparison of these chips is presented in **Figure 39**.

| | ELM327 v1.4 | STN1110 |
|--|----------------------|--------------------------|
| Base microcontroller | PIC18F2580 | PIC24HJ128GP502 |
| Architecture | 8-bit | 16-bit |
| Processing speed | 4 MIPS | 40 MIPS |
| Flash (ROM) | 32 KB | 128 KB |
| RAM | 1.5 KB | 8 KB |
| Pin count | 28 | 28 |
| Available packages | PDIP, SOIC | PDIP, SOIC, QFN |
| Supply voltage range | 4.5 to 5.5V | 3.0 to 3.6V ¹ |
| Supports all OBD-II protocols | yes | yes |
| ELM327 command set | yes | yes |
| Enhanced "ST" command set | no | yes |
| Firmware upgradeable | no | yes |
| Large OBD message memory buffer | no | yes |
| Low power mode | yes | yes |
| Supported UART baud rates | 9600 bps to 500 kbps | 38 bps to 10 Mbps |
| OBD message filtering | basic | advanced |

Figure 39 ELM327 and STN1110 comparison.

5.21 SMS events

SMS events functionality allows FMB920 to send a configured SMS when an event is triggered. This event can be triggered by every I/O element.

Then any of the I/O elements is triggered, FMB920 sends a configured SMS message to a defined phone number. If SMS events is activated, but there are no numbers defined in GSM PreDefined Numbers list (figure 40), then the device will not send any messages.

The screenshot shows the 'SMS \ Call Settings' menu on the left. The main area is divided into three sections:

- Login:** Fields for Login, Password, and SMS Event Time Zone (set to UTC+00:00).
- Incoming Call Settings:** Incoming Call Action buttons: Do Nothing, Hangup, Report Position, and Auto Answer (HF).
- Hands Free Call Settings:** Outgoing Call Trigger buttons: DIN 1 and Crash Event, and a GSM Number dropdown.

On the right, there are two lists of numbers, each with a vertical scroll bar and numbers 1-10:

- Top list: 8, 9, 10
- Bottom list: 1, 2, 3, 4, 5, 6, 7, 8, 9, 10

Figure 40 GSM PreDefined Numbers list

The sent SMS messages format is according to:

“Date Time Current Coordinate Event Text”

For example, if FMB920 is configured to send an SMS, when Ignition reaches High level, with priority High and configured to generate event on both range enter and exit (figure 41), then the sent SMS is:

“2017/06/13 13:52:18 Lon:25.255537 Lat:54.667193 Ignition 1”

| Input name | Current value | Priority | Low level | High level | Event only | Operand | Avg const | Send SMS to | SMS Text |
|------------------|---------------|---------------------|-----------|------------|------------|------------|-----------|--------------|------------------|
| Ignition | 0 | None Low High Panic | 0 | 0 | Yes No | On both | 0 | +37060123456 | Ignition |
| Movement | 0 | None Low High Panic | 0 | 0 | Yes No | On change | 1 | | Movement |
| Data Mode | 0 | None Low High Panic | 0 | 0 | Yes No | Monitoring | | | Data Mode |
| GSM Signal | 4 | None Low High Panic | 0 | 0 | Yes No | Monitoring | 1 | | GSM Signal |
| Deep Sleep | 0 | None Low High Panic | 0 | 0 | Yes No | Monitoring | | | Deep Sleep |
| GNSS Status | 1 | None Low High Panic | 0 | 0 | Yes No | Monitoring | | | GNSS Power |
| GNSS PDOP | 0 | None Low High Panic | 0 | 0 | Yes No | Monitoring | 10 | | GNSS PDOP |
| GNSS HDOP | 0 | None Low High Panic | 0 | 0 | Yes No | Monitoring | 10 | | GNSS HDOP |
| External Voltage | 12710 | None Low High Panic | 0 | 0 | Yes No | Monitoring | 10 | | External Voltage |
| Speed | 0 | None Low High Panic | 0 | 0 | Yes No | Monitoring | 1 | | Speed |
| GSM CellID | 3054 | None Low High Panic | 0 | 0 | Yes No | Monitoring | | | GSM Cell ID |
| GSM Area Code | 1 | None Low High Panic | 0 | 0 | Yes No | Monitoring | | | GSM Area Code |

Figure 41 Configured Ignition SMS event

The SMS Text field can be altered and any text can be entered. Maximum message length is 90 symbols (numbers, letters and symbols in ASCII, except for comma “,”).



ATTENTION!

If FMB920 is in Deep Sleep mode and SMS event occurs with LOW priority (which does not wake up FMB920), then the device does not send the message. It is saved in device memory until it wakes up from Deep Sleep mode and GSM modem starts working normally. After it wakes up, all the messages that are

saved in memory will be sent, but keep in mind that only 10 messages can be saved in memory – all other messages will not be saved, until there is room in device memory.

5.22 I/O settings

When no I/O element is enabled, AVL packet comes with GNSS information only. After enabling I/O element(s) AVL packet along with GNSS information contains current value(s) of enabled I/O element.

Current value – if device is connected to configurator all current I/O values are displayed in this column.

Priority field – allows enabling I/O element and set them priority so it is added to the data packet and is sent to the server. By default 12 I/O elements with low priority are enabled: Ignition, Movement, Data Mode, GSM Signal, Sleep mode, GNSS Status, GNSS PDOP, GNSS HDOP, External Voltage, Speed, Battery Voltage and Battery Current. Priority (AVL packet priority) can be Low, High or Panic. All records made by FMB920 are regular. Regular packets are sent as Low priority records. When low priority event is triggered, FMB920 makes additional record with indication that the reason for that was I/O element change (depends from Operand configuration). When High priority is selected, module makes additional record with high priority flag and sends event packet immediately to the server by GPRS. Panic priority triggers same actions as high priority, but if GPRS fails, it sends AVL packet using SMS data sending mode if **SMS data sending is enabled and data send number is written in SMS \ Call Settings.**

High and Low levels – define I/O value range. If I/O value enters or exits this range, FMB920 generates event. “Operand” parameter defines when to generate event: On Exit, On Entrance, On Both, On Hysteresis and On Delta Change.

Event only - when selected NO, I/O element status value will be appeared in each AVL record, and when selected YES, I/O element status value will be appended only to eventual records.

Operand – defines when event is send:

5.22.1 Operand On Exit

Record is generated when actual value input increases and becomes higher or lower than high or low level.

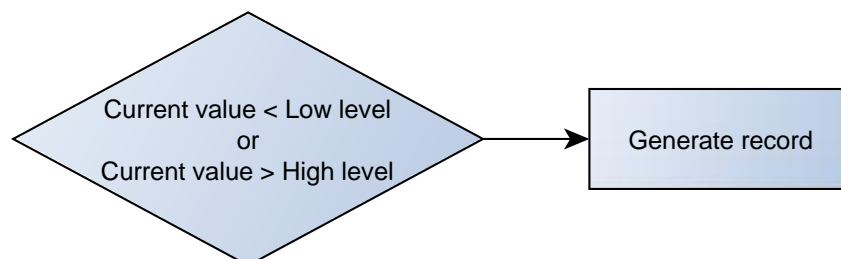

Figure 42 On Exit operand logic

5.22.2 Operand On Entrance

Record is generated when actual value input is between high and low level values.

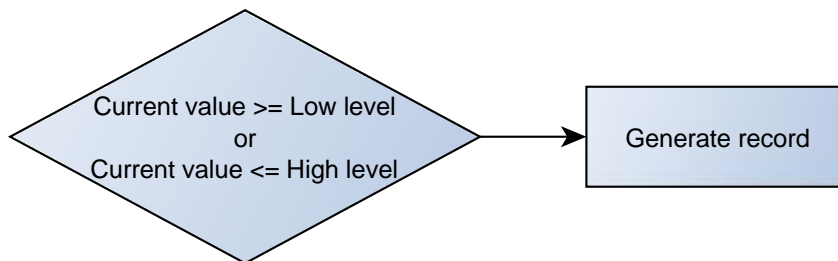

Figure 43 On Entrance operand logic

5.22.3 Operand On Both

Record is generated when actual value input increases or decreases and becomes higher or lower than high or low level values.

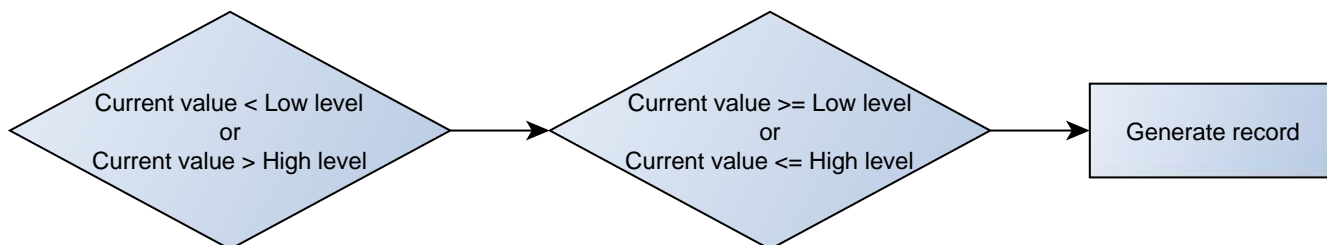

Figure 44 On Both operand logic

5.22.4 Operand Monitoring

No event at all. Values are recorded only when other trigger have worked.

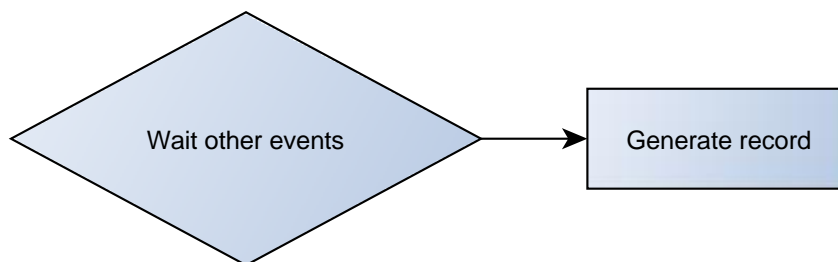

Figure 45 Monitoring operand logic

5.22.5 Operand On Hysteresis

Record is generated when actual value input becomes higher than high level value and decreasing becomes less than low level value.

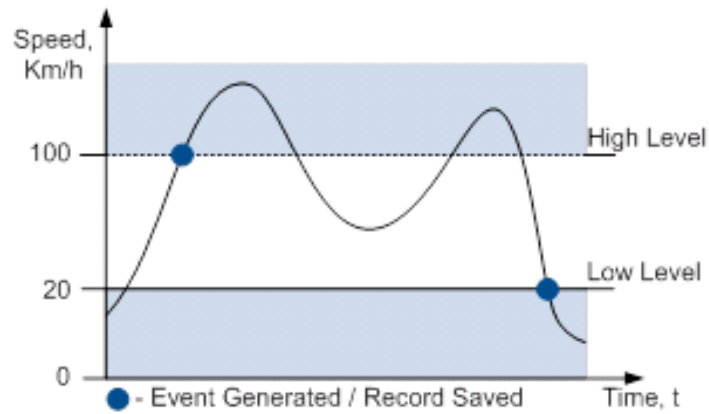

Figure 46 Hysteresis operand logic

5.22.6 Operand On Change

Record is generated when value changes.

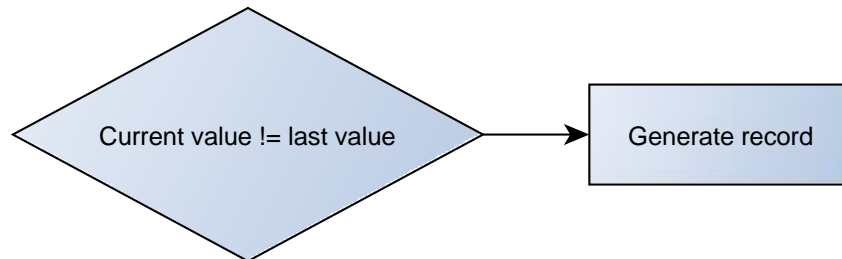

Figure 47 On change operand logic

5.22.7 Operand On Delta Change

Record is generated when value changes and absolute value of last value minus actual input value becomes equal or higher than high level value.

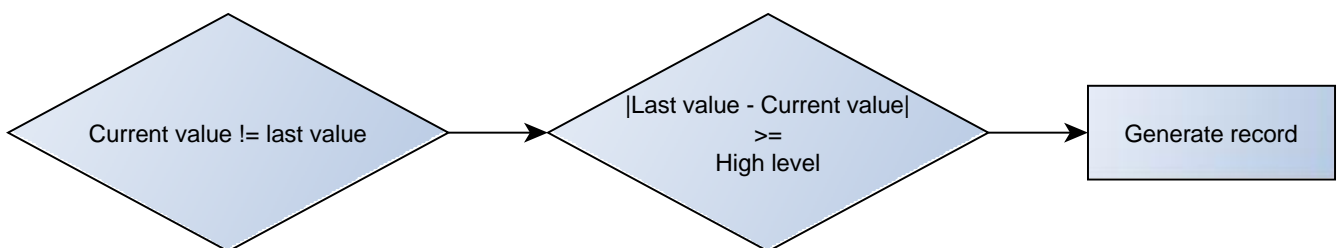

Figure 48 On Delta Change operand logic

5.22.8 Avg const (Averaging parameter description)

If avg const value is 10, new value must be present for 1 second to register change to new value. Internally sampling is done every 40ms, so 25 samples are taken in second. To configure 5 seconds averaging multiply 10 by 5 yielding 50. The same logic works even if device is in deep sleep mode.

Averaging follows RC exponential curves, see image bellow:

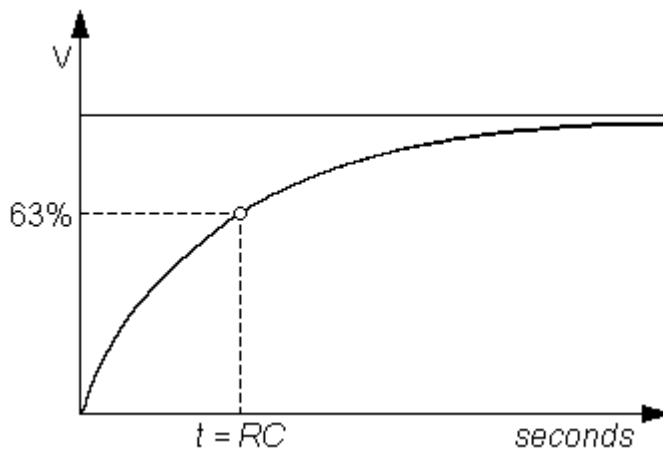

Figure 49 Averaging counting explanation

For Boolean values 5τ , values is used, that means value change is taken when new values is averaged to more then 99.3%.

5.23 All I/O elements description

5.23.1 Permaement I/O elements

| Permanent I/O elements (are always sent to server if enabled) | | |
|--|------------------|---|
| Nr. | Property Name | Description |
| 1 | Ignition | Logic: 0 / 1 |
| 2 | Movement | Logic: 0 / 1 |
| 3 | Data mode | 0 – home on stop, 1 – home on move, 2 – roaming on stop, 3 – roaming on move, 4 – unknown on stop, 5 – unknown on move |
| 4 | GSM signal | GSM signal level value in scale 1 – 5 |
| 5 | Deep sleep | Logic: 0 / 1 |
| 6 | GNSS power | States: 0 – short circ., 1 – connected. Parameter defines if GPS antenna is short circuit. All the time value will be sent 1. The only condition to get value 0, then antenna is damaged and short circuit. |
| 7 | GNSS PDOP | Probability * 10; 0-500 |
| 8 | GNSS HDOP | Probability * 10; 0-500 |
| 9 | External Voltage | Voltage: mV, 0 – 30 V |
| 10 | Speed | Value in km/h, 0 – xxx km/h |
| 11 | GSM Cell ID | GSM base station ID |
| 12 | GSM Area Code | Location Area code (LAC), it depends on GSM operator. It provides unique number which assigned to a set of base GSM stations. Max value: 65536 |
| 13 | Battery Voltage | Shows battery Voltage in mV |
| 14 | Battery Current | Shows battery Current in mA |

| | | |
|----|---------------------|--|
| 15 | Active GSM operator | Currently used GSM Operator code |
| 16 | Trip odometer | Distance between two records: m |
| 17 | Total odometer | Total odometer count: m |
| 18 | Cell ID | GSM base station ID |
| 19 | Digital Input 1 | Logic: 0 / 1 |
| 20 | Analog Input 1 | Voltage: mV, 0 – 30 V |
| 21 | Digital output 1 | Logic: 0 / 1 |
| 22 | Fuel Used GPS | Fuel used (ml) by GPS |
| 23 | Fuel Rate GPS | Fuel Consumption by average speed (l/100km) |
| 24 | Axis X | Accelerometer axis x value |
| 25 | Axis Y | Accelerometer axis y value |
| 26 | Axis Z | Accelerometer axis z value |
| 26 | ICCID | Integrated Circuit Card Identifier |
| 27 | SD Status | 0 – SD card not inserted 1 – SD card inserted |
| 28 | Eco Score | Eco driving score during particular trip, 0 - 10 |

6 SMS COMMAND LIST

All commands are case sensitive. While FMB920 operates in Deep Sleep mode and user tries to send SMS message it cannot arrive to FMB920 device, because GSM/GPRS module is disabled most of the time (wake up depends on Send Period parameter). FMB920 will receive the SMS when it wakes up (exits deep sleep mode).

While FMB920 is in GPS Sleep or Online Deep Sleep mode and user tries to send SMS message it will arrive to device, because GSM module is enabled.

6.1 SMS command list

Table 4 SMS commands

| Command | Description | Response |
|-------------------|---|----------|
| getinfo | Device runtime system information | Yes |
| getver | Returns code version, device IMEI, modem app version, RTC time, Init time, Uptime and BT MAC address. | Yes |
| getstatus | Modem Status information | Yes |
| getgps | Current GPS data, date and time. | Yes |
| getio | Readout analog input,digital input and output | Yes |
| ggps | Returns location information with Google maps link | Yes |
| readio # | Returns IO status, # AVL ID | Yes |
| cpureset | Resets device | No |
| getparam # | Returns selected parameter value, # param ID | Yes |
| setparam #:# | Sets selected parameter value. 1.# - ID value. 2.# - New Parameter Value | Yes |
| flush #,#,#,#,#,# | Redirects device to other server. 1.# - IMEI 2.# - APN | Yes |

| | | |
|--------------------|--|-----|
| | 3.# - LOGIN 4.# - PASS 5.# - IP 6.# - PORT 7.# - MODE (0-TCP/1-UDP) | |
| countrecs | Returns records number | Yes |
| deleterecords | Delete all records from SD card | Yes |
| setdigout # # | Set digital output 1.# – 0 or 1 (0 - OFF or 1 – ON) 2.# – timeout value if needed (in seconds) | Yes |
| battery | Returns battery state info. | Yes |
| wdlog | Returns all information about “watch dogs” restarts. | Yes |
| fc_reset | Resets fuel consumption parameters | Yes |
| towingreact | Towing reactivation | Yes |
| auto_calibrate:set | Calibrate position if car accelerate straight to > 30 km/h for 5 sec. | Yes |
| auto_calibrate:get | returns the state of calibration | Yes |
| odoset:# | Set total odometer value. # - new odometer value in km | Yes |
| odoget | Display current odometer value | Yes |
| btgetlist # | Returns requested Bluetooth list. # - 0,1 or 2 (0 – Discovered, 1 – Paired, 2 – Connected) | Yes |
| btscan | Starts Bluetooth scan. | Yes |
| btvisible # | Sets Bluetooth to visible with TMO. # - visibility TMO (from 1 to 255 seconds). | Yes |
| btrelease # | Disconnects from current device and pauses auto connect functionality for TMO # - none or TMO (from 1 to 255 seconds). | Yes |
| btunpair # | Unpair Bluetooth device. # - all, BT address (all – unpair all devices, BT address – unpair only specified MAC address). | Yes |
| defaultcfg | Load default configuration. | Yes |
| obdinfo | If connected with Bluetooth OBD dongle displays all available information from OBD. | Yes |
| faultcodes | If connected with Bluetooth OBD dongle display all visible fault codes. | Yes |
| setkey # # | Add new or change current configuration keyword. If device is locked, keyword cannot be changed 1.# - old keyword (if adding new keyword space (view chapter 5.1.2)) 2.# - new keyword | Yes |
| delkey # | Remove existing keyword. (If device is locked, keyword cannot be changed) # - old keyword | Yes |
| bbread # | Return black box information (HEX value of event ID and HEX value of custom data field (optional)). | Yes |

| | | |
|----------|--|-----|
| | 1.# - returns entered number of latest events. When # is omitted the latest events are packed to single SMS. | |
| bbinfo # | Return same information as bbread command but additional all events timestamp is written in HEX. 1.# - returns entered number of latest events. When # is omitted the latest events are packed to single SMS. | Yes |
| sdformat | Format SD card. | Yes |

Setparam, setkey, delkey and setdigout SMS is used to configure device.

Parameter ID consists of 3 or 5 digits. Detailed list of parameters and IDs can be found in chapter number "System parameters"

Example: **'username password setparam 102:0'** will disable sleep mode.

Example: **'username password setparam 2001:wap;2002:user;2003:pass'** will change configured APN name, APN username and APN password. SMS command of limited to 160 characters.

Example: **'username password setdigout 1 60'** will set digital output ON for 60s.

6.1.1 getinfo

| Response details | Description |
|------------------|---|
| RTC | RTC Time |
| Init | Device initialization time |
| UpTime | Total up time (in seconds) |
| PWR | Last restart reason: "Unknown" – unknown reasons, "PwrVoltage" – device is started after connect voltage supply, "SoftReset" – device expected restart, ie. Cpureset or after FOTA success process, "SwWatchdog" – Modem FW issue, something is wrong with modem FW, "HwWatchdog - Teltonika FW issue, something is wrong with firmware", "Abnormal" - fatal. |
| RST | Total restarts count |
| GPS | GPS receiver state. 0 – OFF, 1 – ON without fix, 2 – ON with fix, 3 – In sleep mode. |
| SAT | Average satellites |
| TTF | Time To First Fix |
| TTLF | Time To Last Fix |
| NOGPS | How much time no GPS fix (h:min) |
| SR | Number of Sent Records |
| FG | Failed GPRS counter |
| FL | Failed link counter |
| SMS | Sent SMS Counter |
| REC | Records Found – number of records in the memory. |
| MD | Data Mode state. 0 – Home and Stop, 1 – Home and Moving, 2 – Roaming and Stop, 3 – Roaming and Moving, 4 – Unknown and Stop, 5 – Unknown |

| | |
|--|------------|
| | and Moving |
|--|------------|

Example: "RTC:2017/6/16 7:13 Init:2017/6/16 5:44 UpTime:4744s PWR:PwrVoltage RST:0 GPS:1 SAT:0 TTF:0 TTL:0 NOGPS: 1:18 SR:0 FG:200 FL:0 SMS:3 REC:42 MD:1".

6.1.2 getver

| Response details | Description |
|------------------|----------------------------|
| Ver | Firmware version |
| GPS | Version of GPS module |
| Hw | Version of hardware |
| Mod | HW version modification |
| IMEI | Device IMEI |
| Init | Device initialization time |
| Uptime | Total up time (in seconds) |
| BT | Device MAC address |

Example: "Ver:02.00.01_06 GPS:AXN_3.80_3333_16070400,0000,, Hw:FMB920 Mod:4 IMEI:352094082042885 Init: 2017-6-16 5:54 Uptime: 16574 BT:31F5BFE66261".

6.1.3 getstatus

| Response details | Description |
|------------------|--|
| Data Link | Indicate module connection to server at the moment: 0 – Not connected, 1 – connected |
| GPRS | Indicate if GPRS is available at the moment |
| Phone | Voice Call status: 0 – ready, 1 – unavailable, 2 – unknown, 3 –ringing, 4 – call in progress, 5 – asleep |
| SIM | SIM Status: 0-ready, 1-pin, 2-puk, 3-pin2, 4-puk2 |
| OP | Connected to GSM Operator: numerical id of operator |
| Signal | GSM Signal Quality [0-5] |
| NewSMS | Indicate if new message received |
| Roaming | 0 – Home Network, 1 – roaming |
| SMSFull | SMS storage is full? 0 – ok, 1 – SMS storage full |
| LAC | GSM Tower Location Area Code |
| Cell ID | GSM Tower Cell ID Code |

Example: "Data Link: 0 GPRS: 1 Phone: 0 SIM: 0 OP: 24602 Signal: 5 NewSMS: 0 Roaming: 0 SMSFull: 0 LAC: 1 Cell ID: 3055".

6.1.4 getgps

| Response details | Description |
|------------------|---|
| GPS | Indicates valid (1) or invalid (0) Gps data |
| Sat | Count of currently available satellites |
| Lat | Latitude (Last good Latitude) |
| Long | Longitude (Last good Longitude) |
| Alt | Altitude |
| Speed | Ground speed, km/h |
| Dir | Ground direction, degrees |
| Date | Current date |

| | |
|------|------------------|
| Time | Current GMT time |
|------|------------------|

Example: "GPS:1 Sat:0 Lat:54.666042 Long:25.225031 Alt:0 Speed:0 Dir:0 Date: 2017/6/16 Time: 12:52:30".

6.1.5 getio

| Response details | Description |
|------------------|------------------------|
| DIN1 | Digital input 1 value |
| AIN1 | Analog input 1 value |
| DO1 | Digital output 1 value |

Example: "DI1:0 AIN1:0 DO1:0".

6.1.6 ggps

| Response details | Description |
|------------------|--|
| D | Date |
| T | Time |
| S | Actual Speed |
| C | Latitude (Last good Latitude), Longitude (Last good Longitude) |
| Url | Google Maps Link |

Example (if no GNSS FIX): "GPS Data not Available. No GPS signal".

Example: D:17/1/9 T:12:52:30 S:0.00 C:54.666042, 25.225032 Url: <http://maps.google.com/?q=54.666042,25.225032&om=1speed:0>

6.1.7 readio

| Response details | Description |
|------------------|-------------------|
| ID | I/O element ID |
| Value | I/O Element value |

Example (if wrong ID): "Not supported or not enabled IO element requested".

Example: "Param ID:239 Value:0".

6.1.8 getparam

Read parameter value. ID consists of 3 or 5 digits. A detailed list of parameters and identifiers can be found in this chapter next later.

Example: ,getparam 2001' command will request APN name

Answer: Param ID:2001 Value:wap

6.1.9 setparam

Read parameter value. ID consists of 3 or 5 digits. A detailed list of parameters and identifiers can be found in this chapter next later.

Example: ,setparam 2001:wap' will change configured APN name

Answer: Param ID:2001 Value:wap2

Example: 'setparam 2001:wap;2002:user;2003:pass' will change configured APN name, APN username and APN password. SMS command of limited to 160 characters.

6.1.10 flush #,#,#,#,#,#

Initiates all data sending by GPRS to specified target server. Comma separated parameters

go as numbered:

- 1.# - IMEI
- 2.# - APN
- 3.# - GPRS LOGIN
- 4.# - GPRS PASSWORD
- 5.# - IP
- 6.# - PORT
- 7.# - MODE (0-TCP/1-UDP)

Parameters are separated by comma (no spaces needed). In case you don't need to enter parameter (APN Login/ APN Pass) – do not put space, simply put comma and write next parameter.

Example: opa opa flush 353976012555151,banga,,,212.47.99.62,12050,0

| Response details | Description |
|----------------------------|--|
| FLUSH SMS Accepted | FLUSH SMS Accepted |
| # records found on FLASH | Number of records found on FLASH |
| Minimum Records to Send: # | Number of minimum saved records to send |
| GPRS Enabled: # | State of the GPRS connection, 0 – disabled; 1 – enabled |
| Time Sync: # | Indicates time synchronization on the device, 0 – not synchronized; 1 – synchronized |

Example: "FLUSH SMS Accepted. 11 records found on FLASH. Minimum Records to Send: 1. GPRS Enabled: 1. Time Sync: 1."

6.1.11 countrecs

Returns currently records number in SD card or device memory.

Example (if more that 100): "more then 100 records found".

Example: "25 records found".

6.1.12 deleterecords

Delete all records from SD card or device memory.

6.1.13 setdigout

Sets digital output to ON or OFF state (timeout for output is controllable)

Example: 'setdigout 1 60' will set OUT to high level for 60 seconds,

'setdigout 1' will set OUT to high level for infinite time.

6.1.14 battery

| Response details | Description |
|------------------|---|
| BatState | Battery connected (1) or disconnected (0) from device |
| FSMState | Current battery state |
| ChargerIC | Battery charging status |
| ExtV | External Voltage |
| BatV | Battery voltage |

| | |
|------|--------------------------|
| Batl | Battery charging current |
|------|--------------------------|

Example: "BatState: 1 FSMState: ACTIVE ChargerIC: OFF ExtV: 11796 BatV: 3942 BatI: 0".

6.1.15 fc_reset

Reset GPS fuel consumption value.

Example: "Fuel Consumption parameters reseted".

6.1.16 towingreact

Reactivates Towing Detection to initial state (does not wait for ignition to be OFF). Useful when generated false Towing event and needs reactivation.

6.1.17 odoset:#

Set new total odometer value in km.

Example: "Saved Odometer Value: 5000 km".

6.1.18 odoget

Get total odometer value in km.

Example: "Current Odometer Value:5000 km".

6.1.19 btgetlist

btgetlist command needs argument what list should be printed!

btgetlist 0; device will respond with BT_LIST_Discovered

btgetlist 1; device will respond with all paired devices

btgetlist 2; device will respond with connected bluetooth device



Note: Without argument it is always 0 i.e **BT_LIST_Discovered**
In FW 01.00.23 btgetlist (without args) will not respond (as unknown command).

6.1.20 obdinfo

| Response details | Description |
|------------------|---|
| LIST of OBD info | Protocol, VIN, AdaptiveTiming value, requested PID counter, OBD application state, available vehicle PIDs, mil status, number of DTCs |

Example:

"Prot:0,VIN:N/A,TM:10,CNT:0,ST:OFF,P1:0x0,P2:0x0,P3:0x0,P4:0x0,MIL:0,DTC:0,IDO,Hdr:0,Phy:0".

6.1.21 faultcodes

| Response details | Description |
|------------------|-------------|
|------------------|-------------|

| | |
|------|--|
| LIST | Returns list of fault codes; response when no faults: "No fault codes detected." |
|------|--|

Example: "P0100,P0200,P0300,C0300,B0200,U0100".

6.1.22 setkey #

"setkey <oldkeyword> <newkeyword>" - Set new or change the keyword. Configuration should be not locked.

Example: New keyword (set):

<name>{space}<pass>{space}setkey{space}{space}<newkeyword>

Change keyword (change):

<name>{space}<pass>{space}setkey{space}<oldkeyword>{space}<newkeyword>

6.1.23 delkey #

"delkey <keyword>" - Deletes current keyword. Configuration keyword should be configured and not locked.

Example:

<name>{space}<pass>{space}delkey{space}<keyword>

6.1.24 bbread

describes start offset and is an optional field. # of value 20 means that blackbox data is requested starting from 20th latest event. When # is omitted the latest events are packet to single SMS.

Example: X1:Y1,X2:Y2,...,Xn:Yn, where Xn – HEX value of event ID. Yn – HEX value of custom data field (optional).

6.1.25 bbinfo

describes start offset and is an optional field. # of value 20 means that blackbox data is requested starting from 20th latest event. When # is omitted the latest events are packet to single SMS.

Example: X1-Y1:Z1,X2-Y2:Z2,...,Xn-Yn:Zn, where Xn – timestamp in HEX. Yn – HEX value of event ID. Zn – HEX value of custom data field (optional).

6.1.26 sdformat

Format sd card (deleta all information from SD card).

7 PARAMETER LIST

7.1 System parameters

7.1.1 Sleep Mode (ID=102)

Device has three sleep modes: GPS sleep, Deep Sleep and Online Deep Sleep mode. While sleep is disabled (value 0) module will never enter sleep mode, in sleep mode (value 1) module reduces level of power usage by turning GPS module to sleep, in deep sleep mode (value 2) module turns GPS module to sleep and device is deregistered from network (note, that FMB920 do not receive SMS while in deep sleep), online Deep Sleep mode (value 3) device works as in Deep Sleep mode, but without deregistering from GSM network, Ultra Deep Sleep mode (value

4) where GPS and GSM modem are turned off and device functions are suspended for maximum battery saving. **NOTE!** Only DIN1 and movement, detected by accelerometer, will bring device out of Ultra Deep Sleep. Movement source and Ignition source configuration is not taken into account in this case. GSM part stays powered, so this increases power consumption. In this mode, device should received/send SMS and make/receive calls. Also not closes GPRS context, if previously opened.

| Minimum value | Maximum value | Default value | Goes with (depends on) parameters | Value type |
|---------------|---------------|---------------|-----------------------------------|------------|
| 0 | 4 | 2 | Sleep timeout (ID=103) | Uint8 |

7.1.2 Sleep timeout (ID=103)

Sleep timeout is time after which FMB920 goes to GPS sleep, Deep Sleep or Online Deep Sleep if other requirements are met. It is measured in minutes.

| Minimum value | Maximum value | Default value | Goes with (depends on) parameters | Value type |
|---------------|---------------|---------------|-----------------------------------|------------|
| 1 | 3000 | 10 | Sleep Mode (ID=102) | Uint8 |

7.1.3 Movement Source (ID=100)

Device can operate and change its working mode according to motion detection source: ignition (value 0), movement sensor (value 1), GPS (value 2), CAN speed (value 3).

| Minimum value | Maximum value | Default value | Goes with (depends on) parameters | Value type |
|---------------|---------------|---------------|-----------------------------------|------------|
| 0 | 3 | 1 | - | Uint8 |

7.1.4 Static Navigation (ID=106)

When static navigation is enabled, FMB920 filters out GPS jumps, when it is not moving. When it is disabled, it does not make any changes to collected GPS data.

| Minimum value | Maximum value | Default value | Goes with (depends on) parameters | Value type |
|---------------|---------------|---------------|-------------------------------------|------------|
| 0 | 1 | 1 | Static Navigation Settings (ID=112) | Uint8 |

7.1.5 Static Navigation Settings (ID=112)

Sets static navigation exit (movement) detection sources. Movement Source (value 1), Ignition Source (value 2).

| Minimum value | Maximum value | Default value | Goes with (depends on) parameters | Value type |
|---------------|---------------|---------------|--|------------|
| 1 | 2 | 1 | Static Navigation (ID=106) Movement Source (ID=100) Ignition settings (ID=101) | Uint8 |

7.1.6 Saving/Sending without time synchronization (ID=107)

When this feature is enabled (value = 1), then records can be saved and sent to server without time synchronization.

| Minimum value | Maximum value | Default value | Goes with (depends on) parameters | Value type |
|---------------|---------------|---------------|-----------------------------------|------------|
| 0 | 1 | 1 | | Uint8 |

7.1.7 GNSS Source (ID=109)

This parameter sets Satellite System, available values:

| | |
|--|----------|
| Undefined | value:0 |
| Beidou only | value:1 |
| Glonass only | value:2 |
| Galileo only | value:4 |
| Galileo+Beidou | value:5 |
| Galileo+Glonass | value:6 |
| GPS only | value:8 |
| GPS+Beidou | value:9 |
| GPS+Glonass | value:10 |
| GPS+Galileo | value:12 |
| GPS+Galileo+Beidou | value:13 |
| GPS+Galileo+Glonass | value:14 |
| GPS, Galileo, Glonass and Beidou and not allowed | value:15 |

| Minimum value | Maximum value | Default value | Goes with (depends on) parameters | Value type |
|---------------|---------------|---------------|-----------------------------------|------------|
| 0 | 15 | 10 | | Uint8 |

7.1.8 Ignition settings (ID=101)

This parameter sets ignition source available values:

- 1 – Digital Input
- 2– Accelerometer
- 3 – Digital Input or Accelerometer
- 4 – Power voltage
- 5 – Digital Input or Power Voltage
- 6 – Accelerometer or Power Voltage
- 7 – Digital Input, Accelerometer or Power voltage
- 8 – Engine RPM
- 9 – Digital Input or Engine RPM
- 10 – Accelerometer or Engine RPM
- 11 – Digital Input, Accelerometer or Engine RPM

12 – Power voltage or Engine RPM

13 – Digital Input, Power Voltage or Engine RPM

14 – Accelerometer, Power Voltage or Engine RPM

15 – Digital Input, Accelerometer, Power voltage or Engine RPM

| Minimum value | Maximum value | Default value | Goes with (depends on) parameters | Value type |
|---------------|---------------|---------------|--|------------|
| 1 | 15 | 4 | High voltage level (ID=104) Low voltage level (ID=105) Movement Start Delay(s) (ID=19001) Movement Stop Delay(s) (ID=19002) | Uint8 |

7.1.9 High voltage level (ID=104)

Sets high level of voltage.

| Minimum value | Maximum value | Default value | Goes with (depends on) parameters | Value type |
|----------------------------------|---------------|---------------|--|------------|
| 0 (but higher than low level) | 30000 | 30000 | Ignition settings (ID=101) Low voltage level (ID=105) | Uint16 |

7.1.10 Low voltage level (ID=105)

Sets low level of voltage.

| Minimum value | Maximum value | Default value | Goes with (depends on) parameters | Value type |
|---------------|--------------------------------------|---------------|---|------------|
| 0 | 29999 (but lower than high level) | 13200 | Ignition settings (ID=101) High voltage level (ID=104) | Uint16 |

7.1.11 Movement Start Delay(s) (ID=19001)

What Accelerometer Ignition source delay will be after Ignition on.

| Minimum value | Maximum value | Default value | Goes with (depends on) parameters | Value type |
|---------------|---------------|---------------|---|------------|
| 1 | 60 | 1 | Ignition settings (ID=101) Movement Stop Delay(s) (ID=19002) | Uint8 |

7.1.12 Movement Stop Delay(s) (ID=19002)

What Accelerometer Ignition source delay will be after Ignition off.

| Minimum value | Maximum value | Default value | Goes with (depends on) parameters | Value type |
|---------------|---------------|---------------|---|------------|
| 5 | 60 | 60 | Ignition settings (ID=101) Movement Start Delay(s) (ID=19001) | Uint16 |

7.1.13 Led indication (ID=108)

Sets led indication: 0 – disabled, 1 – enabled

| Minimum value | Maximum value | Default value | Goes with (depends on) parameters | Value type |
|---------------|---------------|---------------|-----------------------------------|------------|
| 0 | 1 | 1 | | Uint8 |

7.1.14 Synchronization settings (ID=900)

Settings used for device internal time synchronization: 0 – GPS only, 1 – NITZ and NTP, 2 – NTP, 3 – NITZ.

| Minimum value | Maximum value | Default value | Goes with (depends on) parameters | Value type |
|---------------|---------------|---------------|---|------------|
| 0 | 3 | 1 | NTP Resync (ID=901) NTP server 1 (ID=902) NTP server 2 (ID=903) | Uint8 |

7.1.15 NTP Resync (ID=901)

Periodical time synchronization. If not zero FMBxxx will resynchronize time once set period expires.

| Minimum value | Maximum value | Default value | Goes with (depends on) parameters | Value type |
|---------------|---------------|---------------|--|------------|
| 0 | 24 | 0 | Synchronization settings (ID=900) NTP server 1 (ID=902) NTP server 2 (ID=903) | Uint8 |

7.1.16 NTP server 1 (ID=902)

| Minimum value | Maximum value | Default value | Goes with (depends on) parameters | Value type |
|---------------|----------------|-------------------|--|------------|
| 0 | 55 char string | avl1.teltonika.lt | Synchronization settings (ID=900) NTP Resync (ID=901) NTP server 2 (ID=903) | S8[55] |

7.1.17 NTP server 2 (ID=903)

| Minimum value | Maximum value | Default value | Goes with (depends on) parameters | Value type |
|---------------|----------------|---------------|--------------------------------------|------------|
| 0 | 55 char string | pool.ntp.org | Synchronization settings (ID=900) | S8[55] |

| | | | | |
|--|--|--|--|--|
| | | | NTP Resync (ID=901) NTP server 1 (ID=902) | |
|--|--|--|--|--|

7.1.18 Battery charge mode (ID=110)

Sets when charging is allowed: 0 – On Need, 1 – After Ignition ON.

| Minimum value | Maximum value | Default value | Goes with (depends on) parameters | Value type |
|---------------|---------------|---------------|-----------------------------------|------------|
| 0 | 1 | 0 | | Uint8 |

7.2 Records parameters

7.2.1 Sorting (ID=1002)

Record sorting parameter is responsible for record sorting order. Value of 0 arranging data starting from newest, while value of 1 arranging data starting from oldest.

| Minimum value | Maximum value | Default value | Goes with (depends on) parameters | Value type |
|---------------|---------------|---------------|--|------------|
| 0 | 1 | 0 | Open Link Timeout (ID=1000) Server Response Timeout (ID=1001) | Uint8 |

7.2.2 Open Link Timeout (ID=1000)

Defines for how many seconds device will keep connection to the server after successful data transfer while waiting for a new record.

| Minimum value | Maximum value | Default value | Goes with (depends on) parameters | Value type |
|---------------|---------------|---------------|--|------------|
| 30 | 259200 | 30 | Sorting (ID=1002) Server Response Timeout (ID=1001) | Uint32 |

7.2.3 Server Response Timeout (ID=1001)

Defines time period (in seconds) for server response to sent records.

| Minimum value | Maximum value | Default value | Goes with (depends on) parameters | Value type |
|---------------|---------------|---------------|--|------------|
| 5 | 300 | 30 | Sorting (ID=1002) Open Link Timeout (ID=1000) | Uint16 |



ATTENTION! Some GSM operators may disconnect the device from an active data link if the device doesn't send any data for a very long time, even if active data link timeout is set to maximum value. The amount of time that an operator keeps the link open depends solely on the operator. For example, if active data link timeout is set to maximum, 259200 seconds (72 hours), and the device

sends data to server every 86400 seconds (24 hours), the operator might disconnect the link earlier and the device will have to connect to the server anew. This may cost extra, depending on the operator GPRS data charge. It is strongly recommended, when using active data link timeout, that data sending to the server should not be very rare (24 hours or more). If data sending is more frequent, then the operator will not disconnect the device from the server.

7.3 GPRS parameters

7.3.1 GPRS content activation (ID=2000)

Parameter allows or does not allow GPRS usage. If GPRS is not allowed value is 0, if GPRS is allowed value is 1.

| Minimum value | Maximum value | Default value | Goes with (depends on) parameters | Value type |
|---------------|---------------|---------------|--|------------|
| 0 | 1 | 1 | APN Name (ID=2001) APN username (ID=2002) APN Password (ID=2003) | Uint8 |

7.3.2 APN Name (ID=2001)

Parameter defines GPRS Access Point Name.

| Minimum value | Maximum value | Default value | Goes with (depends on) parameters | Value type |
|---------------|----------------|---------------|---|------------|
| 0 | 32 char string | Empty | GPRS content activation (ID=2000) APN username (ID=2002) APN Password (ID=2003) | S8[32] |

7.3.3 APN username (ID=2002)

Parameter defines APN username. In case operator does not use username for login, value should be empty.

| Minimum value | Maximum value | Default value | Goes with (depends on) parameters | Value type |
|---------------|----------------|---------------|---|------------|
| 0 | 30 char string | Empty | GPRS content activation (ID=2000) APN Name (ID=2001) APN Password (ID=2003) | S8[30] |

7.3.4 APN Password (ID=2003)

Parameter defines APN password. In case operator does not use password for login, value should be empty.

| Minimum value | Maximum value | Default value | Goes with (depends on) parameters | Value type |
|---------------|---------------|---------------|-----------------------------------|------------|
| 0 | 30 char | Empty | GPRS content activation | S8[30] |

| | | | | |
|--|--------|--|---|--|
| | string | | (ID=2000) APN Name (ID=2001) APN username (ID=2002) | |
|--|--------|--|---|--|

7.3.5 Domain (ID=2004)

Parameter defines AVL data destination server IP address. Example: 212.47.99.62

| Minimum value | Maximum value | Default value | Goes with (depends on) parameters | Value type |
|---------------|----------------|---------------|-----------------------------------|------------|
| 0 | 55 char string | Empty | GPRS content activation (ID=2000) | S8[55] |

7.3.6 Target Server Port (ID=2005)

Parameter defines AVL data destination server port number. Example: 12050

| Minimum value | Maximum value | Default value | Goes with (depends on) parameters | Value type |
|---------------|---------------|---------------|-----------------------------------|------------|
| 0 | 65535 | 0 | GPRS content activation (ID=2000) | Uint16 |

7.3.7 Protocol (ID=2006)

Parameter defines GPRS data transport protocol. Module can use TCP or UDP transport protocol to send data to server. For TCP protocol value is 0, for UDP protocol value is 1.

| Minimum value | Maximum value | Default value | Goes with (depends on) parameters | Value type |
|---------------|---------------|---------------|-----------------------------------|------------|
| 0 | 1 | 0 | GPRS content activation (ID=2000) | Uint8 |

7.3.8 Backup Server Domain (ID=2007)

Parameter defines AVL data destination backup server IP address. Example: 212.47.99.61

| Minimum value | Maximum value | Default value | Goes with (depends on) parameters | Value type |
|---------------|----------------|---------------|---|------------|
| 0 | 55 char string | Empty | GPRS content activation (ID=2000) Backup Server Mode (ID=2010) | S8[55] |

7.3.9 Backup Server Port (ID=2008)

Parameter defines AVL data destination backup server port number. Example: 12051

| Minimum value | Maximum value | Default value | Goes with (depends on) parameters | Value type |
|---------------|---------------|---------------|-----------------------------------|------------|
| 0 | 65535 | 0 | GPRS content activation (ID=2000) | Uint16 |

| | | | | |
|--|--|--|------------------------------|--|
| | | | Backup Server Mode (ID=2010) | |
|--|--|--|------------------------------|--|

7.3.10 Backup Server Protocol (ID=2009)

Parameter defines GPRS data transport protocol. Module can use TCP or UDP transport protocol to send data to backup server. For TCP protocol value is 0, for UDP protocol value is 1.

| Minimum value | Maximum value | Default value | Goes with (depends on) parameters | Value type |
|---------------|---------------|---------------|---|------------|
| 0 | 1 | 0 | GPRS content activation (ID=2000) Backup Server Mode (ID=2010) | Uint8 |

7.3.11 Backup Server Mode (ID=2010)

Sets backup server mode: 0 – Disable (backup server not used), 1 – Backup (sent to backup server if main server not available), 2 – Duplicate (send records to both servers).

| Minimum value | Maximum value | Default value | Goes with (depends on) parameters | Value type |
|---------------|---------------|---------------|-----------------------------------|------------|
| 0 | 2 | 0 | GPRS content activation (ID=2000) | Uint8 |

7.3.12 GPRS Authentication parameters (ID=2016)

Sets GPRS Authentication mode: 0 – Normal (PAP), 1 – Secured (CHAP).

| Minimum value | Maximum value | Default value | Goes with (depends on) parameters | Value type |
|---------------|---------------|---------------|-----------------------------------|------------|
| 0 | 1 | 0 | GPRS content activation (ID=2000) | Uint8 |

7.4 SMS/Call settings

7.4.1 SMS data sending settings (ID=3000)

Parameter allows or does not allow sending AVL data using binary SMS. If SMS use is not allowed value is 0 and 1 if SMS use is allowed.

| Minimum value | Maximum value | Default value | Goes with (depends on) parameters | Value type |
|---------------|---------------|---------------|-----------------------------------|------------|
| 0 | 1 | 0 | Data send number (ID=3001) | Uint8 |

7.4.2 Data send number (ID=3001)

In this field are written GSM numbers, to which will be sent Data SMS.

| Minimum value | Maximum value | Default value | Goes with (depends on) parameters | Value type |
|---------------|---------------|---------------|-----------------------------------|------------|
| | | | | |

| | | | | |
|-------|-----------|---|-------------------------------------|--------|
| Empty | 16 digits | - | SMS data sending settings (ID=3000) | S8[16] |
|-------|-----------|---|-------------------------------------|--------|

7.4.3 Authorized phone numbers (ID=4000-4009)

If at least one number is entered then only those number can send messages to device.

Example: +37060012346

| Minimum value | Maximum value | Default value | Goes with (depends on) parameters | Value type |
|---------------|---------------|---------------|--|------------|
| Empty | 16 digits | - | SMS Login (ID=3003) SMS Password (ID=3004) Digital Output control (ID=12000) | S8[16] |

7.4.4 GSM Predefined Numbers (ID=6000-6009)

In this field GSM numbers are written, to which will be sent "Event SMS" text message.

Example: +37060012346

| Minimum value | Maximum value | Default value | Goes with (depends on) parameters | Value type |
|---------------|---------------|---------------|---|------------|
| Empty | 16 digits | - | GSM number index (ID=3008) Green driving Send SMS to (ID=7034) Over Speeding Send SMS To (ID=7032) Trip Send SMS To (ID=7031) AutoGeofence Send SMS to (ID=7030) Send sms to #1-5 Geozone (ID=7025-7029), #6-50 Geozone (ID=7071-7115) Unplug send sms to (ID=7067) Towing Make Call(Sms Event Number ID) (ID=11604) Towing Send SMS (ID=7066) Crash sms send to (ID= 7037) Excessive idling Send SMS To (ID=7033) I/O#1 send SMS (ID=7000) OBD II (Bluetooth) property parameters Send SMS to (ID=7038-7037) | S8[16] |

7.4.5 SMS Login (ID=3003)

User login is used to ensure module security. Used in every SMS that is sent to device.

Example: ba321

| Minimum value | Maximum value | Default value | Goes with (depends on) parameters | Value type |
|---------------|---------------|---------------|-----------------------------------|------------|
| | | | | |

| | | | | |
|-------|--------|---|---|-------|
| Empty | 5 char | - | SMS Password (ID=3004) SMS Event Time Zone (ID=3006) | S8[5] |
|-------|--------|---|---|-------|

7.4.6 SMS Password (ID=3004)

User password is used to ensure module security. Used in every SMS that is sent to device.
Example: ab123

| Minimum value | Maximum value | Default value | Goes with (depends on) parameters | Value type |
|---------------|---------------|---------------|--|------------|
| Empty | 5 char | - | SMS Login (ID=3003) SMS Event Time Zone (ID=3006) | S8[5] |

7.4.7 Incoming call action (ID=3005)

Parameter defines action during call: 0 – do nothing, 1 – hang up, 2 – report position, 3 – Not used, 4 –Auto Answer (HF).

| Minimum value | Maximum value | Default value | Goes with (depends on) parameters | Value type |
|---------------|---------------|---------------|-----------------------------------|------------|
| 0 | 4 | 0 | | Uint8 |

7.4.8 SMS Event Time Zone (ID=3006)

Time zone which will be used in eventual SMS messages.

| Minimum value | Maximum value | Default value | Goes with (depends on) parameters | Value type |
|---------------|---------------|---------------|---|------------|
| -720 | 840 | 0 | SMS Password (ID=3004) SMS Login (ID=3003) | Uint16 |

7.4.9 Hands Free Call Settings (ID=3007)

Parameter defines hands free call trigger: 0 – Disable, 1 – DIN1, 2 – Crash event, 3 – DIN1 and Crash event.

| Minimum value | Maximum value | Default value | Goes with (depends on) parameters | Value type |
|---------------|---------------|---------------|-----------------------------------|------------|
| 0 | 3 | 0 | GSM number index (ID=3008) | Uint16 |

7.4.10 GSM number index (ID=3008)

Define to what number will be called after configured call trigger is activated. 0 – Disable, 1-10 – call to configured GSM Predefined Number.

| Minimum value | Maximum value | Default value | Goes with (depends on) parameters | Value type |
|---------------|---------------|---------------|---|------------|
| 0 | 10 | 0 | Hands Free Call Settings (ID=3007) GSM Predefined Numbers (ID=6000-6009) | Uint8 |

7.4.11 Roaming Operator List (ID=5000-5049)

Parameter defines roaming operator list. According to this list module selects operating profile. If roaming operator list is left empty, FMB920 will automatically detect home operator. If home operator will be written to roaming operator list any part, it will be detected as home operator, not roaming. All other written operators are Preferred Roaming Operator Codes.

| Minimum value | Maximum value | Default value | Goes with (depends on) parameters | Value type |
|---------------|---------------|---------------|-----------------------------------|------------|
| 0 | 999999 | 0 | | Uint32 |

7.4.12 Black List (ID=5500-5549)

Operator Blacklist - if user wants that FMB920 do not connect and work with a particular operator it must be written to Operator BlackList. All functionality described 5.8 chapter (GSM Operators, Roaming Operator list, Blacklist Operator list).

| Minimum value | Maximum value | Default value | Goes with (depends on) parameters | Value type |
|---------------|---------------|---------------|-----------------------------------|------------|
| 0 | 999999 | 0 | | Uint32 |

7.5 Data Acquisition Modes parameters

7.5.1 Home Network GSM operator code "Vehicle on STOP" parameters

7.5.1.1 Min Period (ID=10000)

This parameter indicates time interval in seconds in order to acquire new record. If value is 0 it means no records by min period will be saved.

| Minimum value | Maximum value | Default value | Goes with (depends on) parameters | Value type |
|---------------|---------------|---------------|--|------------|
| 0 | 2592000 | 3600 | Min Saved Records (ID=10004) Send Period (ID=10005) | Uint32 |

7.5.1.2 Min Saved Records (ID=10004)

This parameter defines minimum number of records in one data packet that can be sent to server. It has higher priority than Data Send Period (ID=10005).

| Minimum value | Maximum value | Default value | Goes with (depends on) parameters | Value type |
|---------------|---------------|---------------|---|------------|
| 1 | 255 | 1 | Min Period (ID=10000) Send Period (ID=10005) | Uint8 |

7.5.1.3 Send Period (ID=10005)

This parameter indicates frequency (time interval in seconds) of sending data to server.

| Minimum value | Maximum value | Default value | Goes with (depends on) parameters | Value type |
|---------------|---------------|---------------|-----------------------------------|------------|
| 0 | 2592000 | 120 | Min Period (ID=10000) | Uint32 |

| | | | | |
|--|--|--|---------------------------------|--|
| | | | Min Saved Records (ID=10004) | |
|--|--|--|---------------------------------|--|

7.5.2 Home Network GSM operator code “Vehicle MOVING” parameters

7.5.2.1 Min Period (ID=10050)

This parameter indicates time interval in seconds in order to acquire new record. If value is 0 it means no records by min period will be saved.

| Minimum value | Maximum value | Default value | Goes with (depends on) parameters | Value type |
|---------------|---------------|---------------|---|------------|
| 0 | 2592000 | 300 | Min Distance (ID=10051) Min Angle (ID=10052) Min Speed Delta (ID=10053) Min Saved Records (ID=10054) Send Period (ID=10055) | Uint32 |

7.5.2.2 Min Distance (ID=10051)

This parameter indicates distance in meters in order to acquire new record. Record is stored when the distance between previous records is greater than parameters value. If value is 0 it means no records by min distance will be saved.

| Minimum value | Maximum value | Default value | Goes with (depends on) parameters | Value type |
|---------------|---------------|---------------|---|------------|
| 0 | 65535 | 100 | Min Period (ID=10050) Min Angle (ID=10052) Min Speed Delta (ID=10053) Min Saved Records (ID=10054) Send Period (ID=10055) | Uint16 |

7.5.2.3 Min Angle (ID=10052)

This parameter indicates angle in degrees in order to acquire new record. If angle difference between last recorded coordinate and current position is greater than defined value, new record is stored. This parameter is operational, when speed is higher than 10km/h. If value is 0 it means no records by min angle will be saved.

| Minimum value | Maximum value | Default value | Goes with (depends on) parameters | Value type |
|---------------|---------------|---------------|--|------------|
| 0 | 180 | 10 | Min Period (ID=10050) Min Distance (ID=10051) Min Speed Delta (ID=10053) Min Saved Records (ID=10054) Send Period (ID=10055) | Uint8 |

7.5.2.4 Min Speed Delta (ID=10053)

This parameter indicates speed difference in order to acquire new record. If speed difference between last recorded coordinate and current position is greater than defined value, new record is stored. If value is 0 it means no records by min speed delta will be saved.

| Minimum value | Maximum value | Default value | Goes with (depends on) parameters | Value type |
|---------------|---------------|---------------|--|------------|
| 0 | 255 | 10 | Min Period (ID=10050) Min Distance (ID=10051) Min Angle (ID=10052) Min Saved Records (ID=10054) Send Period (ID=10055) | Uint8 |

7.5.2.5 Min Saved Records (ID=10054)

This parameter defines minimum number of records in one data packet that can be sent to server. It has higher priority than Data Send Period (ID=10055).

| Minimum value | Maximum value | Default value | Goes with (depends on) parameters | Value type |
|---------------|---------------|---------------|--|------------|
| 1 | 255 | 1 | Min Period (ID=10050) Min Distance (ID=10051) Min Angle (ID=10052) Min Speed Delta (ID=10053) Send Period (ID=10055) | Uint8 |

7.5.2.6 Send Period (ID=10055)

This parameter indicates frequency (time interval in seconds) of sending data to server.

| Minimum value | Maximum value | Default value | Goes with (depends on) parameters | Value type |
|---------------|---------------|---------------|--|------------|
| 0 | 2592000 | 120 | Min Period (ID=10050) Min Distance (ID=10051) Min Angle (ID=10052) Min Speed Delta (ID=10053) Min Saved Records (ID=10054) | Uint32 |

7.5.3 Roaming Network GSM operator code "Vehicle on STOP" parameters

7.5.3.1 Min Period (ID=10100)

This parameter indicates time interval in seconds in order to acquire new record. If value is 0 it means no records by min period will be saved.

| Minimum | Maximum | Default value | Goes with (depends on) | Value |
|---------|---------|---------------|------------------------|-------|
|---------|---------|---------------|------------------------|-------|

| value | value | | parameters | type |
|-------|---------|------|--|--------|
| 0 | 2592000 | 3600 | Min Saved Records (ID=10104) Send Period (ID=10105) | Uint32 |

7.5.3.2 Min Saved Records (ID=10104)

This parameter defines minimum number of records in one data packet that can be sent to server. It has higher priority than Data Send Period (ID=10105).

| Minimum value | Maximum value | Default value | Goes with (depends on) parameters | Value type |
|---------------|---------------|---------------|---|------------|
| 1 | 255 | 1 | Min Period (ID=10100) Send Period (ID=10105) | Uint8 |

7.5.3.3 Send Period (ID=10105)

This parameter indicates frequency (time interval in seconds) of sending data to server.

| Minimum value | Maximum value | Default value | Goes with (depends on) parameters | Value type |
|---------------|---------------|---------------|---|------------|
| 0 | 2592000 | 120 | Min Period (ID=10100) Min Saved Records (ID=10104) | Uint32 |

7.5.4 Roaming Network GSM operator code "Vehicle MOVING" parameters

7.5.4.1 Min Period (ID=10150)

This parameter indicates time interval in seconds in order to acquire new record. If value is 0 it means no records by min period will be saved.

| Minimum value | Maximum value | Default value | Goes with (depends on) parameters | Value type |
|---------------|---------------|---------------|---|------------|
| 0 | 2592000 | 300 | Min Distance (ID=10151) Min Angle (ID=10152) Min Speed Delta (ID=10153) Min Saved Records (ID=10154) Send Period (ID=10155) | Uint32 |

7.5.4.2 Min Distance (ID=10151)

This parameter indicates distance in meters in order to acquire new record. Record is stored when the distance between previous records is greater than parameter's value. If value is 0 it means no records by min distance will be saved.

| Minimum value | Maximum value | Default value | Goes with (depends on) parameters | Value type |
|---------------|---------------|---------------|---|------------|
| 0 | 65535 | 100 | Min Period (ID=10150) Min Angle (ID=10152) Min Speed Delta (ID=10153) Min Saved Records (ID=10154) | Uint16 |

| | | | | |
|--|--|--|------------------------|--|
| | | | Send Period (ID=10155) | |
|--|--|--|------------------------|--|

7.5.4.3 Min Angle (ID=10152)

This parameter indicates angle in degrees in order to acquire new record. If angle difference between last recorded coordinate and current position is greater than defined value, new record is stored. This parameter is operational, when speed is higher than 10km/h. If value is 0 it means no records by min angle will be saved.

| Minimum value | Maximum value | Default value | Goes with (depends on) parameters | Value type |
|---------------|---------------|---------------|--|------------|
| 0 | 180 | 10 | Min Period (ID=10150) Min Distance (ID=10151) Min Speed Delta (ID=10153) Min Saved Records (ID=10154) Send Period (ID=10155) | Uint8 |

7.5.4.4 Min Speed Delta (ID=10153)

This parameter indicates speed difference in order to acquire new record. If speed difference between last recorded coordinate and current position is greater than defined value, new record is stored. If value is 0 it means no records by min speed delta will be saved.

| Minimum value | Maximum value | Default value | Goes with (depends on) parameters | Value type |
|---------------|---------------|---------------|--|------------|
| 0 | 255 | 10 | Min Period (ID=10150) Min Distance (ID=10151) Min Angle (ID=10152) Min Saved Records (ID=10154) Send Period (ID=10155) | Uint8 |

7.5.4.5 Min Saved Records (ID=10154)

This parameter defines minimum number of records in one data packet that can be sent to server. It has higher priority than Data Send Period (ID=10105).

| Minimum value | Maximum value | Default value | Goes with (depends on) parameters | Value type |
|---------------|---------------|---------------|--|------------|
| 1 | 255 | 1 | Min Period (ID=10150) Min Distance (ID=10151) Min Angle (ID=10152) Min Speed Delta (ID=10153) Send Period (ID=10155) | Uint8 |

7.5.4.6 Send Period (ID=10155)

This parameter indicates frequency (time interval in seconds) of sending data to server.

| Minimum value | Maximum value | Default value | Goes with (depends on) parameters | Value type |
|---------------|---------------|---------------|-----------------------------------|------------|
| | | | | |

| | | | | |
|---|---------|-----|--|--------|
| 0 | 2592000 | 120 | Min Period (ID=10150) Min Distance (ID=10151) Min Angle (ID=10152) Min Speed Delta (ID=10153) Min Saved Records (ID=10154) | Uint32 |
|---|---------|-----|--|--------|

7.5.5 Unknown Network GSM operator code “Vehicle on STOP” parameters

7.5.5.1 Min Period (ID=10200)

This parameter indicates time interval in seconds in order to acquire new record. If value is 0 it means no records by min period will be saved.

| Minimum value | Maximum value | Default value | Goes with (depends on) parameters | Value type |
|---------------|---------------|---------------|--|------------|
| 0 | 2592000 | 3600 | Min Saved Records (ID=10204) Send Period (ID=10205) | Uint32 |

7.5.5.2 Min Saved Records (ID=10204)

This parameter defines minimum number of records in one data packet that can be sent to server. It has higher priority than Data Send Period (ID=10205).

| Minimum value | Maximum value | Default value | Goes with (depends on) parameters | Value type |
|---------------|---------------|---------------|---|------------|
| 1 | 255 | 1 | Min Period (ID=10200) Send Period (ID=10205) | Uint8 |

7.5.5.3 Send Period (ID=10205)

This parameter indicates frequency (time interval in seconds) of sending data to server.

| Minimum value | Maximum value | Default value | Goes with (depends on) parameters | Value type |
|---------------|---------------|---------------|---|------------|
| 0 | 2592000 | 120 | Min Period (ID=10200) Min Saved Records (ID=10204) | Uint32 |

7.5.6 Unknown Network GSM operator code “Vehicle MOVING” parameters

7.5.6.1 Min Period (ID=10250)

This parameter indicates time interval in seconds in order to acquire new record. If value is 0 it means no records by min period will be saved.

| Minimum value | Maximum value | Default value | Goes with (depends on) parameters | Value type |
|---------------|---------------|---------------|---|------------|
| 0 | 2592000 | 300 | Min Distance (ID=10251) Min Angle (ID=10252) Min Speed (ID=10253) | Uint32 |

| | | | | |
|--|--|--|---|--|
| | | | Min Saved Records (ID=10254) Send Period (ID=10255) | |
|--|--|--|---|--|

7.5.6.2 Min Distance (ID=10251)

This parameter indicates distance in meters in order to acquire new record. Record is stored when the distance between previous records is greater than parameter's value. If value is 0 it means no records by min distance will be saved.

| Minimum value | Maximum value | Default value | Goes with (depends on) parameters | Value type |
|---------------|---------------|---------------|---|------------|
| 0 | 65535 | 100 | Min Period (ID=10250) Min Angle (ID=10252) Min Speed (ID=10253) Min Saved Records (ID=10254) Send Period (ID=10255) | Uint16 |

7.5.6.3 Min Angle (ID=10252)

This parameter indicates angle in degrees in order to acquire new record. If angle difference between last recorded coordinate and current position is greater than defined value, new record is stored. This parameter is operational, when speed is higher than 10km/h. If value is 0 it means no records by min angle will be saved.

| Minimum value | Maximum value | Default value | Goes with (depends on) parameters | Value type |
|---------------|---------------|---------------|--|------------|
| 0 | 180 | 10 | Min Period (ID=10250) Min Distance (ID=10251) Min Speed (ID=10253) Min Saved Records (ID=10254) Send Period (ID=10255) | Uint8 |

7.5.6.4 Min Speed (ID=10253)

This parameter indicates speed difference in order to acquire new record. If speed difference between last recorded coordinate and current position is greater than defined value, new record is stored. If value is 0 it means no records by min speed delta will be saved.

| Minimum value | Maximum value | Default value | Goes with (depends on) parameters | Value type |
|---------------|---------------|---------------|--|------------|
| 0 | 255 | 10 | Min Period (ID=10250) Min Distance (ID=10251) Min Angle (ID=10252) Min Saved Records (ID=10254) Send Period (ID=10255) | Uint8 |

7.5.6.5 Min Saved Records (ID=10254)

This parameter defines minimum number of records in one data packet that can be sent to server. It has higher priority than Data Send Period (ID=10105).

| Minimum value | Maximum value | Default value | Goes with (depends on) parameters | Value type |
|---------------|---------------|---------------|--|------------|
| 1 | 255 | 1 | Min Period (ID=10250) Min Distance (ID=10251) Min Angle (ID=10252) Min Speed (ID=10253) Send Period (ID=10255) | Uint8 |

7.5.6.6 Send Period (ID=10255)

This parameter indicates frequency (time interval in seconds) of sending data to server.

| Minimum value | Maximum value | Default value | Goes with (depends on) parameters | Value type |
|---------------|---------------|---------------|--|------------|
| 0 | 2592000 | 120 | Min Period (ID=10250) Min Distance (ID=10251) Min Angle (ID=10252) Min Speed (ID=10253) Min Saved Records (ID=10254) | Uint32 |

7.6 Features Parameters

7.6.1 Green driving parameters

7.6.1.1 Green driving priority (ID=11000)

Defines priority of green driving scenario: 0 – disabled, 1 – low, 2 – high, 3 – panic.

| Minimum value | Maximum value | Default value | Goes with (depends on) parameters | Value type |
|---------------|---------------|---------------|---|------------|
| 0 | 3 | 0 | Max Acceleration Force (ID=11004) Max Braking Force (ID=11005) Max Cornering (ID=11006) Green/Eco driving (ID=11007) Green driving digital output control settings (ID=11003) Green driving Digital output on duration (ID=11001) Green driving Digital output off duration (ID=11002) Green driving Send SMS to (ID=7034) Green driving SMS text (ID=8034) | Uint8 |

7.6.1.2 Max Acceleration Force (ID=11004)

It is max allowed acceleration force which can be reached while accelerating without triggering harsh acceleration event (m/s²).

| Minimum value | Maximum value | Default value | Goes with (depends on) parameters | Value type |
|---------------|---------------|---------------|---|------------|
| 0.5 | 10 | 2.2 | Green driving priority (ID=11000) Max Braking Force (ID=11005) Max Cornering (ID=11006) Green/Eco driving (ID=11007) Green driving digital output control settings (ID=11003) Green driving Digital output on duration (ID=11001) Green driving Digital output off duration (ID=11002) Green driving Send SMS to (ID=7034) Green driving SMS text (ID=8034) | Uint8 |

7.6.1.3 Max Braking Force (ID=11005)

It is max allowed braking force which can be reached while braking without triggering harsh braking event (m/s^2).

| Minimum value | Maximum value | Default value | Goes with (depends on) parameters | Value type |
|---------------|---------------|---------------|--|------------|
| 0.5 | 10 | 2.5 | Green driving priority (ID=11000) Max Acceleration Force (ID=11004) Max Cornering (ID=11006) Green/Eco driving (ID=11007) Green driving digital output control settings (ID=11003) Green driving Digital output on duration (ID=11001) Green driving Digital output off duration (ID=11002) Green driving Send SMS to (ID=7034) Green driving SMS text (ID=8034) | Uint8 |

7.6.1.4 Max Cornering (ID=11006)

It is max allowed cornering angle which can be reached while cornering without triggering harsh cornering event (m/s^2).

| Minimum value | Maximum value | Default value | Goes with (depends on) parameters | Value type |
|---------------|---------------|---------------|-----------------------------------|------------|
|---------------|---------------|---------------|-----------------------------------|------------|

| | | | | |
|-----|----|-----|--|-------|
| 0.5 | 10 | 2.1 | Green driving priority (ID=11000) Max Acceleration Force (ID=11004) Max Braking Force (ID=11005) Green/Eco driving (ID=11007) Green driving digital output control settings (ID=11003) Green driving Digital output on duration (ID=11001) Green driving Digital output off duration (ID=11002) Green driving Send SMS to (ID=7034) Green driving SMS text (ID=8034) | Uint8 |
|-----|----|-----|--|-------|

7.6.1.5 Green/Eco driving (ID=11007)

Choose between Eco driving(accelerometer) and Green driving(gps). 0 – GPS, 1 – Accelerometer

| Minimum value | Maximum value | Default value | Goes with (depends on) parameters | Value type |
|---------------|---------------|---------------|--|------------|
| 0 | 1 | 0 | Green driving priority (ID=11000) Max Acceleration Force (ID=11004) Max Braking Force (ID=11005) Max Cornering (ID=11006) Green driving digital output control settings (ID=11003) Green driving Digital output on duration (ID=11001) Green driving Digital output off duration (ID=11002) Green driving Send SMS to (ID=7034) Green driving SMS text (ID=8034) | Uint8 |

7.6.1.6 Green Driving Duration (ID=11008)

If enabled, additional record with Green/Eco Driving event duration (ms) will be saved and send to server. 0 – Disable, 1 – Enable

| Minimum value | Maximum value | Default value | Goes with (depends on) parameters | Value type |
|---------------|---------------|---------------|-----------------------------------|------------|
| 0 | 1 | 0 | Green driving priority (ID=11000) | Uint8 |

| | | | | |
|--|--|--|---|--|
| | | | Max Acceleration Force (ID=11004) Max Braking Force (ID=11005) Max Cornering (ID=11006) Green/Eco driving (ID=11007) Green driving digital output control settings (ID=11003) Green driving Digital output on duration (ID=11001) Green driving Digital output off duration (ID=11002) Green driving Send SMS to (ID=7034) Green driving SMS text (ID=8034) | |
|--|--|--|---|--|

7.6.1.7 Green driving digital output control settings (ID=11003)
Sets digital output off (0) or on (1)

| Minimum value | Maximum value | Default value | Goes with (depends on) parameters | Value type |
|---------------|---------------|---------------|--|------------|
| 0 | 1 | 0 | Green driving priority (ID=11000) Max Acceleration Force (ID=11004) Max Braking Force (ID=11005) Max Cornering (ID=11006) Green/Eco driving (ID=11007) Green driving Digital output on duration (ID=11001) Green driving Digital output off duration (ID=11002) Green driving Send SMS to (ID=7034) Green driving SMS text (ID=8034) | Uint8 |

7.6.1.8 Green driving Digital output on duration (ID=11001)
Output ON duration in mili-seconds

| Minimum value | Maximum value | Default value | Goes with (depends on) parameters | Value type |
|---------------|---------------|---------------|--|------------|
| 100 | 5000 | 200 | Green driving priority (ID=11000) Max Acceleration Force (ID=11004) Max Braking Force (ID=11005) | Uint32 |

| | | | | |
|--|--|--|---|--|
| | | | Max Cornering (ID=11006) Green/Eco driving (ID=11007) Green driving digital output control settings (ID=11003) Green driving Digital output off duration (ID=11002) Green driving Send SMS to (ID=7034) Green driving SMS text (ID=8034) | |
|--|--|--|---|--|

7.6.1.9 Green driving Digital output off duration (ID=11002)
 Output OFF duration in in mili-seconds

| Minimum value | Maximum value | Default value | Goes with (depends on) parameters | Value type |
|---------------|---------------|---------------|--|------------|
| 0 | 5000 | 200 | Green driving priority (ID=11000) Max Acceleration Force (ID=11004) Max Braking Force (ID=11005) Max Cornering (ID=11006) Green/Eco driving (ID=11007) Green driving digital output control settings (ID=11003) Green driving Digital output on duration (ID=11001) Green driving Send SMS to (ID=7034) Green driving SMS text (ID=8034) | Uint32 |

7.6.1.10 Green driving Send SMS to (ID=7034)

Enable/disable sms event sending. 0 – Disable, 1-10 – sms will be sent to configured GSM number.

| Minimum value | Maximum value | Default value | Goes with (depends on) parameters | Value type |
|---------------|---------------|---------------|--|------------|
| 0 | 10 | 0 | Green driving priority (ID=11000) Max Acceleration Force (ID=11004) Max Braking Force (ID=11005) Max Cornering (ID=11006) Green/Eco driving (ID=11007) Green driving digital output | Uint8 |

| | | | | |
|--|--|--|---|--|
| | | | control settings (ID=11003) Green driving Digital output on duration (ID=11001) Green driving Digital output off duration (ID=11002) Green driving SMS text (ID=8034) GSM Predefined Numbers (ID=6000-6009) | |
|--|--|--|---|--|

7.6.1.11 Green driving SMS text (ID=8034)

Configure green driving sms event text here.

| Minimum value | Maximum value | Default value | Goes with (depends on) parameters | Value type |
|---------------|---------------|---------------|--|------------|
| 0 | 160 char | Green Driving | Green driving priority (ID=11000) Max Acceleration Force (ID=11004) Max Braking Force (ID=11005) Max Cornering (ID=11006) Green/Eco driving (ID=11007) Green driving digital output control settings (ID=11003) Green driving Digital output on duration (ID=11001) Green driving Digital output off duration (ID=11002) Green driving Send SMS to (ID=7034) | S8[160] |

7.6.2 Overspeeding scenario parameters

7.6.2.1 Overspeeding priority (ID=11100)

Defines priority of overspeeding scenario: 0 – disabled, 1 – low, 2 – high, 3 – panic.

| Minimum value | Maximum value | Default value | Goes with (depends on) parameters | Value type |
|---------------|---------------|---------------|--|------------|
| 0 | 3 | 0 | Max allowed Speed (ID=11104) Overspeeding output control (ID=11103) Overspeeding Digital output on duration (ID=11101) Overspeeding Digital output off duration (ID=11102) Over Speeding Send SMS To | Uint8 |

| | | | | |
|--|--|--|--|--|
| | | | (ID=7032) Over Speeding SMS Text (ID=8032) | |
|--|--|--|--|--|

7.6.2.2 Max allowed Speed (ID=11104)

It is max allowed speed which can be reached. If this value exceeded Over speeding event will occur.

| Minimum value | Maximum value | Default value | Goes with (depends on) parameters | Value type |
|---------------|---------------|---------------|--|------------|
| 0 | 260 | 90 | Overspeeding priority (ID=11100) Overspeeding output control (ID=11103) Overspeeding Digital output on duration (ID=11101) Overspeeding Digital output off duration (ID=11102) Over Speeding Send SMS To (ID=7032) Over Speeding SMS Text (ID=8032) | Uint16 |

7.6.2.3 Overspeeding output control (ID=11103)

Enables (1) or disables (0) overspeeding output control

| Minimum value | Maximum value | Default value | Goes with (depends on) parameters | Value type |
|---------------|---------------|---------------|--|------------|
| 0 | 1 | 0 | Overspeeding priority (ID=11100) Max allowed Speed (ID=11104) Overspeeding Digital output on duration (ID=11101) Overspeeding Digital output off duration (ID=11102) Over Speeding Send SMS To (ID=7032) Over Speeding SMS Text (ID=8032) | Uint8 |

7.6.2.4 Overspeeding Digital output on duration (ID=11101)

Output ON duration in mili-seconds

| Minimum value | Maximum value | Default value | Goes with (depends on) parameters | Value type |
|---------------|---------------|---------------|---|------------|
| 100 | 5000 | 200 | Overspeeding priority (ID=11100) Max allowed Speed (ID=11104) Overspeeding output control | Int32 |

| | | | | |
|--|--|--|--|--|
| | | | (ID=11103) Overspeeding Digital output off duration (ID=11102) Over Speeding Send SMS To (ID=7032) Over Speeding SMS Text (ID=8032) | |
|--|--|--|--|--|

7.6.2.5 Overspeeding Digital output off duration (ID=11102)
Output OFF duration in mili-seconds

| Minimum value | Maximum value | Default value | Goes with (depends on) parameters | Value type |
|---------------|---------------|---------------|---|------------|
| 0 | 5000 | 200 | Overspeeding priority (ID=11100) Max allowed Speed (ID=11104) Overspeeding output control (ID=11103) Overspeeding Digital output on duration (ID=11101) Over Speeding Send SMS To (ID=7032) Over Speeding SMS Text (ID=8032) | Int32 |

7.6.2.6 Overspeeding Send SMS To (ID=7032)

Enable/disable sms event sending. 0 – Disable, 1-10 – sms will be sent to configured GSM number.

| Minimum value | Maximum value | Default value | Goes with (depends on) parameters | Value type |
|---------------|---------------|---------------|--|------------|
| 0 | 10 | 0 | Overspeeding priority (ID=11100) Max allowed Speed (ID=11104) Overspeeding output control (ID=11103) Overspeeding Digital output on duration (ID=11101) Overspeeding Digital output off duration (ID=11102) Over Speeding SMS Text (ID=8032) GSM Predefined Numbers (ID=6000-6009) | UInt8 |

7.6.2.7 Overspeeding SMS Text (ID=8032)

Configure over speeding sms event text here.

| Minimum value | Maximum value | Default value | Goes with (depends on) parameters | Value type |
|---------------|---------------|---------------|--|------------|
| 0 | 160 char | Overspeeding | Overspeeding priority (ID=11100) Max allowed Speed (ID=11104) Overspeeding output control (ID=11103) Overspeeding Digital output on duration (ID=11101) Overspeeding Digital output off duration (ID=11102) Over Speeding Send SMS To (ID=7032) | S8[160] |

7.6.3 Jamming scenario parameters

7.6.3.1 Jamming priority (ID=11300)

Scenario settings: 0 – Disable, 1 – Low, 2 – High, 3 – Panic

| Minimum value | Maximum value | Default value | Goes with (depends on) parameters | Value type |
|---------------|---------------|---------------|--|------------|
| 0 | 3 | 0 | Jamming Eventual records (ID=11303) Jamming Output Control (ID=11304) Time Until Jamming Event Detection (ID=11305) Jamming DOUT on duration [ms] (ID=11301) Jamming DOUT off duration [ms] (ID=11302) | Uint8 |

7.6.3.2 Jamming Eventual records (ID=11303)

Disables or enables eventual records. 0 – Disable, 1 – Enable

| Minimum value | Maximum value | Default value | Goes with (depends on) parameters | Value type |
|---------------|---------------|---------------|--|------------|
| 0 | 1 | 1 | Jamming priority (ID=11300) Jamming Output Control (ID=11304) Time Until Jamming Event Detection (ID=11305) Jamming DOUT on duration [ms] (ID=11301) Jamming DOUT off duration | Uint8 |

| | | | | |
|--|--|--|-----------------|--|
| | | | [ms] (ID=11302) | |
|--|--|--|-----------------|--|

7.6.3.3 Jamming Output Control (ID=11304)

Defines rather jamming will control digital output or not. 0 – Disable, 1 – Enable.

| Minimum value | Maximum value | Default value | Goes with (depends on) parameters | Value type |
|---------------|---------------|---------------|---|------------|
| 0 | 1 | 0 | Jamming priority (ID=11300) Jamming Eventual records (ID=11303) Time Until Jamming Event Detection(ID=11305) Jamming DOUT on duration [ms] (ID=11301) Jamming DOUT off duration [ms] (ID=11302) | UInt8 |

7.6.3.4 Time Until Jamming Event Detection(ID=11305)

After Jamming trigger count TMO (in seconds), control OUTPUT and generate event after this timeout. If Jamming End trigger is detected during counting no event will be generated and output will not be controlled.

| Minimum value | Maximum value | Default value | Goes with (depends on) parameters | Value type |
|---------------|---------------|---------------|--|------------|
| 0 | 65535 | 60 | Jamming priority (ID=11300) Jamming Eventual records (ID=11303) Jamming Output Control (ID=11304) Jamming DOUT on duration [ms] (ID=11301) Jamming DOUT off duration [ms] (ID=11302) | UInt16 |

7.6.3.5 Jamming DOUT on duration [ms] (ID=11301)

Sets time period, that Dout will be on.

| Minimum value | Maximum value | Default value | Goes with (depends on) parameters | Value type |
|---------------|---------------|---------------|--|------------|
| 100 | 5000 | 200 | Jamming priority (ID=11300) Jamming Eventual records (ID=11303) Jamming Output Control (ID=11304) Time Until Jamming Event Detection(ID=11305) Jamming DOUT off duration [ms] (ID=11302) | Int32 |

7.6.3.6 Jamming DOUT off duration [ms] (ID=11302)

Sets time period, that Dout will be off.

| Minimum value | Maximum value | Default value | Goes with (depends on) parameters | Value type |
|---------------|---------------|---------------|--|------------|
| 0 | 5000 | 200 | Jamming priority (ID=11300) Jamming Eventual records (ID=11303) Jamming Output Control (ID=11304) Time Until Jamming Event Detection (ID=11305) Jamming DOUT on duration [ms] (ID=11301) | Int32 |

7.6.4 Trip scenario parameters

7.6.4.1 Trip priority (ID=11800)

Defines priority of trip scenario:

0 – disabled, 1 – low, 2 – high, 3 – panic

| Minimum value | Maximum value | Default value | Goes with (depends on) parameters | Value type |
|---------------|---------------|---------------|---|------------|
| 0 | 3 | 0 | Eventually Records (ID=11801) Trip mode (ID=11802) Start Speed (ID=11803) Ignition Off Timeout (ID=11804) Eco Score allowed events (ID=700) Trip Send SMS To (ID=7031) Trip SMS Text (ID=8031) Odometer distance calculation source (ID=11806) | Uint8 |

7.6.4.2 Eventually Records (ID=11801)

Disables or enables eventual records. 0 – Disable, 1 – Enable.

| Minimum value | Maximum value | Default value | Goes with (depends on) parameters | Value type |
|---------------|---------------|---------------|---|------------|
| 0 | 1 | 0 | Trip priority (ID=11800) Trip mode (ID=11802) Start Speed (ID=11803) Ignition Off Timeout (ID=11804) Eco Score allowed events (ID=700) Trip Send SMS To (ID=7031) Trip SMS Text (ID=8031) | Uint8 |

| | | | | |
|--|--|--|---|--|
| | | | Odometer distance calculation source (ID=11806) | |
|--|--|--|---|--|

7.6.4.3 Trip mode (ID=11802)

For this feature I/O ODOMETER must be enabled. If I/O ODOMETER is enabled, and mode is set to Continuous (value 0), TRIP distance is going to be counted till the end of trip, if between records mode is set (value 1), ODOMETER will count distance only between two records.

| Minimum value | Maximum value | Default value | Goes with (depends on) parameters | Value type |
|---------------|---------------|---------------|---|------------|
| 0 | 1 | 0 | Trip priority (ID=11800) Eventually Records (ID=11801) Start Speed (ID=11803) Ignition Off Timeout (ID=11804) Eco Score allowed events (ID=700) Trip Send SMS To (ID=7031) Trip SMS Text (ID=8031) Odometer distance calculation source (ID=11806) | Uint8 |

7.6.4.4 Start Speed (ID=11803)

This parameter represents speed (km/h), which is detected as minimum speed to indicate TRIP START and generate event.

| Minimum value | Maximum value | Default value | Goes with (depends on) parameters | Value type |
|---------------|---------------|---------------|---|------------|
| 0 | 255 | 5 | Trip priority (ID=11800) Eventually Records (ID=11801) Trip mode (ID=11802) Ignition Off Timeout (ID=11804) Eco Score allowed events (ID=700) Trip Send SMS To (ID=7031) Trip SMS Text (ID=8031) Odometer distance calculation source (ID=11806) | Uint8 |

7.6.4.5 Ignition Off Timeout (ID=11804)

This parameter represents timeout to wait if ignition (ignition source) is off in order to detect TRIP STOP and generate event.

| Minimum value | Maximum value | Default value | Goes with (depends on) parameters | Value type |
|---------------|---------------|---------------|---|------------|
| 0 | 65535 | 60 | Trip priority (ID=11800) Eventually Records (ID=11801) Trip mode (ID=11802) Start Speed (ID=11803) | Uint16 |

| | | | | |
|--|--|--|---|--|
| | | | Eco Score allowed events (ID=700) Trip Send SMS To (ID=7031) Trip SMS Text (ID=8031) Odometer distance calculation source (ID=11806) | |
|--|--|--|---|--|

7.6.4.6 Eco Score allowed events (ID=700)

How much Eco score events are allowed to generate in 100 km trip distance, that ECO score result would be excellent (10).

| Minimum value | Maximum value | Default value | Goes with (depends on) parameters | Value type |
|---------------|---------------|---------------|--|------------|
| 0 | 65535 | 10 | Trip priority (ID=11800) Eventually Records (ID=11801) Trip mode (ID=11802) Start Speed (ID=11803) Ignition Off Timeout (ID=11804) Trip Send SMS To (ID=7031) Trip SMS Text (ID=8031) Odometer distance calculation source (ID=11806) | UInt16 |

7.6.4.7 Trip Send SMS To (ID=7031)

Enable/disable sms event sending. 0 – Disable, 1-10 – sms will be sent to configured GSM number.

| Minimum value | Maximum value | Default value | Goes with (depends on) parameters | Value type |
|---------------|---------------|---------------|--|------------|
| 0 | 10 | 0 | Trip priority (ID=11800) Eventually Records (ID=11801) Trip mode (ID=11802) Start Speed (ID=11803) Ignition Off Timeout (ID=11804) Eco Score allowed events (ID=700) Trip SMS Text (ID=8031) Odometer distance calculation source (ID=11806) GSM Predefined Numbers (ID=6000-6009) | UInt8 |

7.6.4.8 Trip SMS Text (ID=8031)

Configure trip sms event text here.

| Minimum value | Maximum value | Default value | Goes with (depends on) parameters | Value type |
|---------------|---------------|---------------|---|------------|
| 0 | 160 | Trip | Trip priority (ID=11800) Eventually Records (ID=11801) | S8[160] |

| | | | | |
|--|--|--|---|--|
| | | | Trip mode (ID=11802) Start Speed (ID=11803) Ignition Off Timeout (ID=11804) Eco Score allowed events (ID=700) Trip Send SMS To (ID=7031) Odometer distance calculation source (ID=11806) | |
|--|--|--|---|--|

7.6.4.9 Odometer distance calculation source (ID=11806)

Sets odometer distance calculation source: 0 – GNSS, 1 – OBD (Bluetooth dongle)

| Minimum value | Maximum value | Default value | Goes with (depends on) parameters | Value type |
|---------------|---------------|---------------|--|------------|
| 0 | 1 | 0 | Trip priority (ID=11800) Eventually Records (ID=11801) Trip mode (ID=11802) Start Speed (ID=11803) Ignition Off Timeout (ID=11804) Eco Score allowed events (ID=700) Trip Send SMS To (ID=7031) Trip SMS Text (ID=8031) | Uint8 |

7.6.4.10 Total Odometer value (11807)

Sets total odometer value.

| Minimum value | Maximum value | Default value | Goes with (depends on) parameters | Value type |
|---------------|---------------|---------------|-----------------------------------|------------|
| 0 | 9999999 | 0 | - | Uint32 |

7.6.5 DOUT control via call scenario parameters

7.6.5.1 Digital Output control (ID=12000)

Disable or enable scenario. If enabled DOUT1 will be controlled via authorized numbers calls.

| Minimum value | Maximum value | Default value | Goes with (depends on) parameters | Value type |
|---------------|---------------|---------------|--|------------|
| 0 | 1 | 0 | DOUT deactivation (ID=12001) Duration timeout (ID=12002) Authorized phone numbers (ID=4000-4009) | Uint8 |

7.6.5.2 DOUT deactivation (ID=12001)

Disable or enable DOUT deactivation by Digital Input. If enabled Digital input 1 will deactivate DOUT 1.

| Minimum value | Maximum value | Default value | Goes with (depends on) parameters | Value type |
|---------------|---------------|---------------|-----------------------------------|------------|
| 0 | 1 | 0 | Digital Output control | Uint8 |

| | | | | |
|--|--|--|---|--|
| | | | (ID=12000) Duration timeout (ID=12002) | |
|--|--|--|---|--|

7.6.5.3 Duration timeout (ID=12002)
DOUT 1 on duration timeout.

| Minimum value | Maximum value | Default value | Goes with (depends on) parameters | Value type |
|---------------|---------------|---------------|---|------------|
| 0 | 2147483647 | 5 | Digital Output control (ID=12000) DOUT deactivation (ID=12001) | Int32 |

7.7 AutoGeofencing scenario parameters

7.7.1 AutoGeofencing priority (ID=20000)

Defines priority of autogeofencing scenario:

0 – disabled, 1 – low, 2 – high, 3 – panic

| Minimum value | Maximum value | Default value | Goes with (depends on) parameters | Value type |
|---------------|---------------|---------------|--|------------|
| 0 | 3 | 0 | Eventual Records (ID=20002) Activation Timeout (ID=20003) Deactivate by (ID=20005) AutoGeofence event generating (ID=20001) Radius (ID=20004) Send sms to (ID=7030) SMS Text (ID=8030) | UInt8 |

7.7.2 Eventual Records (ID=20002)

0 – disable, include parameter to all records, 1 – enable, include parameter to record only if event was generated.

| Minimum value | Maximum value | Default value | Goes with (depends on) parameters | Value type |
|---------------|---------------|---------------|---|------------|
| 0 | 1 | 1 | AutoGeofencing priority (ID=20000) Activation Timeout (ID=20003) Deactivate by (ID=20005) AutoGeofence event generating (ID=20001) Radius (ID=20004) Send sms to (ID=7030) SMS Text (ID=8030) | UInt8 |

7.7.3 Activation Timeout (ID=20003)

Parameter represents AutoGeofencing activation timeout in seconds.

| Minimum value | Maximum value | Default value | Goes with (depends on) parameters | Value type |
|---------------|---------------|---------------|---|------------|
| 0 | 65535 | 60 | AutoGeofencing priority (ID=20000) Eventual Records (ID=20002) Deactivate by (ID=20005) AutoGeofence event generating (ID=20001) Radius (ID=20004) Send sms to (ID=7030) SMS Text (ID=8030) | Uint16 |

7.7.4 Deactivate by (ID=20005)

Parameter defines Autogeofence deactivation source. Value 0 - Power Voltage, 1 - Digital Input 1, 2 – Engine RPM.

| Minimum value | Maximum value | Default value | Goes with (depends on) parameters | Value type |
|---------------|---------------|---------------|--|------------|
| 0 | 2 | 0 | AutoGeofencing priority (ID=20000) Eventual Records (ID=20002) Activation Timeout (ID=20003) AutoGeofence event generating (ID=20001) Radius (ID=20004) Send sms to (ID=7030) SMS Text (ID=8030) | Uint8 |

7.7.5 AutoGeofence event generating (ID=20001)

Generate event: 0 – on exiting zone , 1 – on entering zone; 2 – on both;

| Minimum value | Maximum value | Default value | Goes with (depends on) parameters | Value type |
|---------------|---------------|---------------|--|------------|
| 0 | 2 | 0 | AutoGeofencing priority (ID=20000) Eventual Records (ID=20002) Activation Timeout (ID=20003) Deactivate by (ID=20005) Radius (ID=20004) Send sms to (ID=7030) SMS Text (ID=8030) | Uint8 |

7.7.6 Radius (ID=20004)

Parameter represents radius of circle with center device coordinates after activating AutoGeofence feature.

| Minimum value | Maximum value | Default value | Goes with (depends on) parameters | Value type |
|---------------|---------------|---------------|---|------------|
| 0 | 1000000 | 100 | AutoGeofencing priority (ID=20000) Eventual Records (ID=20002) Activation Timeout (ID=20003) Deactivate by (ID=20005) AutoGeofence event generating (ID=20001) Send sms to (ID=7030) SMS Text (ID=8030) | Uint32 |

7.7.7 AutoGeofence Send SMS to (ID=7030)

Enable/disable sms event sending. 0 – Disable, 1-10 – sms will be sent to configured GSM number.

| Minimum value | Maximum value | Default value | Goes with (depends on) parameters | Value type |
|---------------|---------------|---------------|--|------------|
| 0 | 10 | 0 | AutoGeofencing priority (ID=20000) Eventual Records (ID=20002) Activation Timeout (ID=20003) Deactivate by (ID=20005) AutoGeofence event generating (ID=20001) Radius (ID=20004) SMS Text (ID=8030) GSM Predefined Numbers (ID=6000-6009) | U64 |

7.7.8 SMS Text (ID=8030)

Configure AutoGeofence sms event text here.

| Minimum value | Maximum value | Default value | Goes with (depends on) parameters | Value type |
|---------------|---------------|---------------|---|------------|
| 0 | 160 | AutoGeofence | AutoGeofencing priority (ID=20000) Eventual Records (ID=20002) Activation Timeout (ID=20003) Deactivate by (ID=20005) AutoGeofence event generating (ID=20001) Radius (ID=20004) | S8[180] |

| | | | | |
|--|--|--|-----------------------|--|
| | | | Send sms to (ID=7030) | |
|--|--|--|-----------------------|--|

7.8 Manual Geofence

7.8.1 First Geozone parameters

First Geozone parameters configuration. All 50 geozones are configured with the same logic.

7.8.1.1 #1 Geozone Manual Geofencing priority (ID=20100)

0 – disabled, 1 – low, 2 – high, 3 – panic

| Minimum value | Maximum value | Default value | Goes with (depends on) parameters | Value type |
|---------------|---------------|---------------|---|------------|
| 0 | 3 | 0 | #1 Geozone Manual Geofence event generating (ID=20101) #1 Geozone Eventual Records (ID=20102) #1 Geozone Frame border (ID=20103) #1 Geozone Shape type (ID=20104) #1 Geozone Radius (ID=20105) #1 Geozone X1 (ID=20106) #1 Geozone Y1 (ID=20107) #1 Geozone X2 (ID=20108) #1 Geozone X1 (ID=20109) #1 Geozone OverSpeeding (ID=20110) #1 Geozone Max allowed speed (ID=20111) | Uint8 |

7.8.1.2 #1 Geozone Manual Geofence event generating (ID=20101)

Generate event: 0 – No event, 1 - on exiting zone, 2 – on entering zone; 3 – on both;

| Minimum value | Maximum value | Default value | Goes with (depends on) parameters | Value type |
|---------------|---------------|---------------|--|------------|
| 0 | 3 | 0 | #1 Geozone Manual Geofencing priority (ID=20100) #1 Geozone Eventual Records (ID=20102) #1 Geozone Frame border (ID=20103) #1 Geozone Shape type (ID=20104) #1 Geozone Radius (ID=20105) #1 Geozone X1 (ID=20106) #1 Geozone Y1 (ID=20107) | Uint8 |

| | | | | |
|--|--|--|---|--|
| | | | #1 Geozone X2 (ID=20108) #1 Geozone X1 (ID=20109) #1 Geozone OverSpeeding (ID=20110) #1 Geozone Max allowed speed (ID=20111) | |
|--|--|--|---|--|

7.8.1.3 #1 Geozone Eventual Records (ID=20102)

0 – disable, include parameter to all records, 1 – enable, include parameter to record only if event was generated.

| Minimum value | Maximum value | Default value | Goes with (depends on) parameters | Value type |
|---------------|---------------|---------------|---|------------|
| 0 | 1 | 1 | #1 Geozone Manual Geofencing priority (ID=20100) #1 Geozone Manual Geofence event generating (ID=20101) #1 Geozone Frame border (ID=20103) #1 Geozone Shape type (ID=20104) #1 Geozone Radius (ID=20105) #1 Geozone X1 (ID=20106) #1 Geozone Y1 (ID=20107) #1 Geozone X2 (ID=20108) #1 Geozone X1 (ID=20109) #1 Geozone OverSpeeding (ID=20110) #1 Geozone Max allowed speed (ID=20111) | Uint8 |

7.8.1.4 #1 Geozone Frame border (ID=20103)

Frame border is an additional border around Geofence zone.

| Minimum value | Maximum value | Default value | Goes with (depends on) parameters | Value type |
|---------------|---------------|---------------|--|------------|
| 0 | 1000000 | 1 | #1 Geozone Manual Geofencing priority (ID=20100) #1 Geozone Manual Geofence event generating (ID=20101) #1 Geozone Eventual Records (ID=20102) #1 Geozone Shape type (ID=20104) #1 Geozone Radius (ID=20105) #1 Geozone X1 (ID=20106) #1 Geozone Y1 (ID=20107) | Uint32 |

| | | | | |
|--|--|--|---|--|
| | | | #1 Geozone X2 (ID=20108) #1 Geozone X1 (ID=20109) #1 Geozone OverSpeeding (ID=20110) #1 Geozone Max allowed speed (ID=20111) | |
|--|--|--|---|--|

7.8.1.5 #1 Geozone Shape type (ID=20104)

Shape type: 0 – Circle, 1 - Rectangle.

| Minimum value | Maximum value | Default value | Goes with (depends on) parameters | Value type |
|---------------|---------------|---------------|---|------------|
| 0 | 1 | 0 | #1 Geozone Manual Geofencing priority (ID=20100) #1 Geozone Manual Geofence event generating (ID=20101) #1 Geozone Eventual Records (ID=20102) #1 Geozone Frame border (ID=20103) #1 Geozone Radius (ID=20105) #1 Geozone X1 (ID=20106) #1 Geozone Y1 (ID=20107) #1 Geozone X2 (ID=20108) #1 Geozone X1 (ID=20109) #1 Geozone OverSpeeding (ID=20110) #1 Geozone Max allowed speed (ID=20111) | UInt8 |

7.8.1.6 #1 Geozone Radius (ID=20105)

Radius of circle when circular zone is used (radius in meters).

| Minimum value | Maximum value | Default value | Goes with (depends on) parameters | Value type |
|---------------|---------------|---------------|--|------------|
| 5 | 1000000 | 5 | #1 Geozone Manual Geofencing priority (ID=20100) #1 Geozone Manual Geofence event generating (ID=20101) #1 Geozone Eventual Records (ID=20102) #1 Geozone Frame border (ID=20103) #1 Geozone Shape type (ID=20104) | UInt32 |

| | | | | |
|--|--|--|---|--|
| | | | #1 Geozone X1 (ID=20106) #1 Geozone Y1 (ID=20107) #1 Geozone X2 (ID=20108) #1 Geozone X1 (ID=20109) #1 Geozone OverSpeeding (ID=20110) #1 Geozone Max allowed speed (ID=20111) | |
|--|--|--|---|--|

7.8.1.7 #1 Geozone X1 (ID=20106)

Geofence zone left bottom corner X coordinate (longitude).

| Minimum value | Maximum value | Default value | Goes with (depends on) parameters | Value type |
|---------------|---------------|---------------|---|------------|
| -180 | 180 | 0 | #1 Geozone Manual Geofencing priority (ID=20100) #1 Geozone Manual Geofence event generating (ID=20101) #1 Geozone Eventual Records (ID=20102) #1 Geozone Frame border (ID=20103) #1 Geozone Shape type (ID=20104) #1 Geozone Radius (ID=20105) #1 Geozone Y1 (ID=20107) #1 Geozone X2 (ID=20108) #1 Geozone X1 (ID=20109) #1 Geozone OverSpeeding (ID=20110) #1 Geozone Max allowed speed (ID=20111) | Double |

7.8.1.8 #1 Geozone Y1 (ID=20107)

Geofence zone left bottom corner Y coordinate (latitude).

| Minimum value | Maximum value | Default value | Goes with (depends on) parameters | Value type |
|---------------|---------------|---------------|---|------------|
| -90 | 90 | 0 | #1 Geozone Manual Geofencing priority (ID=20100) #1 Geozone Manual Geofence event generating (ID=20101) #1 Geozone Eventual Records (ID=20102) #1 Geozone Frame border (ID=20103) #1 Geozone Shape type | Double |

| | | | | |
|--|--|--|---|--|
| | | | (ID=20104) #1 Geozone Radius (ID=20105) #1 Geozone X1 (ID=20106) #1 Geozone X2 (ID=20108) #1 Geozone X1 (ID=20109) #1 Geozone OverSpeeding (ID=20110) #1 Geozone Max allowed speed (ID=20111) | |
|--|--|--|---|--|

7.8.1.9 #1 Geozone X2 (ID=20108)

Geofence zone upper right corner X coordinate (longitude).

| Minimum value | Maximum value | Default value | Goes with (depends on) parameters | Value type |
|---------------|---------------|---------------|---|------------|
| -180 | 180 | 0 | #1 Geozone Manual Geofencing priority (ID=20100) #1 Geozone Manual Geofence event generating (ID=20101) #1 Geozone Eventual Records (ID=20102) #1 Geozone Frame border (ID=20103) #1 Geozone Shape type (ID=20104) #1 Geozone Radius (ID=20105) #1 Geozone X1 (ID=20106) #1 Geozone Y1 (ID=20107) #1 Geozone X1 (ID=20109) #1 Geozone OverSpeeding (ID=20110) #1 Geozone Max allowed speed (ID=20111) | Double |

7.8.1.10 #1 Geozone X1 (ID=20109)

Geofence zone upper right corner Y coordinate (latitude).

| Minimum value | Maximum value | Default value | Goes with (depends on) parameters | Value type |
|---------------|---------------|---------------|---|------------|
| -90 | 90 | 0 | #1 Geozone Manual Geofencing priority (ID=20100) #1 Geozone Manual Geofence event generating (ID=20101) #1 Geozone Eventual Records (ID=20102) #1 Geozone Frame border | Double |

| | | | | |
|--|--|--|--|--|
| | | | (ID=20103) #1 Geozone Shape type (ID=20104) #1 Geozone Radius (ID=20105) #1 Geozone X1 (ID=20106) #1 Geozone Y1 (ID=20107) #1 Geozone X2 (ID=20108) #1 Geozone OverSpeeding (ID=20110) #1 Geozone Max allowed speed (ID=20111) | |
|--|--|--|--|--|

7.8.1.11 #1 Geozone OverSpeeding (ID=20110)

Enable/disable overspeeding event in geozone.

| Minimum value | Maximum value | Default value | Goes with (depends on) parameters | Value type |
|---------------|---------------|---------------|---|------------|
| 0 | 1 | 0 | #1 Geozone Manual Geofencing priority (ID=20100) #1 Geozone Manual Geofence event generating (ID=20101) #1 Geozone Eventual Records (ID=20102) #1 Geozone Frame border (ID=20103) #1 Geozone Shape type (ID=20104) #1 Geozone Radius (ID=20105) #1 Geozone X1 (ID=20106) #1 Geozone Y1 (ID=20107) #1 Geozone X2 (ID=20108) #1 Geozone X1 (ID=20109) #1 Geozone Max allowed speed (ID=20111) | Uin8 |

7.8.1.12 #1 Geozone Max allowed speed (ID=20111)

It is max allowed speed which can be reached in geozone (km/h).

| Minimum value | Maximum value | Default value | Goes with (depends on) parameters | Value type |
|---------------|---------------|---------------|---|------------|
| 0 | 1000 | 90 | #1 Geozone Manual Geofencing priority (ID=20100) #1 Geozone Manual Geofence event generating (ID=20101) #1 Geozone Eventual Records (ID=20102) #1 Geozone Frame border | Uin16 |

| | | | | |
|--|--|--|--|--|
| | | | (ID=20103) #1 Geozone Shape type (ID=20104) #1 Geozone Radius (ID=20105) #1 Geozone X1 (ID=20106) #1 Geozone Y1 (ID=20107) #1 Geozone X2 (ID=20108) #1 Geozone X1 (ID=20109) #1 Geozone OverSpeeding (ID=20110) | |
|--|--|--|--|--|

7.8.2 Other Geozones

Other Geozone's parameters have the same logic as shown in Geozone #1.

| GeoFence Zone Number | Geofence Zone's parameters |
|----------------------|----------------------------|
| 1 | 20100-20111 |
| 2 | 20120-20131 |
| 3 | 20140-20151 |
| ... | ... |
| 49 | 21060-21071 |
| 50 | 21080-21091 |

7.8.2.1 Send sms to #1-5 Geozone (ID=7025-7029), #6-50 Geozone (ID=7071-7115)

Enable/disable sms event sending. 0 – Disable, 1-10 – sms will be sent to configured GSM number.

| Minimum value | Maximum value | Default value | Goes with (depends on) parameters | Value type |
|---------------|---------------|---------------|--|------------|
| 0 | 10 | 0 | GSM Predefined Numbers (ID=6000-6009) SMS Text #1-5 Geozone (ID=8025-8029), #6-50 Geozone (ID=8071-8115) | Uint8 |

7.8.2.2 SMS Text #1-5 Geozone (ID=8025-8029), #6-50 Geozone (ID=8071-8115)

Configure geozone # sms event text here.

| Minimum value | Maximum value | Default value | Goes with (depends on) parameters | Value type |
|---------------|---------------|----------------|---|------------|
| 0 | 160 | Geozone Zone # | Send sms to #1-5 Geozone (ID=7025-7029), #6-50 Geozone | S8[160] |

| | | | | |
|--|--|--|----------------|--|
| | | | (ID=7071-7115) | |
|--|--|--|----------------|--|

7.9 GPS Fuel counter

7.9.1 City Consumption L/100km (ID=11900)

Consumption in the city

| Minimum value | Maximum value | Default value | Goes with (depends on) parameters | Value type |
|---------------|---------------|---------------|---|------------|
| 0 | 50 | 0 | Highway Consumption L/100km (ID=11901) Average Consumption L/100km (ID=11902) City Speed [km/h] (ID=11903) Highway Speed [km/h] (ID=11904) Average Speed [km/h] (ID=11905) Correction coefficient (ID=11906) Fuel Consumption on Idling [L/h] (ID=11907) Higher Speeds Add [%] (ID=11908) Highway Consumption every km/h (ID=11909) | Double |

7.9.2 Highway Consumption L/100km (ID=11901)

Consumption on highway

| Minimum value | Maximum value | Default value | Goes with (depends on) parameters | Value type |
|---------------|---------------|---------------|--|------------|
| 0 | 50 | 0 | City Consumption L/100km (ID=11900) Average Consumption L/100km (ID=11902) City Speed [km/h] (ID=11903) Highway Speed [km/h] (ID=11904) Average Speed [km/h] (ID=11905) Correction coefficient (ID=11906) Fuel Consumption on Idling [L/h] (ID=11907) Higher Speeds Add [%] | Double |

| | | | | |
|--|--|--|--|--|
| | | | (ID=11908) Highway Consumption every km/h (ID=11909) | |
|--|--|--|--|--|

7.9.3 Average Consumption L/100km (ID=11902)

Average fuel consumption of the vehicle

| Minimum value | Maximum value | Default value | Goes with (depends on) parameters | Value type |
|---------------|---------------|---------------|--|------------|
| 0 | 50 | 0 | City Consumption L/100km (ID=11900) Highway Consumption L/100km (ID=11901) City Speed [km/h] (ID=11903) Highway Speed [km/h] (ID=11904) Average Speed [km/h] (ID=11905) Correction coefficient (ID=11906) Fuel Consumption on Idling [L/h] (ID=11907) Higher Speeds Add [%] (ID=11908) Highway Consumption every km/h (ID=11909) | Double |

7.9.4 City Speed [km/h] (ID=11903)

Speed in the city

| Minimum value | Maximum value | Default value | Goes with (depends on) parameters | Value type |
|---------------|---------------|---------------|---|------------|
| 0 | 250 | 30 | City Consumption L/100km (ID=11900) Highway Consumption L/100km (ID=11901) Average Consumption L/100km (ID=11902) Highway Speed [km/h] (ID=11904) Average Speed [km/h] (ID=11905) Correction coefficient (ID=11906) Fuel Consumption on Idling [L/h] (ID=11907) | Unit64 |

| | | | | |
|--|--|--|---|--|
| | | | Higher Speeds Add [%] (ID=11908) Highway Consumption every km/h (ID=11909) | |
|--|--|--|---|--|

7.9.5 Highway Speed [km/h] (ID=11904)

Speed on highway

| Minimum value | Maximum value | Default value | Goes with (depends on) parameters | Value type |
|---------------|---------------|---------------|---|------------|
| 0 | 250 | 90 | City Consumption L/100km (ID=11900) Highway Consumption L/100km (ID=11901) Average Consumption L/100km (ID=11902) City Speed [km/h] (ID=11903) Average Speed [km/h] (ID=11905) Correction coefficient (ID=11906) Fuel Consumption on Idling [L/h] (ID=11907) Higher Speeds Add [%] (ID=11908) Highway Consumption every km/h (ID=11909) | Unit64 |

7.9.6 Average Speed [km/h] (ID=11905)

Average speed of the vehicle

| Minimum value | Maximum value | Default value | Goes with (depends on) parameters | Value type |
|---------------|---------------|---------------|--|------------|
| 0 | 250 | 60 | City Consumption L/100km (ID=11900) Highway Consumption L/100km (ID=11901) Average Consumption L/100km (ID=11902) City Speed [km/h] (ID=11903) Highway Speed [km/h] (ID=11904) Correction coefficient (ID=11906) Fuel Consumption on Idling [L/h] (ID=11907) | Unit64 |

| | | | | |
|--|--|--|---|--|
| | | | Higher Speeds Add [%] (ID=11908) Highway Consumption every km/h (ID=11909) | |
|--|--|--|---|--|

7.9.7 Correction coefficient (ID=11906)

Correction coefficient is use for correction every value of fuel consumption which is send to server (Used Fuel * Correction coefficient).

| Minimum value | Maximum value | Default value | Goes with (depends on) parameters | Value type |
|---------------|---------------|---------------|---|------------|
| 0.01 | 2 | 1 | City Consumption L/100km (ID=11900) Highway Consumption L/100km (ID=11901) Average Consumption L/100km (ID=11902) City Speed [km/h] (ID=11903) Highway Speed [km/h] (ID=11904) Average Speed [km/h] (ID=11905) Fuel Consumption on Idling [L/h] (ID=11907) Higher Speeds Add [%] (ID=11908) Highway Consumption every km/h (ID=11909) | Double |

7.9.8 Fuel Consumption on Idling [L/h] (ID=11907)

Sets fuel consumption while vehicle is idling

| Minimum value | Maximum value | Default value | Goes with (depends on) parameters | Value type |
|---------------|---------------|---------------|--|------------|
| 0 | 5 | 1 | City Consumption L/100km (ID=11900) Highway Consumption L/100km (ID=11901) Average Consumption L/100km (ID=11902) City Speed [km/h] (ID=11903) Highway Speed [km/h] (ID=11904) Average Speed [km/h] (ID=11905) Correction coefficient | Double |

| | | | | |
|--|--|--|---|--|
| | | | (ID=11906) Higher Speeds Add [%] (ID=11908) Highway Consumption every km/h (ID=11909) | |
|--|--|--|---|--|

7.9.9 Higher Speeds Add [%] (ID=11908)

| Minimum value | Maximum value | Default value | Goes with (depends on) parameters | Value type |
|---------------|---------------|---------------|--|------------|
| 0 | 250 | 20 | City Consumption L/100km (ID=11900) Highway Consumption L/100km (ID=11901) Average Consumption L/100km (ID=11902) City Speed [km/h] (ID=11903) Highway Speed [km/h] (ID=11904) Average Speed [km/h] (ID=11905) Correction coefficient (ID=11906) Fuel Consumption on Idling [L/h] (ID=11907) Highway Consumption every km/h (ID=11909) | Uint64 |

7.9.10 Highway Consumption every km/h (ID=11909)

| Minimum value | Maximum value | Default value | Goes with (depends on) parameters | Value type |
|---------------|---------------|---------------|--|------------|
| 0 | 100 | 50 | City Consumption L/100km (ID=11900) Highway Consumption L/100km (ID=11901) Average Consumption L/100km (ID=11902) City Speed [km/h] (ID=11903) Highway Speed [km/h] (ID=11904) Average Speed [km/h] (ID=11905) Correction coefficient (ID=11906) Fuel Consumption on Idling | Uint64 |

| | | | | |
|--|--|--|---|--|
| | | | [L/h] (ID=11907) Higher Speeds Add [%] (ID=11908) | |
|--|--|--|---|--|

7.10 Scenarios Accelerometer

7.10.1 Unplug Detection

7.10.1.1 Scenario settings (ID=11500)

Sets priority of the scenario: 0 – Disable, 1 – Low Priority, 2 – High Priority, 3 – Panic Priority

| Minimum value | Maximum value | Default value | Goes with (depends on) parameters | Value type |
|---------------|---------------|---------------|--|------------|
| 0 | 3 | 0 | Eventual records (ID=11501) Unplug detection mode (ID=11502) Send sms to (ID=7067) SMS Text (ID=8067) | UInt8 |

7.10.1.2 Eventual records (ID=11501)

If enabled, only eventual records of unplug detection will be sent. 0 – Disable, 1 - Enable

| Minimum value | Maximum value | Default value | Goes with (depends on) parameters | Value type |
|---------------|---------------|---------------|---|------------|
| 0 | 1 | 1 | Scenario settings (ID=11500) Unplug detection mode (ID=11502) Send sms to (ID=7067) SMS Text (ID=8067) | UInt8 |

7.10.1.3 Unplug detection mode (ID=11502)

Sets Unplug detection mode. 0 – simple, 1 – advanced.

Simple – unplug detection according to external voltage only

Advanced – unplug detection according to: external voltage and accelerometer

| Minimum value | Maximum value | Default value | Goes with (depends on) parameters | Value type |
|---------------|---------------|---------------|--|------------|
| 0 | 1 | 0 | Scenario settings (ID=11500) Eventual records (ID=11501) Send sms to (ID=7067) SMS Text (ID=8067) | UInt8 |

7.10.1.4 Unplug send sms to (ID=7067)

Enable/disable sms event sending. 0 – Disable, 1-10 – sms will be sent to configured GSM number.

| Minimum value | Maximum value | Default value | Goes with (depends on) parameters | Value type |
|---------------|---------------|---------------|-----------------------------------|------------|
| 0 | 10 | 0 | Scenario settings (ID=11500) | UInt8 |

| | | | | |
|--|--|--|--|--|
| | | | Eventual records (ID=11501) Unplug detection mode (ID=11502) SMS Text (ID=8067) GSM Predefined Numbers (ID=6000-6009) | |
|--|--|--|--|--|

7.10.1.5 SMS Text (ID=8067)

Configure unplug detection sms event text here.

| Minimum value | Maximum value | Default value | Goes with (depends on) parameters | Value type |
|---------------|---------------|---------------|---|------------|
| 0 | 160 | Unplug | Scenario settings (ID=11500) Eventual records (ID=11501) Unplug detection mode (ID=11502) Unplug send sms to (ID=7067) | S8[160] |

Note: „Unplug Detection“ work just in device with battery. FMB900 doesn't have this.

7.10.2 Towing Detection

7.10.2.1 Scenario setting (ID=11600)

0 – disabled, 1 – low, 2 – high, 3 – panic

| Minimum value | Maximum value | Default value | Goes with (depends on) parameters | Value type |
|---------------|---------------|---------------|--|------------|
| 0 | 3 | 0 | Eventual Records (ID=11601) Activation Timeout (min) (ID=11602) Event Timeout (s) (ID=11603) Make Call(Sms Event Number ID) (ID=11604) Treshold (mg) (ID=11605) Angle (deg) (ID=11606) Duration (msec) (ID=11607) Towing Send SMS (ID=7066) SMS Text (ID=8066) | Uint8 |

7.10.2.2 Eventual Records (ID=11601)

Generate event: 0 – disable; 1 – enable.

| Minimum value | Maximum value | Default value | Goes with (depends on) parameters | Value type |
|---------------|---------------|---------------|---|------------|
| 0 | 1 | 1 | Scenario setting (ID=11600) Activation Timeout (min) (ID=11602) Event Timeout (s) (ID=11603) Make Call(Sms Event Number ID) (ID=11604) | Uint8 |

| | | | | |
|--|--|--|---|--|
| | | | Treshold (mg) (ID=11605) Angle (deg) (ID=11606) Duration (msec) (ID=11607) Towing Send SMS (ID=7066) SMS Text (ID=8066) | |
|--|--|--|---|--|

7.10.2.3 Activation Timeout (min) (ID=11602)

Activation timeout is time after which FMB920 turns ON Towing detection function if other requirement is met (Ignition OFF state detected).

| Minimum value | Maximum value | Default value | Goes with (depends on) parameters | Value type |
|---------------|---------------|---------------|--|------------|
| 0 | 65535 | 5 | Scenario setting (ID=11600) Eventual Records (ID=11601) Event Timeout (s) (ID=11603) Make Call(Sms Event Number ID) (ID=11604) Treshold (mg) (ID=11605) Angle (deg) (ID=11606) Duration (msec) (ID=11607) Towing Send SMS (ID=7066) SMS Text (ID=8066) | Uint16 |

7.10.2.4 Event Timeout (s) (ID=11603)

Defines time period (in second) to check ignition state when Acceleration or Angle value reach. If towing event is generated during this time period, it is skipped. It allows to filter out redundant towing event while entering car.

| Minimum value | Maximum value | Default value | Goes with (depends on) parameters | Value type |
|---------------|---------------|---------------|---|------------|
| 0 | 60 | 0 | Scenario setting (ID=11600) Eventual Records (ID=11601) Activation Timeout (min) (ID=11602) Make Call(Sms Event Number ID) (ID=11604) Treshold (mg) (ID=11605) Angle (deg) (ID=11606) Duration (msec) (ID=11607) Towing Send SMS (ID=7066) SMS Text (ID=8066) | Uint8 |

7.10.2.5 Towing Make Call(Sms Event Number ID) (ID=11604)

If function enabled makes call to specified phone number (configured in pre defined numbers).

| Minimum value | Maximum value | Default value | Goes with (depends on) parameters | Value type |
|---------------|---------------|---------------|--|------------|
| 0 | 10 | 0 | GSM Predefined Numbers | Uint8 |

| | | | | |
|--|--|--|--|--|
| | | | (ID=6000-6009) Scenario setting (ID=11600) Eventual Records (ID=11601) Activation Timeout (min) (ID=11602) Event Timeout (s) (ID=11603) Treshold (mg) (ID=11605) Angle (deg) (ID=11606) Duration (msec) (ID=11607) Towing Send SMS (ID=7066) SMS Text (ID=8066) | |
|--|--|--|--|--|

7.10.2.6 Treshold (mg) (ID=11605)

Value used to detect towing when ignition is OFF.

| Minimum value | Maximum value | Default value | Goes with (depends on) parameters | Value type |
|---------------|---------------|---------------|---|------------|
| 0.1 | 5 | 0.22 | Scenario setting (ID=11600) Eventual Records (ID=11601) Activation Timeout (min) (ID=11602) Event Timeout (s) (ID=11603) Make Call(Sms Event Number ID) (ID=11604) Angle (deg) (ID=11606) Duration (msec) (ID=11607) Towing Send SMS (ID=7066) SMS Text (ID=8066) | Double |

7.10.2.7 Angle (deg) (ID=11606)

Value used to detect towing when ignition is OFF.

| Minimum value | Maximum value | Default value | Goes with (depends on) parameters | Value type |
|---------------|---------------|---------------|---|------------|
| 0.1 | 5 | 1 | Scenario setting (ID=11600) Eventual Records (ID=11601) Activation Timeout (min) (ID=11602) Event Timeout (s) (ID=11603) Make Call(Sms Event Number ID) (ID=11604) Treshold (mg) (ID=11605) Duration (msec) (ID=11607) Towing Send SMS (ID=7066) SMS Text (ID=8066) | Double |

7.10.2.8 Duration (msec) (ID=11607)

Defines time period to check Acceleration, angle values.

| Minimum value | Maximum value | Default value | Goes with (depends on) parameters | Value type |
|---------------|---------------|---------------|---|------------|
| 1 | 5000 | 1000 | Scenario setting (ID=11600) Eventual Records (ID=11601) Activation Timeout (min) (ID=11602) Event Timeout (s) (ID=11603) Make Call(Sms Event Number ID) (ID=11604) Treshold (mg) (ID=11605) Angle (deg) (ID=11606) Towing Send SMS (ID=7066) SMS Text (ID=8066) | Uint16 |

7.10.2.9 Towing Send SMS (ID=7066)

Enable/disable sms event sending. 0 – Disable, 1-10 – sms will be sent to configured GSM number.

| Minimum value | Maximum value | Default value | Goes with (depends on) parameters | Value type |
|---------------|---------------|---------------|---|------------|
| 0 | 10 | 0 | GSM Predefined Numbers (ID=6000-6009) Scenario setting (ID=11600) Eventual Records (ID=11601) Activation Timeout (min) (ID=11602) Event Timeout (s) (ID=11603) Make Call(Sms Event Number ID) (ID=11604) Treshold (mg) (ID=11605) Angle (deg) (ID=11606) Duration (msec) (ID=11607) SMS Text (ID=8066) | Uint8 |

7.10.2.10 SMS Text (ID=8066)

Configure Towing detection sms event text here.

| Minimum value | Maximum value | Default value | Goes with (depends on) parameters | Value type |
|---------------|---------------|---------------|--|------------|
| 0 | 160 | Towing | Scenario setting (ID=11600) Eventual Records (ID=11601) Activation Timeout (min) (ID=11602) Event Timeout (s) (ID=11603) Make Call(Sms Event Number ID) (ID=11604) Treshold (mg) (ID=11605) Angle (deg) (ID=11606) | S8[180] |

| | | | | |
|--|--|--|---|--|
| | | | Duration (msec) (ID=11607) Towing Send SMS (ID=7066) | |
|--|--|--|---|--|

7.10.3 Crash Detection

7.10.3.1 Scenario settings (ID=11400)

Sets priority of the scenario: 0 – Disable, 1 – Low Priority, 2 – High Priority, 3 – Panic Priority

| Minimum value | Maximum value | Default value | Goes with (depends on) parameters | Value type |
|---------------|---------------|---------------|---|------------|
| 0 | 3 | 0 | Duration [ms] (ID=11401) Treshold [mG] (ID=11402) Crash trace (ID=11406) Crash sms send to (ID= 7037) SMS Text (ID= 8037) | Uint8 |

7.10.3.2 Duration [ms] (ID=11401)

| Minimum value | Maximum value | Default value | Goes with (depends on) parameters | Value type |
|---------------|---------------|---------------|---|------------|
| 0 | 1000 | 5 | Scenario settings (ID=11400) Treshold [mG] (ID=11402) Crash trace (ID=11406) Crash sms send to (ID= 7037) SMS Text (ID= 8037) | Uint8 |

7.10.3.3 Treshold [mG] (ID=11402)

| Minimum value | Maximum value | Default value | Goes with (depends on) parameters | Value type |
|---------------|---------------|---------------|---|------------|
| 0 | 7900 | 1500 | Scenario settings (ID=11400) Duration [ms] (ID=11401) Crash trace (ID=11406) Crash sms send to (ID= 7037) SMS Text (ID= 8037) | Uint16 |

7.10.3.4 Crash trace (ID=11406)

| Minimum value | Maximum value | Default value | Goes with (depends on) parameters | Value type |
|---------------|---------------|---------------|---|------------|
| 0 | 1 | 0 | Scenario settings (ID=11400) Duration [ms] (ID=11401) Treshold [mG] (ID=11402) Crash sms send to (ID= 7037) SMS Text (ID= 8037) | Uint8 |

7.10.3.5 Crash sms send to (ID= 7037)

Enable/disable sms event sending. 0 – Disable, 1-10 – sms will be sent to configured GSM number.

| Minimum value | Maximum value | Default value | Goes with (depends on) parameters | Value type |
|---------------|---------------|---------------|--|------------|
| 0 | 10 | 0 | GSM Predefined Numbers (ID=6000-6009) Scenario settings (ID=11400) Duration [ms] (ID=11401) Treshold [mG] (ID=11402) Crash trace (ID=11406) SMS Text (ID= 8037) | Uint8 |

7.10.3.6 SMS Text (ID=8037)

Configure Crash sms event text here.

| Minimum value | Maximum value | Default value | Goes with (depends on) parameters | Value type |
|---------------|---------------|---------------|--|------------|
| 0 | 160 | Crash | Scenario settings (ID=11400) Duration [ms] (ID=11401) Treshold [mG] (ID=11402) Crash trace (ID=11406) Crash sms send to (ID= 7037) | S8[160] |

7.10.4 Excessive idling

7.10.4.1 Excessive idling priority (ID=11200)

Defines priority of Excessive idling scenario:

0 – disabled, 1 – low, 2 – high, 3 – panic

| Minimum value | Maximum value | Default value | Goes with (depends on) parameters | Value type |
|---------------|---------------|---------------|---|------------|
| 0 | 3 | 0 | Eventual records (ID=11203) Excessive idling minimum stop duration (ID=11205) Excessive idling minimum move duration (ID=11206) Excessive idling output control (ID=11204) Excessive idling output on duration (ID=11201) Excessive idling output off duration (ID=11202) Excessive idling Send SMS To (ID=7033) Excessive idling SMS Text (ID=8033) | Uint8 |

7.10.4.2 Eventual records (ID=11203)

Disables (0) or enables (1) eventual records with idling value

| Minimum value | Maximum value | Default value | Goes with (depends on) parameters | Value type |
|---------------|---------------|---------------|--|------------|
| 0 | 1 | 1 | Excessive idling priority (ID=11200) Excessive idling minimum stop duration (ID=11205) Excessive idling minimum move duration (ID=11206) Excessive idling output control (ID=11204) Excessive idling output on duration (ID=11201) Excessive idling output off duration (ID=11202) Excessive idling Send SMS To (ID=7033) Excessive idling SMS Text (ID=8033) | UInt8 |

7.10.4.3 Excessive idling minimum stop duration (ID=11205)

Defines minimum time in seconds of vehicle idling before scenario enables.

| Minimum value | Maximum value | Default value | Goes with (depends on) parameters | Value type |
|---------------|---------------|---------------|--|------------|
| 0 | 255 | 5 | Excessive idling priority (ID=11200) Eventual records (ID=11203) Excessive idling minimum move duration (ID=11206) Excessive idling output control (ID=11204) Excessive idling output on duration (ID=11201) Excessive idling output off duration (ID=11202) Excessive idling Send SMS To (ID=7033) Excessive idling SMS Text (ID=8033) | UInt8 |

7.10.4.4 Excessive idling minimum move duration (ID=11206)

Defines minimum time in seconds of vehicle idling before scenario disables.

| Minimum value | Maximum value | Default value | Goes with (depends on) parameters | Value type |
|---------------|---------------|---------------|--------------------------------------|------------|
| 0 | 255 | 2 | Excessive idling priority (ID=11200) | UInt8 |

| | | | | |
|--|--|--|--|--|
| | | | Eventual records (ID=11203) Excessive idling minimum stop duration (ID=11205) Excessive idling output control (ID=11204) Excessive idling output on duration (ID=11201) Excessive idling output off duration (ID=11202) Excessive idling Send SMS To (ID=7033) Excessive idling SMS Text (ID=8033) | |
|--|--|--|--|--|

7.10.4.5 Excessive idling output control (ID=11204)

Enables (1) or disables (0) Excessive idling output control

| Minimum value | Maximum value | Default value | Goes with (depends on) parameters | Value type |
|---------------|---------------|---------------|---|------------|
| 0 | 1 | 0 | Excessive idling priority (ID=11200) Eventual records (ID=11203) Excessive idling minimum stop duration (ID=11205) Excessive idling minimum move duration (ID=11206) Excessive idling output on duration (ID=11201) Excessive idling output off duration (ID=11202) Excessive idling Send SMS To (ID=7033) Excessive idling SMS Text (ID=8033) | UInt8 |

7.10.4.6 Excessive idling output on duration (ID=11201)

Output ON duration in seconds

| Minimum value | Maximum value | Default value | Goes with (depends on) parameters | Value type |
|---------------|---------------|---------------|---|------------|
| 100 | 5000 | 200 | Excessive idling priority (ID=11200) Eventual records (ID=11203) Excessive idling minimum stop duration (ID=11205) Excessive idling minimum move duration (ID=11206) | Int32 |

| | | | | |
|--|--|--|--|--|
| | | | Excessive idling output control (ID=11204) Excessive idling output off duration (ID=11202) Excessive idling Send SMS To (ID=7033) Excessive idling SMS Text (ID=8033) | |
|--|--|--|--|--|

7.10.4.7 Excessive idling output off duration (ID=11202)

Output OFF duration in seconds

| Minimum value | Maximum value | Default value | Goes with (depends on) parameters | Value type |
|---------------|---------------|---------------|--|------------|
| 0 | 5000 | 200 | Excessive idling priority (ID=11200) Eventual records (ID=11203) Excessive idling minimum stop duration (ID=11205) Excessive idling minimum move duration (ID=11206) Excessive idling output control (ID=11204) Excessive idling output on duration (ID=11201) Excessive idling Send SMS To (ID=7033) Excessive idling SMS Text (ID=8033) | Int32 |

7.10.4.8 Excessive idling Send SMS To (ID=7033)

Enable/disable sms event sending. 0 – Disable, 1-10 – sms will be sent to configured GSM number.

| Minimum value | Maximum value | Default value | Goes with (depends on) parameters | Value type |
|---------------|---------------|---------------|--|------------|
| 0 | 10 | 0 | GSM Predefined Numbers (ID=6000-6009) Excessive idling priority (ID=11200) Eventual records (ID=11203) Excessive idling minimum stop duration (ID=11205) Excessive idling minimum move duration (ID=11206) Excessive idling output control (ID=11204) Excessive idling output on | UInt8 |

| | | | | |
|--|--|--|---|--|
| | | | duration (ID=11201) Excessive idling output off duration (ID=11202) Excessive idling SMS Text (ID=8033) | |
|--|--|--|---|--|

7.10.4.9 Excessive idling SMS Text (ID=8033)

Configure excessive idling sms event text here.

| Minimum value | Maximum value | Default value | Goes with (depends on) parameters | Value type |
|---------------|---------------|---------------|--|------------|
| 0 | 160 | Idling Event | Excessive idling priority (ID=11200) Eventual records (ID=11203) Excessive idling minimum stop duration (ID=11205) Excessive idling minimum move duration (ID=11206) Excessive idling output control (ID=11204) Excessive idling output on duration (ID=11201) Excessive idling output off duration (ID=11202) Excessive idling Send SMS To (ID=7033) | S8[160] |

7.11 Bluetooth

7.11.1.1 BT Radio (ID=800)

Enables or disable Bluetooth feature. 0 – Disabled, 1 – Enable hidden, 2 – Enable visible

| Minimum value | Maximum value | Default value | Goes with (depends on) parameters | Value type |
|---------------|---------------|---------------|---|------------|
| 0 | 2 | 0 | Local name (ID 801) Local PIN (ID=802) Security mode (ID=803) External MAC (ID=804) External name (ID=805) External PIN (ID=806) Connection mode (ID=807) Authorized devices MAC list (ID=830 - 834) | Uint8 |

7.11.1.2 Local name (ID 801)

Parameter defines a visible name of FMB920 device.

| Minimum value | Maximum value | Default value | Goes with (depends on) parameters | Value type |
|---------------|---------------|---------------|-----------------------------------|------------|
| | | | | |

| | | | | |
|-----------|------------|-----------------------------|---|--------|
| 0 Symbols | 30 Symbols | FMBxx_(last 7 IMEI numbers) | BT Radio (ID=800) Local PIN (ID=802) Security mode (ID=803) External MAC (ID=804) External name (ID=805) External PIN (ID=806) Connection mode (ID=807) Authorized devices MAC list (ID=830 - 834) | S8[30] |
|-----------|------------|-----------------------------|---|--------|

7.11.1.3 Local PIN (ID=802)

Parameter Lets to configure Bluetooth PIN.

| Minimum value | Maximum value | Default value | Goes with (depends on) parameters | Value type |
|---------------|---------------|---------------|--|------------|
| 0 Symbols | 4 Symbols | 5555 | BT Radio (ID=800) Local name (ID 801) Security mode (ID=803) External MAC (ID=804) External name (ID=805) External PIN (ID=806) Connection mode (ID=807) Authorized devices MAC list (ID=830 - 834) | String |

7.11.1.4 Security mode (ID=803)

Parameter defines a security mode of FMBX device. 0 – PIN only, 1 – PIN and MAC, 2 – MAC only, 3 – None.

| Minimum value | Maximum value | Default value | Goes with (depends on) parameters | Value type |
|---------------|---------------|---------------|--|------------|
| 0 | 3 | 0 | BT Radio (ID=800) Local name (ID 801) Local PIN (ID=802) External MAC (ID=804) External name (ID=805) External PIN (ID=806) Connection mode (ID=807) Authorized devices MAC list (ID=830 - 834) | Uint8 |

7.11.1.5 External MAC (ID=804)

Defines external device's MAC, for FMB920 to auto connect to.

| Minimum value | Maximum value | Default value | Goes with (depends on) parameters | Value type |
|---------------|---------------|---------------|--|------------|
| 0 symbols | 12 symbols | 0 | BT Radio (ID=800) Local name (ID 801) Local PIN (ID=802) | string |

| | | | | |
|--|--|--|--|--|
| | | | Security mode (ID=803) External name (ID=805) External PIN (ID=806) Connection mode (ID=807) Authorized devices MAC list (ID=830 - 834) | |
|--|--|--|--|--|

7.11.1.6 External name (ID=805)

Defines external device's name, for FMB920 to auto connect to.

| Minimum value | Maximum value | Default value | Goes with (depends on) parameters | Value type |
|---------------|---------------|---------------|---|------------|
| 0 symbols | 30 symbols | 0 | BT Radio (ID=800) Local name (ID 801) Local PIN (ID=802) Security mode (ID=803) External MAC (ID=804) External PIN (ID=806) Connection mode (ID=807) Authorized devices MAC list (ID=830 - 834) | string |

7.11.1.7 External PIN (ID=806)

Defines external device's PIN, for FMB920 to auto connect to.

| Minimum value | Maximum value | Default value | Goes with (depends on) parameters | Value type |
|---------------|---------------|---------------|--|------------|
| 0 symbols | 8 symbols | 0 | BT Radio (ID=800) Local name (ID 801) Local PIN (ID=802) Security mode (ID=803) External MAC (ID=804) External name (ID=805) Connection mode (ID=807) Authorized devices MAC list (ID=830 - 834) | string |

7.11.1.8 Connection mode (ID=807)

Defines a mode in which FMB920 will connect to external devices. 0 – None,

1 – FMB920 will connect to Hands Free Headset, 2 – FMB920 will connect to OBDII

Bluetooth dongle, 3 – Data Link.

| Minimum value | Maximum value | Default value | Goes with (depends on) parameters | Value type |
|---------------|---------------|---------------|---|------------|
| 0 | 3 | 0 | BT Radio (ID=800) Local name (ID 801) Local PIN (ID=802) Security mode (ID=803) External MAC (ID=804) | Uint8 |

| | | | | |
|--|--|--|---|--|
| | | | External name (ID=805) External PIN (ID=806) Authorized devices MAC list (ID=830 - 834) | |
|--|--|--|---|--|

7.11.1.9 Authorized devices MAC list (ID=830 - 834)

Parameter allows to add an authorized devices MAC for connection to FMB920

| Minimum value | Maximum value | Default value | Goes with (depends on) parameters | Value type |
|---------------|---------------|---------------|--|------------|
| 0 symbols | 12 symbols | - | BT Radio (ID=800) Local name (ID 801) Local PIN (ID=802) Security mode (ID=803) External MAC (ID=804) External name (ID=805) External PIN (ID=806) Connection mode (ID=807) | String |

7.12 I/O parameters

I/O properties are additional data sources which are recorded along with usual GPS data.

7.12.1 I/O#1 property parameter priority Ignition (ID=50000)

Parameter defines I/O property type of priority: 0 is disabled, 1 – low, 2 – high, 3 - panic.

| Minimum value | Maximum value | Default value | Goes with (depends on) parameters | Value type |
|---------------|---------------|---------------|---|------------|
| 0 | 3 | 1 | I/O#1 operand (ID=50001) I/O#1 High level (ID=50002) I/O#1 Low level (ID=50003) I/O#1 Event only (ID=50004) I/O#1 averaging length (ID=50005) I/O#1 send SMS (ID=7000) I/O#1 SMS text (ID=8000) | Uint8 |

7.12.2 I/O#1 operand (ID=50001)

Parameter defines when event is sent: 0 – on range exit, 1 – on range entrance, 2 – both, 3 – monitoring, 4 – hysteresis, 5 – on changes, 6 – on delta change.

| Minimum value | Maximum value | Default value | Goes with (depends on) parameters | Value type |
|---------------|---------------|---------------|--|------------|
| 0 | 6 | 0 | I/O#1 property parameter priority Ignition (ID=50000) I/O#1 High level (ID=50002) I/O#1 Low level (ID=50003) I/O#1 Event only (ID=50004) I/O#1 averaging length (ID=50005) | Uint8 |

| | | | | |
|--|--|--|--|--|
| | | | I/O#1 send SMS (ID=7000) I/O#1 SMS text (ID=8000) | |
|--|--|--|--|--|

7.12.3 I/O#1 High level (ID=50002)

Parameter defines high value of triggered I/O property. This parameter is used to set thresholds for I/O properties to generate events.

| Minimum value | Maximum value | Default value | Goes with (depends on) parameters | Value type |
|---------------|---------------|---------------|---|------------|
| 0 | 1 | 0 | I/O#1 property parameter priority Ignition (ID=50000) I/O#1 operand (ID=50001) I/O#1 Low level (ID=50003) I/O#1 Event only (ID=50004) I/O#1 averaging length (ID=50005) I/O#1 send SMS (ID=7000) I/O#1 SMS text (ID=8000) | UInt8 |

7.12.4 I/O#1 Low level (ID=50003)

Parameter defines low value of triggered I/O property. This parameter is used to set thresholds for I/O properties to generate events.

| Minimum value | Maximum value | Default value | Goes with (depends on) parameters | Value type |
|---------------|---------------|---------------|--|------------|
| 0 | 1 | 0 | I/O#1 property parameter priority Ignition (ID=50000) I/O#1 operand (ID=50001) I/O#1 High level (ID=50002) I/O#1 Event only (ID=50004) I/O#1 averaging length (ID=50005) I/O#1 send SMS (ID=7000) I/O#1 SMS text (ID=8000) | UInt8 |

7.12.5 I/O#1 Event only (ID=50004)

Parameter defines when IO element value is sent: 0 – with every AVL packet, 1 – on event only. On event means that IO element value is included to AVL packet only when this particular event happens. With regular, periodic records such IO element value is not included.

| Minimal value | Maximum value | Default value | Goes with (depends on) parameters | Value type |
|---------------|---------------|---------------|---|------------|
| 0 | 1 | 0 | I/O#1 property parameter priority Ignition (ID=50000) I/O#1 operand (ID=50001) I/O#1 High level (ID=50002) I/O#1 Low level (ID=50003) I/O#1 averaging length (ID=50005) I/O#1 send SMS (ID=7000) I/O#1 SMS text (ID=8000) | Uint8 |

7.12.6 I/O#1 averaging length (ID=50005)

Parameter defines I/O property sample length to average.

| Minimum value | Maximum value | Default value | Goes with (depends on) parameters | Value type |
|---------------|---------------|---------------|---|------------|
| 0 | 65535 | 10 | I/O#1 property parameter priority Ignition (ID=50000) I/O#1 operand (ID=50001) I/O#1 High level (ID=50002) I/O#1 Low level (ID=50003) I/O#1 Event only (ID=50004) I/O#1 send SMS (ID=7000) I/O#1 SMS text (ID=8000) | Uint16 |

7.12.7 I/O#1 send SMS (ID=7000)

Enable/disable sms event sending. 0 – Disable, 1-10 – sms will be sent to configured GSM number.

| Minimum value | Maximum value | Default value | Goes with (depends on) parameters | Value type |
|---------------|---------------|---------------|--|------------|
| 0 | 10 | 0 | GSM Predefined Numbers (ID=6000-6009) I/O#1 property parameter priority Ignition (ID=50000) I/O#1 operand (ID=50001) I/O#1 High level (ID=50002) I/O#1 Low level (ID=50003) I/O#1 Event only (ID=50004) I/O#1 SMS text (ID=8000) | Uint8 |

7.12.8 I/O#1 SMS text (ID=8000)

Configure I/O#1 sms event text here.

| Minimum value | Maximum value | Default value | Goes with (depends on) parameters | Value type |
|---------------|---------------|---------------|---|------------|
| 0 | 160 | Ignition | I/O#1 property parameter priority Ignition (ID=50000) I/O#1 operand (ID=50001) I/O#1 High level (ID=50002) I/O#1 Low level (ID=50003) I/O#1 Event only (ID=50004) I/O#1 send SMS (ID=7000) | S8[160] |

7.12.9 I\O elements parameters and types.

Priority: 0 – disabled, 1 – low, 2 – high, 3 – panic.

Operand: 0 – On Exit, 1 – On Entrance, 2 – On Both, 3 – Monitoring, 4 – On Hysteresis, 5 – On Change, 6 – On Delta Change.

Event only: 0 – No, 1 – Yes.

| Parameter ID | Parameter Type | Default value | Value range | | Parameter name |
|--------------|----------------|---------------|-------------|-------|-----------------------|
| | | | Min | Max | |
| 50000 | Uint8 | 1 | 0 | 3 | Ignition Priority |
| 50001 | Uint8 | 5 | 0 | 6 | Ignition Operand |
| 50002 | Uint8 | 0 | 0 | 1 | Ignition High level |
| 50003 | Uint8 | 0 | 0 | 1 | Ignition Low level |
| 50004 | Uint8 | 0 | 0 | 1 | Ignition Event only |
| 50005 | Uint16 | 10 | 0 | 65535 | Ignition Average |
| 7000 | Uint8 | 0 | 0 | 10 | Send SMS |
| 8000 | String | 0 | 0 | 160 | SMS Text |
| 50010 | Uint8 | 1 | 0 | 3 | Movement Priority |
| 50011 | Uint8 | 5 | 0 | 6 | Movement Operand |
| 50012 | Uint8 | 0 | 0 | 1 | Movement High level |
| 50013 | Uint8 | 0 | 0 | 1 | Movement Low level |
| 50014 | Uint8 | 0 | 0 | 1 | Movement Event only |
| 50015 | Uint16 | 1 | 0 | 65535 | Movement Average |
| 7001 | Uint8 | 0 | 0 | 10 | Send SMS |
| 8001 | String | 0 | 0 | 160 | SMS Text |
| 50020 | Uint8 | 1 | 0 | 3 | Data Mode Priority |
| 50021 | Uint8 | 3 | 0 | 6 | Data Mode Operand |
| 50022 | Uint8 | 0 | 0 | 5 | Data Mode High level |
| 50023 | Uint8 | 0 | 0 | 5 | Data Mode Low level |
| 50024 | Uint8 | 0 | 0 | 1 | Data Mode Event only |
| 7002 | Uint8 | 0 | 0 | 10 | Send SMS |
| 8002 | String | 0 | 0 | 160 | SMS Text |
| 50030 | Uint8 | 1 | 0 | 3 | GSM Signal Priority |
| 50031 | Uint8 | 3 | 0 | 6 | GSM Signal Operand |
| 50032 | Uint8 | 0 | 0 | 5 | GSM Signal High level |
| 50033 | Uint8 | 0 | 0 | 5 | GSM Signal Low level |
| 50034 | Uint8 | 0 | 0 | 1 | GSM Signal Event only |
| 50035 | Uint16 | 1 | 0 | 65535 | GSM Signal Average |

| Parameter ID | Parameter Type | Default value | Value range | | Parameter name |
|--------------|----------------|---------------|-------------|-------|-----------------------------|
| | | | Min | Max | |
| 7003 | Uint8 | 0 | 0 | 10 | Send SMS |
| 8003 | String | 0 | 0 | 160 | SMS Text |
| 50040 | Uint8 | 1 | 0 | 3 | Deep Sleep Priority |
| 50041 | Uint8 | 3 | 0 | 6 | Deep Sleep Operand |
| 50042 | Uint8 | 0 | 0 | 2 | Deep Sleep High level |
| 50043 | Uint8 | 0 | 0 | 2 | Deep Sleep Low level |
| 50044 | Uint8 | 0 | 0 | 1 | Deep Sleep Event only |
| 7004 | Uint8 | 0 | 0 | 10 | Send SMS |
| 8004 | String | 0 | 0 | 160 | SMS Text |
| 50050 | Uint8 | 1 | 0 | 3 | GNSS Status Priority |
| 50051 | Uint8 | 3 | 0 | 6 | GNSS Status Operand |
| 50052 | Uint8 | 0 | 0 | 5 | GNSS Status High level |
| 50053 | Uint8 | 0 | 0 | 5 | GNSS Status Low level |
| 50053 | Uint8 | 0 | 0 | 1 | GNSS Status Event only |
| 7005 | Uint8 | 0 | 0 | 10 | Send SMS |
| 8005 | String | 0 | 0 | 160 | SMS Text |
| 50060 | Uint8 | 0 | 0 | 3 | GNSS PDOP Priority |
| 5061 | Uint8 | 3 | 0 | 6 | GNSS PDOP Operand |
| 5062 | Uint16 | 0 | 0 | 1000 | GNSS PDOP High level |
| 5063 | Uint16 | 0 | 0 | 1000 | GNSS PDOP Low level |
| 5064 | Uint8 | 0 | 0 | 1 | GNSS PDOP Event only |
| 5065 | Uint16 | 10 | 0 | 65535 | GNSS PDOP Average |
| 7006 | Uint8 | 0 | 0 | 10 | Send SMS |
| 8006 | String | 0 | 0 | 160 | SMS Text |
| 50070 | Uint8 | 1 | 0 | 3 | GNSS HDOP Priority |
| 50071 | Uint8 | 3 | 0 | 6 | GNSS HDOP Operand |
| 50072 | Uint16 | 0 | 0 | 1000 | GNSS HDOP High level |
| 50073 | Uint16 | 0 | 0 | 1000 | GNSS HDOP Low level |
| 50074 | Uint8 | 0 | 0 | 1 | GNSS HDOP Event only |
| 50075 | Uint16 | 10 | 0 | 65535 | GNSS HDOP Average |
| 7007 | Uint8 | 0 | 0 | 10 | Send SMS |
| 8007 | String | 0 | 0 | 160 | SMS Text |
| 50080 | Uint8 | 1 | 0 | 3 | External Voltage Priority |
| 50081 | Uint8 | 6 | 0 | 6 | External Voltage Operand |
| 50082 | Uint16 | 1000 | 0 | 60000 | External Voltage High level |
| 50083 | Uint16 | 0 | 0 | 60000 | External Voltage Low level |
| 50084 | Uint8 | 0 | 0 | 1 | External Voltage Event only |
| 50085 | Uint16 | 10 | 0 | 65535 | External Voltage Average |
| 7008 | Uint8 | 0 | 0 | 10 | Send SMS |
| 8008 | String | 0 | 0 | 160 | SMS Text |
| 50090 | Uint8 | 1 | 0 | 3 | Speed Priority |
| 50091 | Uint8 | 3 | 0 | 6 | Speed Operand |
| 50092 | Uint16 | 0 | 0 | 300 | Speed High level |
| 50093 | Uint16 | 0 | 0 | 300 | Speed Low level |
| 50094 | Uint8 | 0 | 0 | 1 | Speed Event only |
| 50095 | Uint16 | 1 | 0 | 65535 | Speed Average |
| 7009 | Uint8 | 0 | 0 | 10 | Send SMS |

| Parameter ID | Parameter Type | Default value | Value range | | Parameter name |
|--------------|----------------|---------------|-------------|---------|--------------------------------|
| | | | Min | Max | |
| 8009 | String | 0 | 0 | 160 | SMS Text |
| 50100 | Uint8 | 0 | 0 | 3 | GSM Cell ID Priority |
| 50101 | Uint8 | 3 | 0 | 6 | GSM Cell ID Operand |
| 50102 | Uint32 | 0 | 0 | 999999 | GSM Cell ID High level |
| 50103 | Uint32 | 0 | 0 | 999999 | GSM Cell ID Low level |
| 50104 | Uint8 | 0 | 0 | 1 | GSM Cell ID Event only |
| 7010 | Uint8 | 0 | 0 | 10 | Send SMS |
| 8010 | String | 0 | 0 | 160 | SMS Text |
| 50110 | Uint8 | 0 | 0 | 3 | GSM Area Code Priority |
| 50111 | Uint8 | 3 | 0 | 6 | GSM Area Code Operand |
| 50112 | Uint32 | 0 | 0 | 999999 | GSM Area Code High level |
| 50113 | Uint32 | 0 | 0 | 999999 | GSM Area Code Low level |
| 50114 | Uint8 | 0 | 0 | 1 | GSM Area Code Event only |
| 7011 | Uint8 | 0 | 0 | 10 | Send SMS |
| 8011 | String | 0 | 0 | 160 | SMS Text |
| 50120 | Uint8 | 1 | 0 | 3 | Battery Voltage Priority |
| 50121 | Uint8 | 3 | 0 | 6 | Battery Voltage Operand |
| 50122 | Uint16 | 0 | 0 | 5000 | Battery Voltage High level |
| 50123 | Uint16 | 0 | 0 | 5000 | Battery Voltage Low level |
| 50124 | Uint8 | 0 | 0 | 1 | Battery Voltage Event only |
| 50125 | Uint8 | 0 | 0 | 10 | Battery Voltage Average |
| 7012 | Uint8 | 0 | 0 | 10 | Send SMS |
| 8012 | String | 0 | 0 | 160 | SMS Text |
| 50130 | Uint8 | 1 | 0 | 3 | Battery Current Priority |
| 50131 | Uint8 | 3 | 0 | 6 | Battery Current Operand |
| 50132 | Uint16 | 0 | 0 | 5000 | Battery Current High level |
| 50133 | Uint16 | 0 | 0 | 5000 | Battery Current Low level |
| 50134 | Uint8 | 0 | 0 | 1 | Battery Current Event only |
| 50135 | Uint8 | 0 | 0 | 10 | Battery Current Average |
| 7013 | Uint8 | 0 | 0 | 10 | Send SMS |
| 8013 | String | 0 | 0 | 160 | SMS Text |
| 50140 | Uint8 | 0 | 0 | 3 | Active GSM Operator Priority |
| 50141 | Uint8 | 3 | 0 | 6 | Active GSM Operator Operand |
| 50142 | Uint32 | 0 | 0 | 999999 | Active GSM Operator High level |
| 50143 | Uint32 | 0 | 0 | 999999 | Active GSM Operator Low level |
| 50144 | Uint8 | 0 | 0 | 1 | Active GSM Operator Event only |
| 7014 | Uint8 | 0 | 0 | 10 | Send SMS |
| 8014 | String | 0 | 0 | 160 | SMS Text |
| 50150 | Uint8 | 0 | 0 | 3 | Trip Odometer Priority |
| 50151 | Uint8 | 3 | 0 | 6 | Trip Odometer Operand |
| 50152 | Uint32 | 0 | 0 | 1000000 | Trip Odometer High level |
| 50153 | Uint32 | 0 | 0 | 1000000 | Trip Odometer Low level |
| 50154 | Uint8 | 0 | 0 | 1 | Trip Odometer Event only |
| 7015 | Uint8 | 0 | 0 | 10 | Send SMS |
| 8015 | String | 0 | 0 | 160 | SMS Text |
| 50160 | Uint8 | 0 | 0 | 3 | Total Odometer Priority |
| 50161 | Uint8 | 3 | 0 | 6 | Total Odometer Operand |

| Parameter ID | Parameter Type | Default value | Value range | | Parameter name |
|--------------|----------------|---------------|-------------|----------|-----------------------------|
| | | | Min | Max | |
| 50162 | Uint32 | 0 | 0 | 10000000 | Total Odometer High level |
| 50163 | Uint32 | 0 | 0 | 10000000 | Total Odometer Low level |
| 50164 | Uint8 | 0 | 0 | 1 | Total Odometer Event only |
| 7016 | Uint8 | 0 | 0 | 10 | Send SMS |
| 8016 | String | 0 | 0 | 160 | SMS Text |
| 50170 | Uint8 | 0 | 0 | 3 | Digital Input 1 Priority |
| 50171 | Uint8 | 3 | 0 | 6 | Digital Input 1 Operand |
| 50172 | Uint8 | 0 | 0 | 1 | Digital Input 1 High level |
| 50173 | Uint8 | 0 | 0 | 1 | Digital Input 1 Low level |
| 50174 | Uint8 | 0 | 0 | 1 | Digital Input 1 Event only |
| 50175 | Uint16 | 1 | 0 | 65535 | Digital Input 1 Average |
| 7017 | Uint8 | 0 | 0 | 10 | Send SMS |
| 8017 | String | 0 | 0 | 160 | SMS Text |
| 50180 | Uint8 | 0 | 0 | 3 | Analog Input 1 Priority |
| 50181 | Uint8 | 3 | 0 | 6 | Analog Input 1 Operand |
| 50182 | Uint16 | 0 | 0 | 30000 | Analog Input 1 High level |
| 50183 | Uint16 | 0 | 0 | 30000 | Analog Input 1 Low level |
| 50184 | Uint8 | 0 | 0 | 1 | Analog Input 1 Event only |
| 50185 | Uint16 | 10 | 0 | 65535 | Analog Input 1 Average |
| 7018 | Uint8 | 0 | 0 | 10 | Send SMS |
| 8018 | String | 0 | 0 | 160 | SMS Text |
| 50190 | Uint8 | 0 | 0 | 3 | Digital Output 1 Priority |
| 50191 | Uint8 | 0 | 0 | 6 | Digital Output 1 Operand |
| 50192 | Uint8 | 0 | 0 | 1 | Digital Output 1 High level |
| 50193 | Uint8 | 0 | 0 | 1 | Digital Output 1 Low level |
| 50194 | Uint8 | 0 | 0 | 1 | Digital Output 1 Event only |
| 50195 | Uint16 | 1 | 0 | 65535 | Digital Output 1 Average |
| 7019 | Uint8 | 0 | 0 | 10 | Send SMS |
| 8019 | String | 0 | 0 | 160 | SMS Text |
| 50200 | Uint8 | 0 | 0 | 3 | Fuel Used GPS Priority |
| 50201 | Uint8 | 3 | 0 | 6 | Fuel Used GPS Operand |
| 50202 | Uint32 | 0 | 0 | 1000000 | Fuel Used GPS High level |
| 50203 | Uint32 | 0 | 0 | 1000000 | Fuel Used GPS Low level |
| 50204 | Uint8 | 0 | 0 | 1 | Fuel Used GPS Event only |
| 50205 | Uint16 | 1 | 0 | 65535 | Fuel Used GPS Average |
| 7020 | Uint8 | 0 | 0 | 10 | Send SMS |
| 8020 | String | 0 | 0 | 160 | SMS Text |
| 50210 | Uint8 | 0 | 0 | 3 | Fuel Rate GPS Priority |
| 50211 | Uint8 | 3 | 0 | 6 | Fuel Rate GPS Operand |
| 50212 | Uint32 | 0 | 0 | 1000000 | Fuel Rate GPS High level |
| 50213 | Uint32 | 0 | 0 | 1000000 | Fuel Rate GPS Low level |
| 50214 | Uint8 | 0 | 0 | 1 | Fuel Rate GPS Event only |
| 50215 | Uint16 | 1 | 0 | 65535 | Fuel Rate GPS Average |
| 7021 | Uint8 | 0 | 0 | 10 | Send SMS |
| 8021 | String | 0 | 0 | 160 | SMS Text |
| 50220 | Uint8 | 0 | 0 | 3 | Axis X Priority |
| 50221 | Uint8 | 3 | 0 | 6 | Axis X Operand |

| Parameter ID | Parameter Type | Default value | Value range | | Parameter name |
|--------------|----------------|---------------|-------------|-------|----------------------|
| | | | Min | Max | |
| 50222 | Uint16 | 0 | -8000 | 8000 | Axis X High level |
| 50223 | Uint16 | 0 | -8000 | 8000 | Axis X Low level |
| 50224 | Uint8 | 0 | 0 | 1 | Axis X Event only |
| 50225 | Uint16 | 1 | 0 | 65535 | Axis X Average |
| 7022 | Uint8 | 0 | 0 | 10 | Send SMS |
| 8022 | String | 0 | 0 | 160 | SMS Text |
| 50230 | Uint8 | 0 | 0 | 3 | Axis Y Priority |
| 50231 | Uint8 | 3 | 0 | 6 | Axis Y Operand |
| 50232 | Uint16 | 0 | -8000 | 8000 | Axis Y High level |
| 50233 | Uint16 | 0 | -8000 | 8000 | Axis Y Low level |
| 50234 | Uint8 | 0 | 0 | 1 | Axis Y Event only |
| 50235 | Uint16 | 1 | 0 | 65535 | Axis Y Average |
| 7023 | Uint8 | 0 | 0 | 10 | Send SMS |
| 8023 | String | 0 | 0 | 160 | SMS Text |
| 50240 | Uint8 | 0 | 0 | 3 | Axis Z Priority |
| 50241 | Uint8 | 3 | 0 | 6 | Axis Z Operand |
| 50242 | Uint16 | 0 | -8000 | 8000 | Axis Z High level |
| 50243 | Uint16 | 0 | -8000 | 8000 | Axis Z Low level |
| 50244 | Uint8 | 0 | 0 | 1 | Axis Z Event only |
| 50245 | Uint16 | 1 | 0 | 65535 | Axis Z Average |
| 7024 | Uint8 | 0 | 0 | 10 | Send SMS |
| 8024 | String | 0 | 0 | 160 | SMS Text |
| 50250 | Uint8 | 0 | 0 | 3 | ICCID Priority |
| 50251 | Uint8 | 3 | 0 | 6 | ICCID Operand |
| 50254 | Uint8 | 0 | 0 | 1 | ICCID Event only |
| 7069 | Uint8 | 0 | 0 | 10 | Send SMS |
| 8069 | String | 0 | 0 | 160 | SMS Text |
| 50260 | Uint8 | 0 | 0 | 3 | SD Status Priority |
| 50261 | Uint8 | 3 | 0 | 6 | SD Status Operand |
| 50262 | Uint8 | 0 | 0 | 1 | SD Status High level |
| 50263 | Uint8 | 0 | 0 | 1 | SD Status Low level |
| 7070 | Uint8 | 0 | 0 | 10 | Send SMS |
| 8070 | String | 0 | 0 | 160 | SMS Text |
| 50510 | Uint8 | 0 | 0 | 3 | Eco Score Priority |
| 50511 | Uint8 | 3 | 0 | 6 | Eco Score Operand |
| 50512 | Uint8 | 0 | 0 | 1 | Eco Score High level |
| 50513 | Uint8 | 0 | 0 | 1 | Eco Score Low level |
| 50514 | Uint8 | 0 | 0 | 1 | Eco Score Event only |
| 7220 | Uint8 | 0 | 0 | 10 | Send SMS |
| 8220 | String | 0 | 0 | 160 | SMS Text |

7.13 OBD II (Bluetooth)

7.13.1 1st OBD II (Bluetooth) property parameter priority (ID=40100)

Parameter defines OBD II property type of priority: 0 is disabled, 1 – low, 2 – high, 3 - panic.

| Minimum value | Maximum value | Default value | Goes with (depends on) parameters | Value type |
|---------------|---------------|---------------|---|------------|
| 0 | 3 | 0 | 1st OBD II (Bluetooth) property parameter operand (ID=40101) 1st OBD II (Bluetooth) property parameter High level (ID=40102) 1st OBD II (Bluetooth) property parameter Low level (ID=40103) 1st OBD II (Bluetooth) property parameter Event only (ID=40104) 1st OBD II (Bluetooth) property parameters Send SMS to (ID=7038) 1st OBD II (Bluetooth) property parameters SMS Text (ID=8038) | Uint8 |

7.13.2 1st OBD II (Bluetooth) property parameter operand (ID=40101)

Parameter defines when event is sent: 0 – on range exit, 1 – on range entrance, 2 – both, 3 – monitoring, 4 – hysteresis, 5 – on changes, 6 – on delta change.

| Minimum value | Maximum value | Default value | Goes with (depends on) parameters | Value type |
|---------------|---------------|---------------|--|------------|
| 0 | 6 | 3 | 1st OBD II (Bluetooth) property parameter priority (ID=40100) 1st OBD II (Bluetooth) property parameter High level (ID=40102) 1st OBD II (Bluetooth) property parameter Low level (ID=40103) 1st OBD II (Bluetooth) property parameter Event only (ID=40104) 1st OBD II (Bluetooth) property parameters Send SMS to (ID=7038) 1st OBD II (Bluetooth) property parameters SMS Text (ID=8038) | Uint8 |

7.13.3 1st OBD II (Bluetooth) property parameter High level (ID=40102)

Parameter defines high value of triggered OBD II property. This parameter is used to set thresholds for OBD II properties to generate events.

| Minimum value | Maximum value | Default value | Goes with (depends on) parameters | Value type |
|---------------|---------------|---------------|---|------------|
| 0 | 255 | 0 | 1st OBD II (Bluetooth) property parameter priority (ID=40100) 1st OBD II (Bluetooth) property parameter operand (ID=40101) 1st OBD II (Bluetooth) property parameter Low level (ID=40103) 1st OBD II (Bluetooth) property parameter Event only (ID=40104) 1st OBD II (Bluetooth) property | Uint8 |

| | | | | |
|--|--|--|--|--|
| | | | parameters Send SMS to (ID=7038) 1st OBD II (Bluetooth) property parameters SMS Text (ID=8038) | |
|--|--|--|--|--|

7.13.4 1st OBD II (Bluetooth) property parameter Low level (ID=40103)

Parameter defines low value of triggered OBD II property. This parameter is used to set thresholds for OBD II properties to generate events.

| Minimum value | Maximum value | Default value | Goes with (depends on) parameters | Value type |
|---------------|---------------|---------------|--|------------|
| 0 | 255 | 0 | 1st OBD II (Bluetooth) property parameter priority (ID=40100) 1st OBD II (Bluetooth) property parameter operand (ID=40101) 1st OBD II (Bluetooth) property parameter High level (ID=40102) 1st OBD II (Bluetooth) property parameter Event only (ID=40104) 1st OBD II (Bluetooth) property parameters Send SMS to (ID=7038) 1st OBD II (Bluetooth) property parameters SMS Text (ID=8038) | Uint8 |

7.13.5 1st OBD II (Bluetooth) property parameter Event only (ID=40104)

Parameter defines when OBD II element value is sent: 0 – with every AVL packet, 1 – on event only. On event means that OBD II element value is included to AVL packet only when this particular event happens. With regular, periodic records such OBD II element value is not included.

| Minimal value | Maximum value | Default value | Goes with (depends on) parameters | Value type |
|---------------|---------------|---------------|---|------------|
| 0 | 1 | 0 | 1st OBD II (Bluetooth) property parameter priority (ID=40100) 1st OBD II (Bluetooth) property parameter operand (ID=40101) 1st OBD II (Bluetooth) property parameter High level (ID=40102) 1st OBD II (Bluetooth) property parameter Low level (ID=40103) 1st OBD II (Bluetooth) property parameters Send SMS to (ID=7038) 1st OBD II (Bluetooth) property parameters SMS Text (ID=8038) | Uint8 |

7.13.6 1st OBD II (Bluetooth) property parameters Send SMS to (ID=7038)

Enable/Disable SMS event sending. 0 – Disable, 1-10 SMS will be sent to configured GSM number.

| Minimal value | Maximum value | Default value | Goes with (depends on) parameters | Value type |
|---------------|---------------|---------------|---|------------|
| 0 | 10 | 0 | GSM Predefined Numbers (ID=6000-6009) 1st OBD II (Bluetooth) property parameter priority (ID=40100) 1st OBD II (Bluetooth) property parameter operand (ID=40101) 1st OBD II (Bluetooth) property parameter High level (ID=40102) 1st OBD II (Bluetooth) property parameter Low level (ID=40103) 1st OBD II (Bluetooth) property parameter Event only (ID=40104) 1st OBD II (Bluetooth) property parameters SMS Text (ID=8038) | Uint8 |

7.13.7 1st OBD II (Bluetooth) property parameters SMS Text (ID=8038)

Configure 1st OBD II (Bluetooth) I/O SMS event text here.

| Minimal value | Maximum value | Default value | Goes with (depends on) parameters | Value type |
|---------------|---------------|---------------|---|------------|
| 0 | 160 | Number of DTC | 1st OBD II (Bluetooth) property parameter priority (ID=40100) 1st OBD II (Bluetooth) property parameter operand (ID=40101) 1st OBD II (Bluetooth) property parameter High level (ID=40102) 1st OBD II (Bluetooth) property parameter Low level (ID=40103) 1st OBD II (Bluetooth) property parameter Event only (ID=40104) 1st OBD II (Bluetooth) property parameters Send SMS to (ID=7038) | S8[160] |

7.13.8 All OBD II (Bluetooth) I/O elements parameters property ID

| Parameter Name | Priority | Operand | High level | Low level | Event only | Send SMS to | SMS text |
|---------------------|----------|---------|------------|-----------|------------|-------------|----------|
| Number Of DTC | 40100 | 40101 | 40102 | 40103 | 40104 | 7038 | 8038 |
| Engine Load | 40110 | 40111 | 40112 | 40113 | 40114 | 7039 | 8039 |
| Coolant Temperature | 40120 | 40121 | 40122 | 40123 | 40124 | 7040 | 8040 |
| Short Fuel Trim | 40130 | 40131 | 40132 | 40133 | 40134 | 7041 | 8041 |
| Fuel Pressure | 40140 | 40141 | 40142 | 40143 | 40144 | 7042 | 8042 |
| Intake Map | 40150 | 40151 | 40152 | 40153 | 40154 | 7043 | 8043 |
| Engine RPM | 40160 | 40161 | 40162 | 40163 | 40164 | 7044 | 8044 |
| Vehicle speed | 40170 | 40171 | 40172 | 40173 | 40174 | 7045 | 8045 |

| Parameter Name | Priority | Operand | High level | Low level | Event only | Send SMS to | SMS text |
|-------------------------------------|----------|---------|------------|-----------|------------|-------------|----------|
| Timing advance | 40180 | 40181 | 40182 | 40183 | 40184 | 7046 | 8046 |
| Intake air temperature | 40190 | 40191 | 40192 | 40193 | 40194 | 7047 | 8047 |
| MAF | 40200 | 40201 | 40202 | 40203 | 40204 | 7048 | 8048 |
| Throttle position | 40210 | 40211 | 40212 | 40213 | 40214 | 7049 | 8049 |
| Run time since engine start | 40220 | 40221 | 40222 | 40223 | 40224 | 7050 | 8050 |
| Distance traveled MIL on | 40230 | 40231 | 40232 | 40233 | 40234 | 7051 | 8051 |
| Relative fuel rail pressure | 40240 | 40241 | 40242 | 40243 | 40244 | 7052 | 8052 |
| Direct fuel rail pressure | 40250 | 40251 | 40252 | 40253 | 40254 | 7053 | 8053 |
| Commanded EGR | 40260 | 40261 | 40262 | 40263 | 40264 | 7054 | 8054 |
| EGR error | 40270 | 40271 | 40272 | 40273 | 40274 | 7055 | 8055 |
| Fuel level | 40280 | 40281 | 40282 | 40283 | 40284 | 7056 | 8056 |
| Distance traveled since codes clear | 40290 | 40291 | 40292 | 40293 | 40294 | 7057 | 8057 |
| Barometric pressure | 40300 | 40301 | 40302 | 40303 | 40304 | 7058 | 8058 |
| Control module voltage | 40310 | 40311 | 40312 | 40313 | 40314 | 7059 | 8059 |
| Absolute load value | 40320 | 40321 | 40322 | 40323 | 40324 | 7060 | 8060 |
| Ambient air temperature | 40330 | 40331 | 40332 | 40333 | 40334 | 7061 | 8061 |
| Time run with MIL on | 40340 | 40341 | 40342 | 40343 | 40344 | 7062 | 8062 |
| Time since trouble codes cleared | 40350 | 40351 | 40352 | 40353 | 40354 | 7063 | 8063 |
| Absolute fuel rail pressure | 40360 | 40361 | 40362 | 40363 | 40364 | 7064 | 8064 |
| Hybrid battery pack remaining life | 40370 | 40371 | 40372 | 40373 | 40374 | 7065 | 8065 |
| Engine oil temperature | 40380 | 40381 | 40382 | 40383 | 40384 | 7066 | 8066 |
| Fuel injection timing | 40390 | 40391 | 40392 | 40393 | 40394 | 7067 | 8067 |
| Fuel Rate | 40400 | 40401 | 40402 | 40403 | 40404 | 7068 | 8068 |

8 MOUNTING RECOMMENDATIONS

8.1 Connecting Wires

- Wires should be fastened to the other wires or non-moving parts. Try to avoid heat emitting and moving objects near the wires.
- The connections should not be seen very clearly. If factory isolation was removed while connecting wires, it should be applied again.
- If the wires are placed in the exterior or in places where they can be damaged or exposed to heat, humidity, dirt, etc., additional isolation should be applied.
- Wires cannot be connected to the board computers or control units.

8.2 Connecting Power Source

- Be sure that after the car computer falls asleep, power is still available on chosen wire. Depending on car, this may happen in 5 to 30 minutes period.
- When module is connected, measure voltage again to make sure it did not decrease.
- It is recommended to connect to the main power cable in the fuse box.
- Use 3A, 125V external fuse.

8.3 Connecting Ignition Wire

- Be sure to check if it is a real ignition wire – power does not disappear while starting the engine.
- Check if this is not an ACC wire (when key is in the first position, most electronics of the vehicle are available).
- Check if power is still available when you turn off any of vehicles devices.
- Ignition is connected to the ignition relay output. As alternative, any other relay, which has power output when ignition is on, may be chosen.

8.4 Connecting Ground Wire

- Ground wire is connected to the vehicle frame or metal parts that are fixed to the frame.
- If the wire is fixed with the bolt, the loop must be connected to the end of the wire.
- For better contact scrub paint from the place where loop is connected.



PAY ATTENTION! Connecting the power supply must be carried out in a very low impedance point of on-board vehicle network. These points in the car are the battery terminals. Therefore, we recommend connecting the power of FMB920 (GND and POWER wires) directly to the battery terminals. Another valid option is to connect the wires to the main POWER cable inside the fuse box (if there is none, then to the power supply where the fuses of vehicle's computer are), GND wire must be connected in a special point, designed to connect GND vehicle computer. Connecting the GND at an arbitrary point to the mass of the car is unacceptable, as static and dynamic potentials on the line GND will be unpredictable, which can lead to unstable FMB920 operation and even its failure.

9 FMB920 installation instruction

FMB920 is the device that has internal GNSS and GSM antenna.

Device should be mounted with the sticker view to the open sky (metal free). FMB920 area with sticker and GNSS antenna is shown in figure 25.

Figure 50 FMB920 view

Most light vehicles has oblique front window that opens most part of interior front panel.

FMB920 can be mounted under the plastic panel behind the front window, with the sticker direction to a window (sky). It is recommended to place FMB920 behind dashboard as close to the window as possible. A good example of GNSS antenna placement is displayed in a picture below (area colored green).

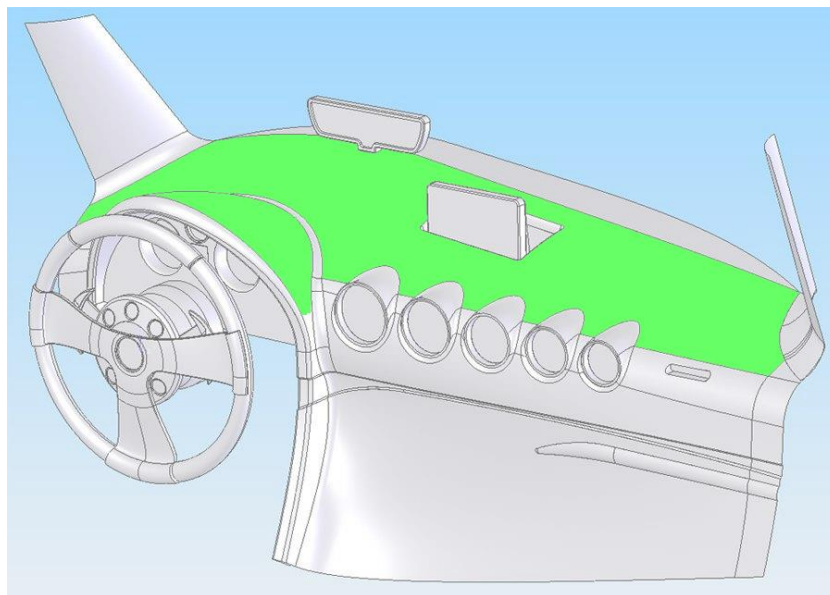

Figure 51 Correct placement of FMB920

10 EC Declaration of Conformity



Saltoniskiu st. 10C,
LT-08105 Vilnius

Tel. +370 5 212 7472
Fax. +370 5 276 1380

www.teltonika.lt
info@teltonika.lt

EC Declaration of Conformity

Declaring Organization: UAB TELTONIKA

Saltoniskiu st. 10c
LT-08105, Vilnius, Lithuania
Tel: +370 5 212 74 72
Email: info@teltonika.lt
www.teltonika.eu

Product Name: Fleet Management System
Product Model Name: FMB900, FMB920, IOT100, IOT120
Product Description: GNSS/GSM tracker

Technical description of built in RF module:

| Frequency range: | Tx: | Rx: |
|------------------|---------------------|-------------------------|
| GSM900: | 880MHz - 915MHz | 925MHz - 960MHz |
| GSM1800: | 1710MHz - 1785MHz | 1805MHz - 1880MHz |
| Bluetooth | 2400MHz - 2483,5MHz | 2400MHz - 2483,5MHz |
| GPS | / | 1575,42 MHz |
| GLONASS | / | 1602,56MHz - 1615,50MHz |

Transmitted Power: Max. 32,84 dBm (GSM900)

Hardware Version: TM2500_01

Software Version: TM25_D_00.00.01.00

JSC TELTONIKA
Saltoniskiu st. . 10C, LT-08105 Vilnius

Company code 124429895
VAT identification number LT244-298917

JSC Svedbank, Vilnius
LT51 7300 0100 8737 2567



We, UAB TELTONIKA, declare under our sole responsibility that the above described product is in conformity with the relevant Community harmonisation: European Directive 2014/53/EU (RED).

The conformity with the essential requirements has been demonstrated against the following harmonized standards:

| Harmonized Standard reference | Article of Directive 2014/53/EU | Test report No. |
|---|--|--|
| EN 60950-1:2006 + A1:2010 + A2:2013 + A11:2009 + A12:2011 | Health and safety - Article 3.1(a) | T223-0020/17 |
| EN 62311:2008 | | RXA1706-0196EMF |
| Draft EN 301 489-1 V2.2.0 Draft EN 301 489-17 V3.2.0 Draft EN 301 489-19 V2.1.0 Draft EN 301 489-52 V1.1.0 | Electromagnetic compatibility - Article 3.1(b) | T251-0538/17 |
| EN 301 511 V9.0.2 EN 300 328 V2.1.1 Draft EN 303 413 V1.1.0 | Efficient use of radio spectrum - Article 3.2 | RXA1706-0196RF03 RXA1706-0196RF01 RXA1706-0196RF02 |

The conformity assessment procedure referred to in Article 17 and detailed in Annex III of Directive 2014/53/EU has been followed with the involvement of the following Notified Body: SIQ Ljubljana, Mašera-Spasičeva ulica 10, SI-1000 Ljubljana, Slovenia. Notified Body No: 1304.

Thus,  is placed on the product.

Vilnius, 2017-09-14

 Chief of Technical Support Department
 Karolina Juciute

 Project Manager
 Aleksandr Krupovich



EU-Type Examination Certificate No. 1304-RED-0017 Technical Documentation: FMB9X0 User Manual v0.25

11 CHANGE LOG

| Nr. | Date | Version | Comments |
|-----|------------|---------|--|
| 1 | 2016-08-25 | 0.01 | Preliminary draft release. |
| 2 | 2016-10-31 | 0.02 | Preliminary draft release update. |
| 3 | 2016-11-10 | 0.03 | Preliminary draft release update. |
| 4 | 2016-11-17 | 0.04 | Removed internal comments. |
| 5 | 2016-12-06 | 0.05 | Formating changes |
| 6 | 2016-12-12 | 0.06 | 4.4.6 Crash Trace operation updated |
| 7 | 2016-12-12 | 0.07 | Fixed for LVD certification |
| 8 | 2016-12-19 | 0.08 | Added Bluetooth connection info. MicroSD insert info. SMS Event Time Zone configuration description. Crash Trace example. |
| 9 | 2017-01-07 | 0.09 | Added setdigout SMS command explanation. |
| 10 | 2017-01-09 | 0.10 | Added caution note about DOUT. |
| 11 | 2017-01-31 | 0.11 | Updated software requirements. |
| 12 | 2017-02-02 | 0.12 | Added SELV limited power source line. |
| 13 | 2017-02-15 | 0.13 | Added Towing, Unplug detection. Bluetooth description, Dout control via call, GNSS fuel counter, Excessive idling, Eco driving. SMS ID. |
| 14 | 2017-02-21 | 0.14 | Updated IO elements SMS ID description. |
| 15 | 2017-03-06 | 0.15 | Correction in setdigout command explanation |
| 16 | 2017-03-23 | 0.16 | Correction AutoGeofence event generating SMS ID. Added Note: SIM card insertion/removal Added Terminal log description. Added OBD II Bluetooth Dongle description Added Bluetooth Hands Free description Added device debug over Android smartphone |
| 17 | 2017-03-24 | 0.17 | Added SMS command "btgetlist" description. Added "Min Saved Records" and "Send Period" ID. Added "Unplug Detection" parameters value. |
| 18 | 2017-03-29 | 0.18 | Correction microSD description Added "\O elements parameters and types" |
| 19 | 2017-03-31 | 0.19 | Correction Crash Detection SMS ID Correction "setparam" SMS command description. Correction "Crash Trace" description. |
| 20 | 2017-04-06 | 0.20 | Correction "Deep Sleep" description. Added LED indicator status description. |
| 21 | 2017-04-19 | 0.21 | Correction "Technical details" description. Correction "getparam" and "setparam" description. Correction "Green driving" parameters values. Correction "Idling" parameters ID. GNSS status IO element Hi Level Max value updated. |

| | | | |
|----|------------|------|---|
| | | | Added I\O elements ICCID and SD status. Added "Synchronization settings" parameters values. |
| 22 | 2017-04-27 | 0.22 | Minor changes Correction "AutoGeofencing" parameters values. Added SMS ID "Towing Detection" |
| 23 | 2017-05-25 | 0.23 | Added Note: Firmware downgrade. Added Note: Operand On Delta Change Minor changes Battery description. Correction "Green driving" parameters values. Correction "Green driving" description. Added BT "Data Link" description. Correction Value "GSM number index" Correction "getinfo" SMS command description. |
| 24 | 2017.07.21 | 0.24 | Ignition Source new values Online Deep Sleep mode Excessive Idling Keyword configuration with TCP Status info Security info Use authorized numbers to control DOUT via call DOUT control depending on functionality priority Manual Geofence IO Operand settings Commands "getio, countrecs, deleterecords, battery, fc_reset, obdinfo, faultcodes, setkey # #, delkey # #, log2sd #, #, #, #, bbread #, bbinfo #, sdformat" added Movement Start/Stop Delay(s) Backup Server parameters SMS Event Time Zone Hands Free Call Settings Green driving SMS parameters Jamming scenario parameters Trip SMS parameters DOUT control via call scenario parameters Excessive idling SMS parameters OBD II (Bluetooth) |
| 25 | 2017.07.26 | 0.25 | Updated Permaement I/O elements table |
| 26 | 2017.09.21 | 0.26 | Added EC Declaration of Conformity. Added weight information. |
| 27 | 2017.10.02 | 0.27 | Added Blacklist Operator list |
| 28 | 2017.10.20 | 0.28 | Minor changes Bluetooth description. |
| 28 | 2018.01.23 | 0.29 | Minor changes Power supply description. Correction "Static Navigation Settings" parameters values. Added battery warranty information. Delete the sms command "log2sd" |

| | | | |
|----|------------|------|--|
| | | | <p>Changed SMS Event time zone description Changed auto_calibrate description Correction "getinfo" description.</p> |
| 29 | 2018.02.27 | 0.30 | <p>Minor change "Ignition settings" description. Correction ID "Crash sms to". Correction ID "SMS Text". Added GPRS authentication description. Added Green Driving Duration description. Correction "Energy consumption" values. Added Ultra Deep Sleep mode description.</p> |