

MEITRACK MVT380 User Guide



Change History

File Name	MEITRACK MVT380 User Guide	Created By	Kyle Lv
Project	MVT380	Creation Date	2010-08-24
		Update Date	2017-03-24
Subproject	User Guide	Total Pages	15
Version	V3.4	Confidential	External Documentation

Contents

1 Copyright and Disclaimer	- 4 -
2 Product Overview	- 4 -
3 Product Functions and Specifications	- 4 -
3.1 Product Functions	- 4 -
3.1.1 Position Tracking	- 4 -
3.1.2 Anti-Theft	- 4 -
3.1.3 Other Functions	- 5 -
3.1.4 Functions of Optional Accessories	- 5 -
3.2 Specifications	- 5 -
4 MVT380 and Accessories	- 6 -
5 Appearance	- 6 -
6 First Use	- 6 -
6.1 Installing the SIM Card	- 6 -
6.2 Charging the Device	- 7 -
6.3 LED Indicator	- 7 -
6.4 Configuring Device Parameters by Meitrack Manager	- 7 -
6.5 Tracking by Mobile Phone	- 8 -
6.6 Common SMS Commands	- 9 -
6.6.1 Setting Authorized Phone Numbers – A71	- 9 -
6.6.2 Setting Listen-in Phone Numbers – A72	- 10 -
6.6.3 Setting the Smart Sleep Mode – A73	- 10 -
7 Logging In to MS03 Tracking System	- 10 -
8 Installing the MVT380	- 11 -
8.1 Installing GPS and GSM Antennas	- 11 -
8.2 Installing an I/O Cable	- 11 -
8.2.1 Power Cable/Ground Wire (Pin 7/8)	- 13 -
8.2.2 Digital Input (Pin 1/2/3, Negative Trigger)	- 13 -
8.2.3 Digital Input (Pin 4/5, Positive Trigger)	- 14 -
8.2.4 Output Control (Pin 9/10/11/12/13)	- 14 -
8.2.5 Voltage Formula for the Built-in Battery and External Power Supply	- 14 -
8.2.6 Analog Input (Pin 6/14)	- 14 -
8.3 (Optional) Installing the Microphone and Speaker	- 15 -
8.4 Mounting the MVT380	- 15 -

1 Copyright and Disclaimer

Copyright © 2017 MEITRACK. All rights reserved.

 and  are trademarks that belong to Meitrack Group.

The user manual may be changed without notice.

Without prior written consent of Meitrack Group, this user manual, or any part thereof, may not be reproduced for any purpose whatsoever, or transmitted in any form, either electronically or mechanically, including photocopying and recording.

Meitrack Group shall not be liable for direct, indirect, special, incidental, or consequential damages (including but not limited to economic losses, personal injuries, and loss of assets and property) caused by the use, inability, or illegality to use the product or documentation.

2 Product Overview

The MVT380, an anti-theft vehicle tracker, is specially designed for high-end vehicles to implement real-time monitoring and provide protection with GPS/GSM/GPRS functions and high stability. The device applies for vehicle tracking and fleet management. It has the following functions:

- Remote listen-in
- Two-way calling
- Geo-fence alarm
- Speeding alarm
- Polygonal geo-fence alarm
- Towing alarm

It has a built-in 8 MB buffer, which supports automatic storage of GPRS data packets when no GSM signal exists and supports automatic data packet sending after the GSM signal recovers.

3 Product Functions and Specifications

3.1 Product Functions

3.1.1 Position Tracking

- GPS + GSM positioning
- Real-time location query
- Track by time interval
- Track by distance
- Track by mobile phone
- Speeding alarm
- Cornering report

3.1.2 Anti-Theft

- SOS alarm
- GPS antenna cut-off alarm
- External power cut-off alarm

- GPS blind spot alarm
- Remote vehicle fuel/power cut-off
- Engine or vehicle door status alarm
- Towing alarm
- Geo-fence alarm

3.1.3 Other Functions

- SMS/GPRS (TCP/UDP) communication (Meitrack protocol)
- Built-in 8 MB buffer for recording driving routes
- Mileage report
- Low power alarm for internal battery
- Over-the-Air (OTA) update
- Avoiding static drift by checking the engine

3.1.4 Functions of Optional Accessories

Accessory	Function
Microphone and speaker	Remote listen-in and two-way calling

3.2 Specifications

Item	Specifications
Dimension	105 mm x 65 mm x 26 mm
Weight	190g
Power supply	DC 11–36 V/1.5 A
Backup battery	400 mAh/3.7 V
Power consumption	Current in standby mode: 65 mA
Operating temperature	-20°C to 55°C
Operating humidity	5% to 95%
Working hour	80 hours in power-saving mode 5.7 hours in normal mode
LED indicator	2 indicators showing GSM and GPS status
Button/Switch	1 SOS button (for sending SMSs or dialing) 1 power button
Memory	8 MB buffer
Sensor	3-axis accelerometer (used to wake the device up by vibration and detect towing alarms)
Frequency band	GSM 850/900/1800/1900 MHz
GPS sensitivity	-161 dB
Positioning accuracy	10m
I/O port	5 digital inputs (3 negative inputs and 2 positive inputs) 2 analog detection inputs 5 outputs

	1 USB port 1 speaker or microphone
--	---------------------------------------

4 MVT380 and Accessories



MVT380 with a built-in battery



GPS antenna



GSM antenna



I/O cable + SOS button



USB cable



CD download card

5 Appearance

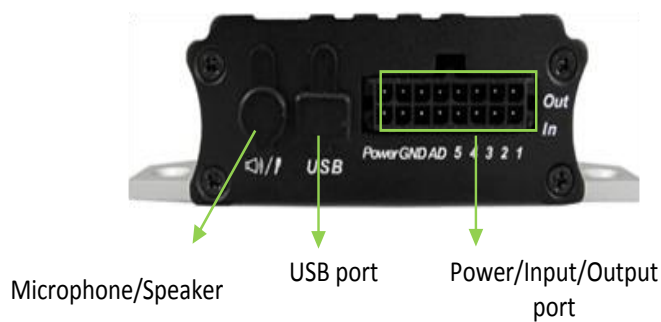
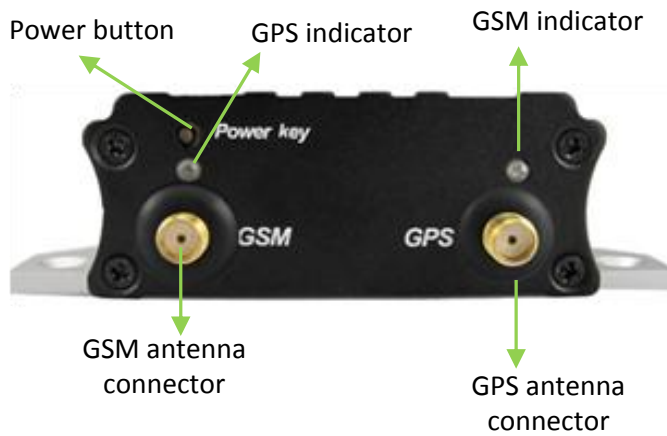

6 First Use

6.1 Installing the SIM Card

1. Loosen the screws, and remove the front cover of the device.

2. Insert the SIM card into the card slot with its gold-plated contacts facing towards the Printed Circuit Board (PCB).
3. Close the cover, and tighten the screws.

Note:

- Power off the device before installing the SIM card.
- Ensure that the SIM card has sufficient balance.
- Ensure that the phone card PIN lock has been closed properly.
- Ensure that the SIM card in the device has subscribed the caller ID service if you want to use your authorized phone number to dial the SIM card.



6.2 Charging the Device

When you use the device for the first time, connect the device's GND (-Black) and Power (+Red) wires to 12 V or 24 V external power supply for charging. Ensure that the device is charged at least three hours. Eight hours are recommended.

The device can be installed on a vehicle only after it is configured and tested.

6.3 LED Indicator

Press and hold down the power button for 3–5 seconds to start the device.

GPS Indicator (Blue)	
Steady on	A button or an input is triggered.
Blink (every 0.1 seconds)	The device is being initialized or the battery power is low.
Blink (0.1 seconds on and 2.9 seconds off)	A GPS signal is received.
Blink (1 second on and 2 seconds off)	No GPS signal is received.
GSM Indicator (Green)	
Steady on	A call is coming in or a call is being made.
Blink (every 0.1 seconds)	The device is being initialized.
Blink (0.1 seconds on and 2.9 seconds off)	A GSM signal is received.
Blink (1 second on and 2 seconds off)	No GSM signal is received.

6.4 Configuring Device Parameters by Meitrack Manager

This section describes how to use Meitrack Manager to configure the device on a computer.

Procedure:

1. Install the USB-to-serial cable driver and Meitrack Manager.
2. Connect the device to a computer with the USB-to-serial cable.



3. Run Meitrack Manager, then the following dialog box will appear:



Turn on the device, then Meitrack Manager will detect the device model automatically and the parameter page will appear accordingly.

For details about Meitrack Manager, see the *MEITRACK Manager User Guide*.

6.5 Tracking by Mobile Phone

Call or send the **0000,A00** command by SMS to the device's SIM card number. The device will reply to an SMS with a map link. Click the SMS link. The device's location will be displayed on Google Maps on your mobile phone.

Note: Ensure that the device's SIM card number has subscribed the caller ID service. Otherwise, the tracking function by mobile phone will be unavailable.



SMS example:

Now,110727 02:48,V,16,23Km/h,61%,http://maps.google.com/maps?f=q&hl=en&q=22.540103,114.082329

The following table describes the SMS format:

Parameter	Description	Remarks
Now	Indicates the current location.	SMS header: indicates the current location or the alarm type.
110727 02:48	Indicates the date and time in	None

	YYMMDD hh:mm format.	
V	The GPS is invalid.	A = Valid V = Invalid
16	Indicates the GSM signal strength.	Value: 1–32 The larger the value is, the stronger the signal is. If the value is greater than 12, GPRS reaches the normal level.
23Km/h	Indicates the speed.	Unit: km/h
61%	Indicates the remaining battery power.	None
http://maps.google.com/ maps?f=q&hl=en&q=22.5 40103,114.082329	Indicates the map link. Latitude: 22.540103 Longitude: 114.082329	None

If your mobile phone does not support HTTP, enter the latitude and longitude on Google Maps to query a location.

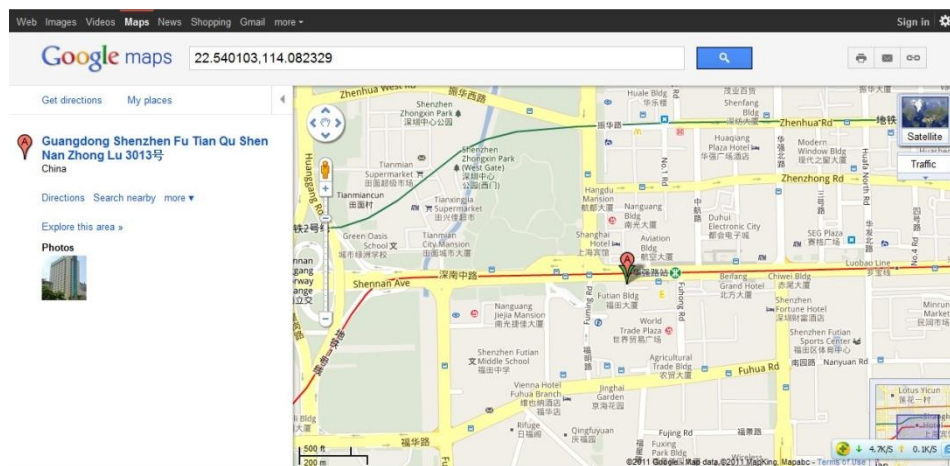

6.6 Common SMS Commands

6.6.1 Setting Authorized Phone Numbers – A71

SMS sending: 0000,A71,Phone number 1,Phone number 2,Phone number 3

SMS reply: IMEI,A71,OK

Description:

Phone number: A phone number has a maximum of 16 bytes. If no phone numbers are set, leave them blank. Phone numbers are empty by default.

Phone number 1/2/3: SOS phone numbers. When you call the tracker by using these phone numbers, you will receive SMS notification about the location, geo-fence alarm and low power alarm.

If you need to delete all authorized phone numbers, send **0000,A71**.

When the SOS button is pressed, the tracker dials phone numbers 1, 2, and 3 in sequence. The tracker stops dialing when a phone number responds.

Example:

Sending: 0000,A71,13811111111,13822222222,13833333333

Reply: 353358017784062,A71,OK

6.6.2 Setting Listen-in Phone Numbers – A72

SMS sending: 0000,A72,Listen-in phone number 1,Listen-in phone number 2

SMS reply: IMEI,A72,OK

Description:

When you call the tracker by using the authorized listen-in phone number, the tracker will answer the call automatically and enter the listen-in state. In this way, the tracker will not make any sound.

A maximum of two phone numbers can be set. Each phone number has a maximum of 16 digits. If no phone numbers are set, leave them blank. Phone numbers are empty by default.

If no phone numbers are set and commas are remained, phone numbers set before will be deleted.

If you need to delete all listen-in phone numbers, send **0000,A72**.

Example:

Sending: 0000,A72,13844444444,13855555555

Reply: 353358017784062,A72,OK

6.6.3 Setting the Smart Sleep Mode – A73

SMS sending: 0000,A73,Sleep level

SMS reply: IMEI,A73,OK

Description:

When the sleep level is **0** (default value), disable the sleep mode.

When the sleep level is **1**, the tracker enters the normal sleep mode. The GSM module always works, and the GPS module occasionally enters the sleep mode. The tracker works 25% longer in the normal sleep mode than that in the normal working mode. This mode is not recommended for short interval tracking; this will affect the route precision.

When the sleep level is **2**, the tracker enters deep sleep mode. If no event (SOS, button changes, incoming calls, SMSs, or vibration) is triggered after five minutes, the GPS module will stop, and the GSM module will enter sleep mode. Once an event is triggered, the GPS and GSM modules will be woken up.

Note: In any condition, you can use an SMS or a GPRS command to disable the sleep mode, and then the tracker exits the sleep mode and returns back to the normal working mode.

Example:

Sending: 0000,A73,2

Reply: 353358017784062,A73,OK

For details about SMS commands, see the *MEITRACK SMS Protocol*.

Note:

1. The default SMS command password is **0000**. You can change the password by using Meitrack Manager and SMS command.
2. The device can be configured by SMS commands with a correct password. After an authorized phone number is set, only the authorized phone number can receive the preset SMS event report.

7 Logging In to MS03 Tracking System

Visit <http://ms03.trackingmate.com>, enter the user name and password, and log in to the MS03. (Purchase the login account from your provider.)

For more information about how to add a tracker, see the *MEITRACK GPS Tracking System MS03 User Guide* (chapter 4 "Getting Started").

The MS03 supports the following functions:

- Track by time interval or distance.
- Query historical trips.
- Set polygonal geo-fences.
- Bind driver and vehicle information.
- View various reports.
- Send commands in batches.
- Support OTA updates.

For details, see the *MEITRACK GPS Tracking System MS03 User Guide*.

8 Installing the MVT380

8.1 Installing GPS and GSM Antennas

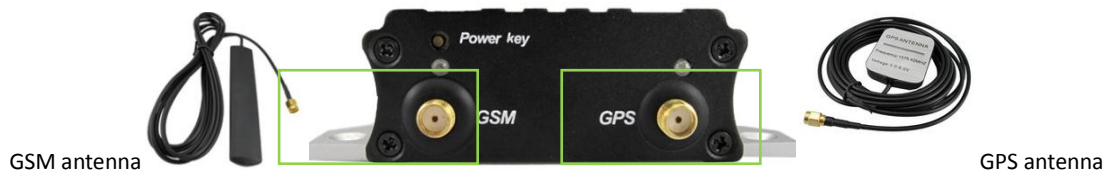

Connect the GSM antenna to the connector which is labeled "GSM". The GSM antenna is non-directional, so you can hide it in any place of a vehicle.

Connect the GPS antenna to the connector which is labeled "GPS". It is recommended that the antenna is facing up to the sky and the antenna side with words is downwards. Secure the antenna by using double sided tapes.

Note: Do not install the GPS antenna at a metal covered place.

8.2 Installing an I/O Cable

The I/O cable is a 16-pin cable, including the power, analog input, positive input, negative input, and output interfaces.

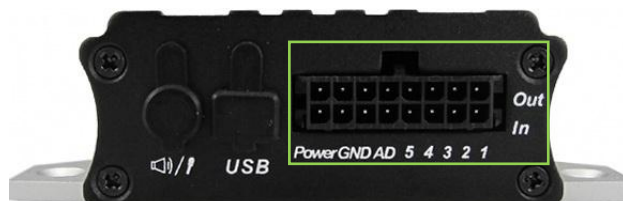

16	15	14	13	12	11	10	9
Power output (+)	GND out (-)	AD Input 2	Output 5	Output 4	Output 3	Output 2	Output 1
8	7	6	5	4	3	2	1
Power input (+)	GND in (-)	AD Input 1	Input 5 (+)	Input 4 (+)	Input 3 (-)	Input 2 (-)	Input 1 (-)

Pin Number	Color	Description
1 (IN1)	White	Digital input 1, negative trigger (SOS button by default)
2 (IN2)	White	Digital input 2 (negative trigger) Connect to a door trigger signal cable to detect vehicle door status. (Most Chinese, Korean, and Japanese cars are negative edge-triggered.)

3 (IN3)	White	Digital input 3 (negative trigger) Detect vehicle door status. (Most Chinese, Korean, and Japanese cars are negative edge-triggered.)
4 (IN4)	White	Digital input 4 (positive trigger) Connect to the vehicle ACC cable by default to detect the vehicle ACC status.
5 (IN5)	White	Digital input 5 (positive trigger) Connect to a door trigger signal cable to detect vehicle door status. (Most European and American cars are positive edge-triggered.)
6 (AD1)	Blue	Analog input 1 with 10-bit resolution and valid voltage of 0–6 V. Connect to an external sensor, such as the fuel level sensor and temperature sensor.
7 (GND)	Black	Ground wire, connected to the negative electrode of the vehicle battery or to the negative terminal.
8 (POWER)	Red	Positive electrode of the power input, connected to the positive electrode of the vehicle battery. Input voltage: 11–36 V. 12 V is recommended.
9 (OUT1)	Yellow	Output 1 Valid: low level (0 V) Invalid: open drain Maximum voltage for output open drain (invalid): 45 V Maximum current for output low voltage (valid): 500 mA Connect to an external relay to remotely cut off the vehicle fuel cable or engine power supply.
10 (OUT2)	Yellow	Output 2 Valid: low level (0 V) Invalid: open drain Maximum voltage for output open drain (invalid): 45 V Maximum current for output low voltage (valid): 500 mA Connect to an external relay to remotely cut off the vehicle fuel cable or engine power supply.
11 (OUT3)	Yellow	Output 3 Valid: low level (0 V) Invalid: open drain Maximum voltage for output open drain (invalid): 45 V Maximum current for output low voltage (valid): 500 mA Connect to an external relay to remotely cut off the vehicle fuel cable or engine power supply.
12 (OUT4)	Yellow	Output 4 Valid: low level (0 V) Invalid: open drain Maximum voltage for output open drain (invalid): 45 V Maximum current for output low voltage (valid): 500 mA Connect to an external relay to remotely cut off the vehicle fuel cable or engine power supply.
13 (OUT5)	Yellow	Output 5

		Valid: low level (0 V) Invalid: open drain Maximum voltage for output open drain (invalid): 45 V Maximum current for output low voltage (valid): 500 mA Connect to an external relay to remotely cut off the vehicle fuel cable or engine power supply.
14 (AD2)	Blue	Analog input 2 with 10-bit resolution and valid voltage of 0–6 V. Connect to an external sensor, such as the fuel level sensor and temperature sensor.
15 (GND)	Black	Ground wire It can be used as a ground wire connected to an analog sensor.
16 (POWER)	Red	Positive pole of the power output. The output voltage is equal to that of pin 8. Supplies power to an external device.

8.2.1 Power Cable/Ground Wire (Pin 7/8)

Connect the power cable (red) and ground wire (black) to the positive and negative electrodes of the vehicle battery respectively.

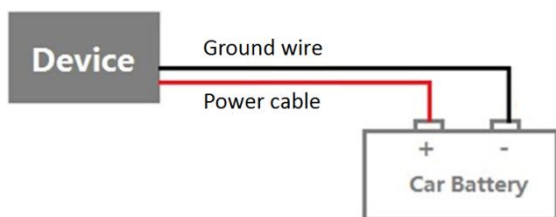

8.2.2 Digital Input (Pin 1/2/3, Negative Trigger)

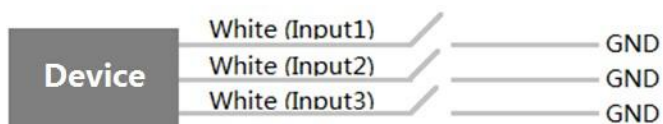

8.2.3 Digital Input (Pin 4/5, Positive Trigger)

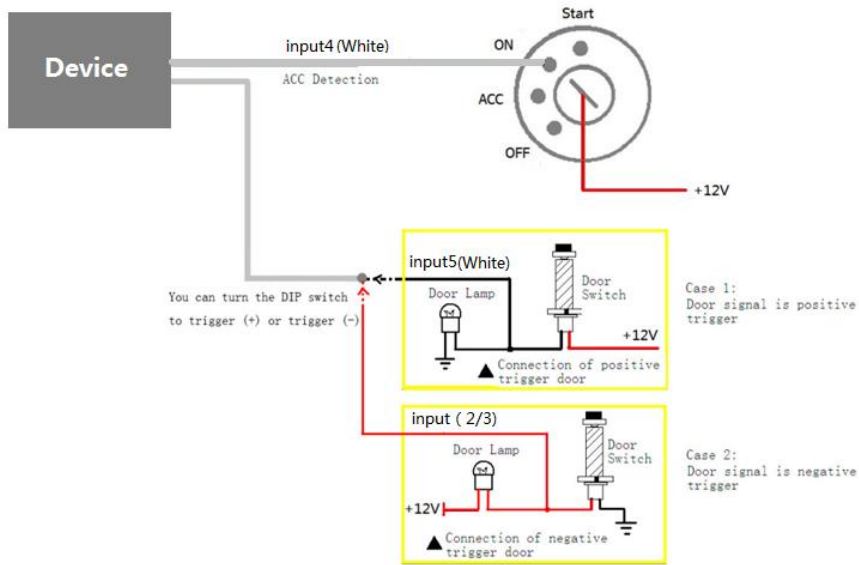

8.2.4 Output Control (Pin 9/10/11/12/13)

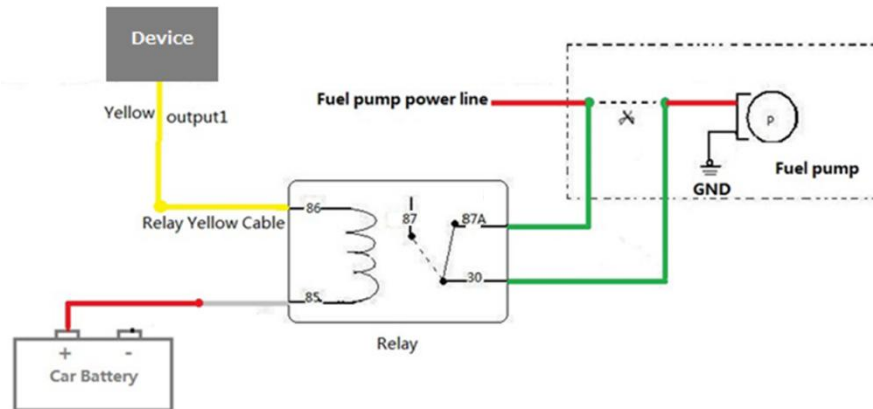

8.2.5 Voltage Formula for the Built-in Battery and External Power Supply

Built-in battery input voltage = $(AD4 \times 3 \times 2) / 1024$

Battery percentage = $[(AD4 - 2114) \times 100 / 492] \times 100\%$

External power supply input voltage = $AD5 / 1024 \times 3 \times 16$

8.2.6 Analog Input (Pin 6/14)

The AD analog input can connect to a sensor whose output voltage ranges from 0 V to 6.6 V.

AD analog voltage = $(AD \times 3 \times 2) / 1024$

8.3 (Optional) Installing the Microphone and Speaker

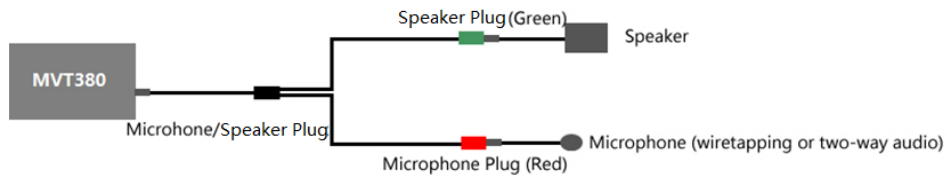

8.4 Mounting the MVT380

Tighten the four screws shown in the following figure.



If you have any questions, do not hesitate to email us at info@meitrack.com.